



Chipsmall Limited consists of a professional team with an average of over 10 year of expertise in the distribution of electronic components. Based in Hongkong, we have already established firm and mutual-benefit business relationships with customers from,Europe,America and south Asia,supplying obsolete and hard-to-find components to meet their specific needs.

With the principle of “Quality Parts,Customers Priority,Honest Operation,and Considerate Service”,our business mainly focus on the distribution of electronic components. Line cards we deal with include Microchip,ALPS,ROHM,Xilinx,Pulse,ON,Everlight and Freescale. Main products comprise IC,Modules,Potentiometer,IC Socket,Relay,Connector.Our parts cover such applications as commercial,industrial, and automotives areas.

We are looking forward to setting up business relationship with you and hope to provide you with the best service and solution. Let us make a better world for our industry!



## Contact us

Tel: +86-755-8981 8866 Fax: +86-755-8427 6832

Email & Skype: info@chipsmall.com Web: www.chipsmall.com

Address: A1208, Overseas Decoration Building, #122 Zhenhua RD., Futian, Shenzhen, China



## Network isolator - FL ISOLATOR 100-RJ/RJ - 2313931

Please be informed that the data shown in this PDF Document is generated from our Online Catalog. Please find the complete data in the user's documentation. Our General Terms of Use for Downloads are valid (<http://phoenixcontact.com/download>)



Passive network isolator for electrical isolation in Ethernet networks. This protects Ethernet devices from potential differences of up to 4 kV. Can be used for transmission speeds of up to 100 Mbps. Possible to connect two RJ45 plugs.

### Why buy this product

- ✓ No power supply required
- ✓ Dielectric strength of up to 4 kV
- ✓ Protection against aggressive environmental influences, particularly harsh industrial environments, thanks to coated PCB
- ✓ Approval for railway applications (rolling stock) according to EN 50155 and EN 50121
- ✓ Extended temperature range of -25°C to +85°C
- ✓ Continuous insulation voltage of 250 VRMS
- ✓ Electrical isolation of data cables and cable shielding
- ✓ Mounting on EN DIN rails



### Key Commercial Data

Packing unit	1 STK
GTIN	 4 046356 575089
GTIN	4046356575089

### Technical data

#### Dimensions

Width	22.5 mm
Height	99 mm
Depth	92 mm

#### Ambient conditions

Ambient temperature (operation)	-25 °C ... 75 °C
Ambient temperature (storage/transport)	-25 °C ... 85 °C
Permissible humidity (operation)	10 % ... 95 % (non-condensing)
Permissible humidity (storage/transport)	5 % ... 95 % (non-condensing)

# Network isolator - FL ISOLATOR 100-RJ/RJ - 2313931

## Technical data

### Ambient conditions

Altitude	5000 m (For restrictions see manufacturer's declaration)
Degree of protection	IP20

### General

Electrical isolation	Ethernet // Ethernet
Test voltage data interface/data interface	4 kV AC (50 Hz, 1 min.)
Insulation voltage input/output	250 V <sub>rms</sub>
Standards/regulations	EN 50121 and EN 50155 (for railway applications)
Electromagnetic compatibility	Conformance with EMC Directive 2014/30/EU
Net weight	118.9 g
Housing material	PA 6.6-FR
Color	green
MTBF	38062 Years (Telcordia standard, 25°C temperature, 21% operating cycle (5 days a week, 8 hours a day))
	12264 Years (Telcordia standard, 40°C temperature, 34.25% operating cycle (5 days a week, 12 hours a day))
UL, USA/Canada	508 Listed

### Serial interface

Interface 1	Ethernet interface, 10/100Base-T(X) in acc. with IEEE 802.3u
Interface	Ethernet
No. of ports	1
Connection method	RJ45 socket, shielded
Transmission length	≤ 100 m (Total length across both ports (dependent on data rate and cable used))
Serial transmission speed	10/100 Mbps
Interface 2	Ethernet interface, 10/100Base-T(X) in acc. with IEEE 802.3u
Interface	Ethernet
No. of ports	1
Connection method	RJ45 socket, shielded
Serial transmission speed	10/100 Mbps

### Standards and Regulations

Electromagnetic compatibility	Conformance with EMC Directive 2014/30/EU
Type of test	Vibration resistance in acc. with EN 60068-2-6/IEC 60068-2-6
Test result	5g, 10...150 Hz, 2.5 h, in XYZ direction
Type of test	Shock in acc. with EN 60068-2-27/IEC 60068-2-27
Test result	25g, 11 ms period, half-sine shock pulse
Standards/regulations	EN 61000-4-2
Contact discharge	± 6 kV (Test Level 3)
Standards/regulations	EN 61000-4-3
Frequency range	26 MHz ... 3 GHz (Test Level 3)
Standards/regulations	EN 61000-4-4

# Network isolator - FL ISOLATOR 100-RJ/RJ - 2313931

## Technical data

### Standards and Regulations

Comments	Criterion B
Standards/regulations	EN 61000-4-5
Signal	± 1 kV (Data line, asymmetrical)
Standards/regulations	EN 61000-6-4
	EN 61000-4-6
Frequency range	0.15 MHz ... 80 MHz
Standards/regulations	EN 50121 and EN 50155 (for railway applications)
UL, USA/Canada	508 Listed
Noxious gas test	ISA-S71.04-1985 G3 Harsh Group A

### Environmental Product Compliance

China RoHS	Environmentally friendly use period: unlimited = EFUP-e
	No hazardous substances above threshold values

## Drawings

Block diagram

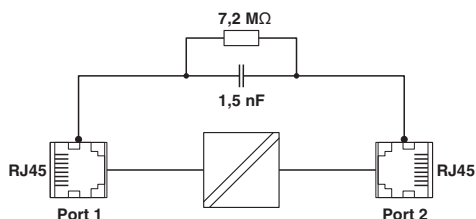

Dimensional drawing

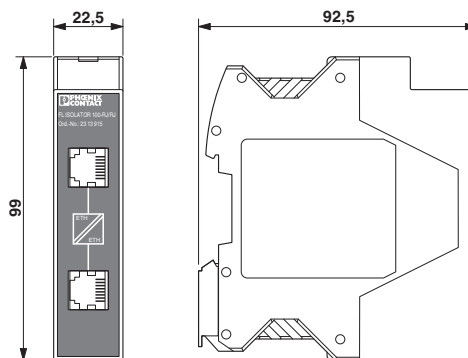

Schematic diagram

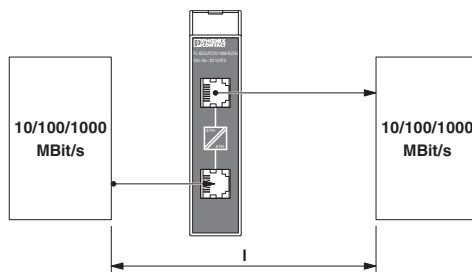

## Approvals

Approvals



# Network isolator - FL ISOLATOR 100-RJ/RJ - 2313931

## Approvals

Approvals

UL Listed / cUL Listed / EAC / DNV GL / cULus Listed

---

Ex Approvals

---

### Approval details

UL Listed		<a href="http://database.ul.com/cgi-bin/XYV/template/LISEXT/1FRAME/index.htm">http://database.ul.com/cgi-bin/XYV/template/LISEXT/1FRAME/index.htm</a>	FILE E 238705
-----------	---	---	---------------

cUL Listed		<a href="http://database.ul.com/cgi-bin/XYV/template/LISEXT/1FRAME/index.htm">http://database.ul.com/cgi-bin/XYV/template/LISEXT/1FRAME/index.htm</a>	FILE E 238705
------------	---	---	---------------

EAC			EAC-Zulassung
-----	---	--	---------------

DNV GL		<a href="http://exchange.dnv.com/tari/">http://exchange.dnv.com/tari/</a>	TAA00001KR
--------	--	---	------------

cULus Listed			
--------------	---	--	--

---

Phoenix Contact 2018 © - all rights reserved  
<http://www.phoenixcontact.com>

PHOENIX CONTACT GmbH & Co. KG  
Flachsmarktstr. 8  
32825 Blomberg  
Germany  
Tel. +49 5235 300  
Fax +49 5235 3 41200  
<http://www.phoenixcontact.com>