



Chipsmall Limited consists of a professional team with an average of over 10 year of expertise in the distribution of electronic components. Based in Hongkong, we have already established firm and mutual-benefit business relationships with customers from,Europe,America and south Asia,supplying obsolete and hard-to-find components to meet their specific needs.

With the principle of “Quality Parts,Customers Priority,Honest Operation,and Considerate Service”,our business mainly focus on the distribution of electronic components. Line cards we deal with include Microchip,ALPS,ROHM,Xilinx,Pulse,ON,Everlight and Freescale. Main products comprise IC,Modules,Potentiometer,IC Socket,Relay,Connector.Our parts cover such applications as commercial,industrial, and automotives areas.

We are looking forward to setting up business relationship with you and hope to provide you with the best service and solution. Let us make a better world for our industry!



## Contact us

Tel: +86-755-8981 8866 Fax: +86-755-8427 6832

Email & Skype: info@chipsmall.com Web: www.chipsmall.com

Address: A1208, Overseas Decoration Building, #122 Zhenhua RD., Futian, Shenzhen, China



# Series 2000 .4375" (11.1mm) Center-to-Center Spacing

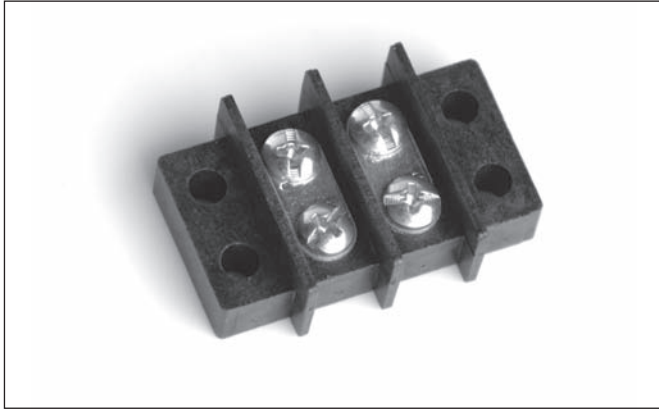

## Features:

- **Flexible Hi-Temp Thermoplastic Terminal Blocks** – Self-extinguishing types which resist breakage and other damage (conform to UL94V-0).
- **Terminal Flexibility** – Ideal for surface mount, sub-panel or chassis connections in electronic/electrical circuit applications. One thru 26 terminals.
- **Economical Closed-Back Design** – No need for costly insulation strip.
- **Broad Wire Range** – No. 6-32 external twin screws, UL recognized for No. 22AWG to No. 10AWG. Variations include double solder lug, single solder lug, wire wrap, solder pin and printed circuit pin.
- **UL/CSA Electrical Ratings** – UL 30A/1100V RMS (1/3 breakdown voltage), CSA rating: 20A/300.
- **Recognition and Listing** – Various terminal types are UL recognized and CSA certified.

## Series 2000 Variations

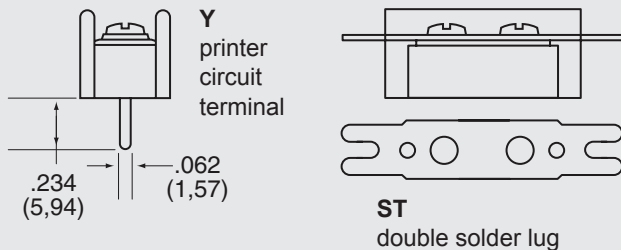
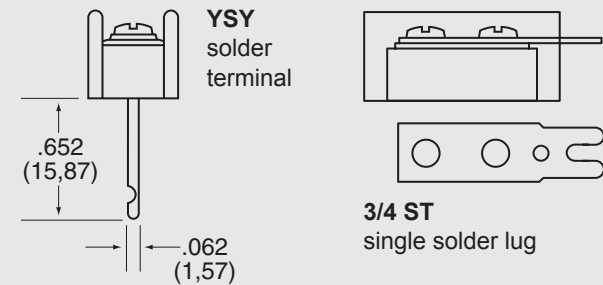
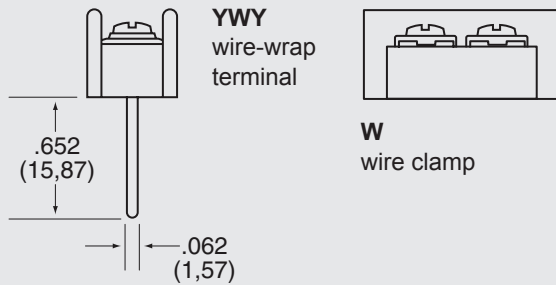

## INTERNAL TERMINAL DESIGNATIONS

- 2000-Y** printed circuit board design with .062" x .031" solderable tin-plated pin
- 2000-YSY** solder pin
- 2000-YWY** wire wrap

## EXTERNAL TERMINAL DESIGNATIONS

- 2000** screw terminal with No. 6-32 plated steel\* screw accepting up to No. 10AWG wire
- 2000-ST** solderable tin-plated double solder tab
- 2000-3/4ST** solderable tin-plated single solder tab
- 2000-W** wire clamp captivated to a No. 6-32 plated steel screw

\* Other materials available – contact factory or your local representative for additional information.

 Recognized under the Components Program of Underwriters Laboratories, Inc. Standard 1059, Guide No. XCFR2, File No. E62557.

 Guide No. 22.2 No. 158, Report No. LR39186-1. COMPLIES WITH IEC 947-7-1

## Series 2000 Dimensions

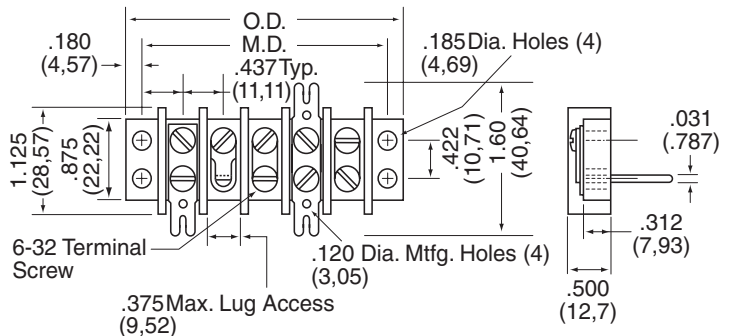

Dual Row

BARRIER STYLE





## Specifications:

**Center-to-Center Spacing:** .4375" (11.11mm)

**Wire Range:** Up to No. 10AWG (CSA requires use of lugs on wire larger than No. 16AWG.)

**No. of Terminals:** 1 thru 26

### Voltage Rating:

CSA – 300V

UL – 150V – General Industrial

250V – Commercial Appliance

300V – Limited Energy Industrial

**Tightening Torque:** Wire Clamp and Wire Binding Screw 12 in.-lbs.

**Current Rating:** UL: 30 amps CSA: 20 amps

### Housing:

Material Polyphenylene Oxide

Continuous Use

Temp. (UL Index) 110°C (230°F)

Flammability Rating 94V-0

Water Absorption

(24 hrs. % wt. gain) .06%

Chemical Resistance Resistant to inorganic bases and acids. For organic substances contact factory for specific resistance.

### Breakdown Voltage:

Terminal - Terminal 4,400V Typ.

Terminal - Ground 7,700V Typ.

*Note:* Specifications contained herein are subject to change without notice

## PC BOARD DRILLING DIMENSIONS

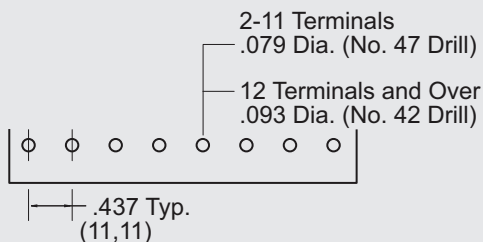

## How to Order

2000 Series terminal blocks are ordered by listing a composite number made up of the model designation in which the last two digits indicate the number of poles required for the application. Example: A 2000 10-terminal block becomes stock number 2010.

Suffixes are used as follows:

ST denotes double solder lug

3/4ST denotes single solder lug

Y denotes printed circuit pin

YSY solder pin

YWY wire wrap

W wire clamp

The 2010 described above, with double solder lug mounting on 7/16" centers thus converts to stock number 2010-ST. To specify quick-connect terminals, simply add the style number required. (See accessories.) May be purchased factory-assembled or as customer-installed accessory.

Number of Terminals	Mounting Dimensions		Overall Dimensions	
	Inches	Metric (mm)	Inches	Metric (mm)
1	.875	22.22	1.235	31.36
2	1.312	33.33	1.672	42.48
3	1.750	44.45	2.110	53.59
4	2.187	55.56	2.547	64.70
5	2.625	66.67	2.985	75.81
6	3.062	77.78	3.422	86.93
7	3.500	88.90	3.860	98.04
8	3.937	100.01	4.297	109.15
9	4.375	111.12	4.735	120.26
10	4.812	122.23	5.172	131.38
11	5.250	133.35	5.610	142.49
12	5.687	144.46	6.047	153.60
13	6.125	155.57	6.485	164.71
14	6.562	166.68	6.922	175.83
15	7.000	177.80	7.360	186.94
16	7.437	188.91	7.797	198.05
17	7.875	200.02	8.235	209.16
18	8.312	211.13	8.672	220.28
19	8.750	222.25	9.110	231.39
20	9.187	233.36	9.547	242.50
21	9.625	244.47	9.985	253.61
22	10.062	255.58	10.422	264.73
23	10.500	266.70	10.860	275.84
24	10.938	277.83	11.299	286.77
25	11.376	288.95	11.736	298.09
26	11.814	300.08	12.174	309.22

Dimensions Shown are  $\pm 0.030$ "



## Series 1500/2000 Accessories

### QUICK-CONNECT TERMINALS

1500/2000 – Available with .187" x .202" quick-connect tabs for 1500 series; .250" x .032" for 2000 series. Nine styles . . . tin-plated brass tabs held in place by terminal screws. Up to six terminations per pole. To order, specify:

1500 Series: Part No. TB11-19

2000 Series: Part No. TB31-39

Last digit of part number corresponds to previous style numbers.

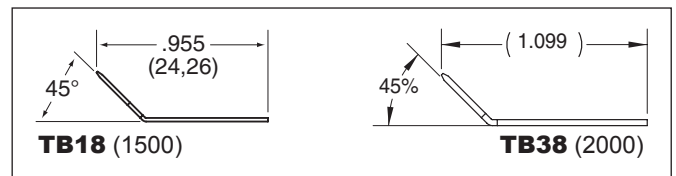
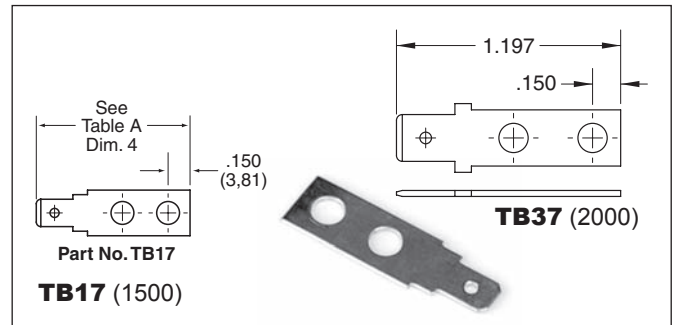
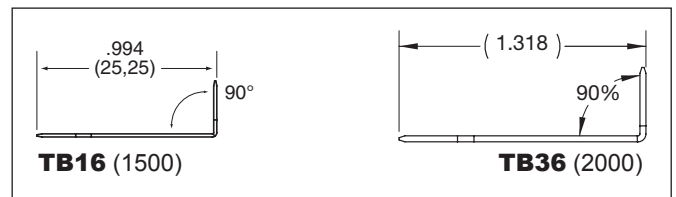
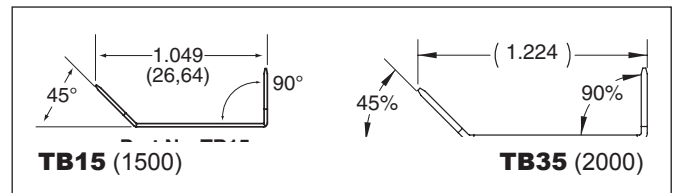
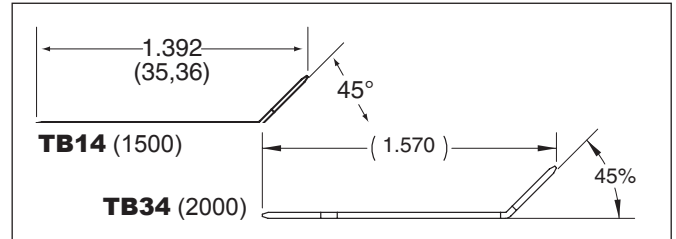
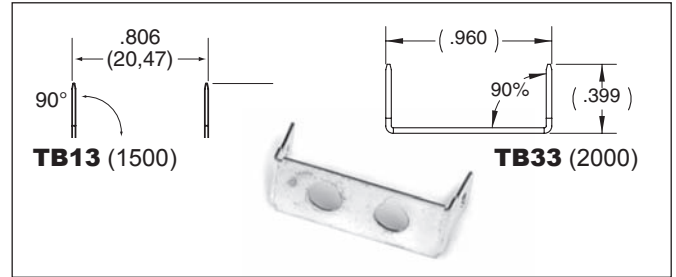
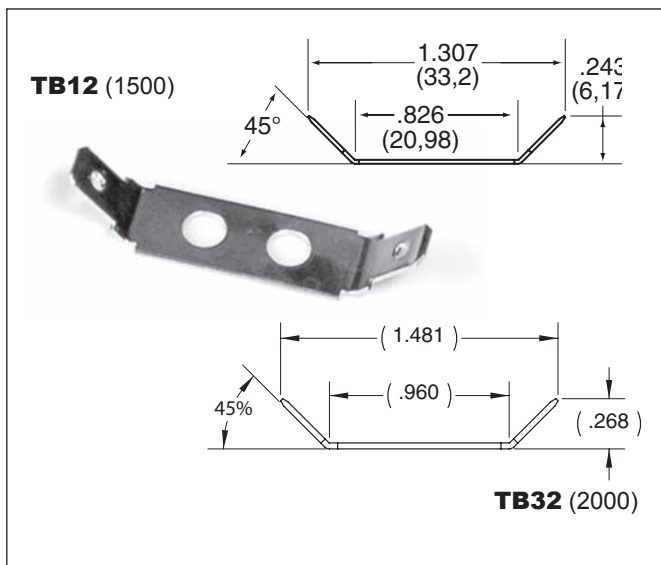
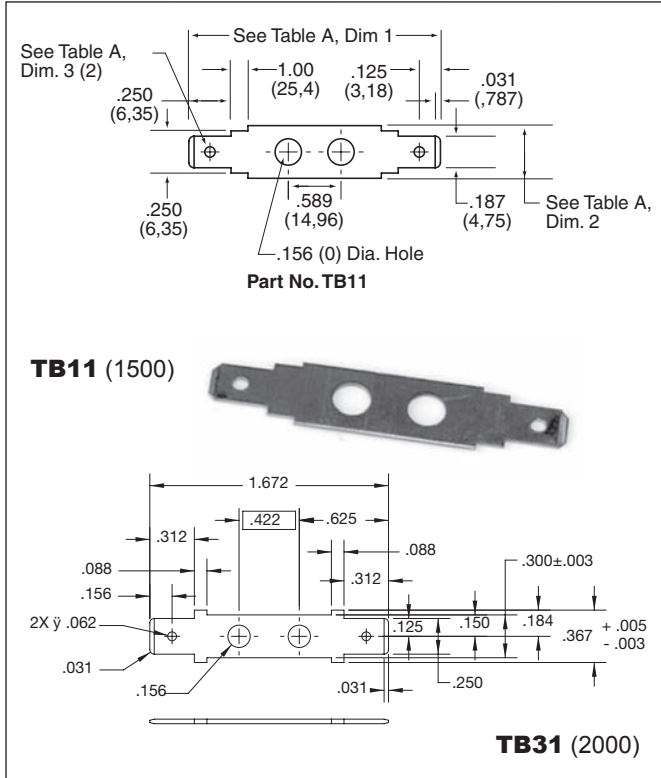

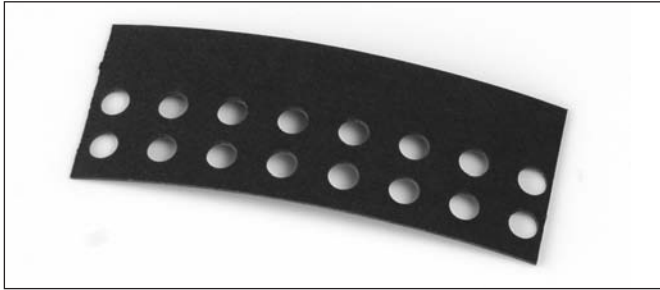

### MARKING STRIPS

1500/2000 Pre-punched black fiber . . . mounts under block.  
May be imprinted to customer specifications.

To order, specify:

1500 Series – Part No. 247A10-1 thru 22

2000 Series – Part No. 247A11-1 thru 22

### WIRE CLAMP

1500/2000 – Wire clamp captivated to No. 6-32 screw eliminates need for lugs.

1500 Series – Part No. 058525700

2000 Series – Part No. 058526700

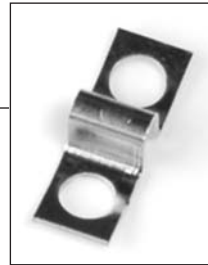
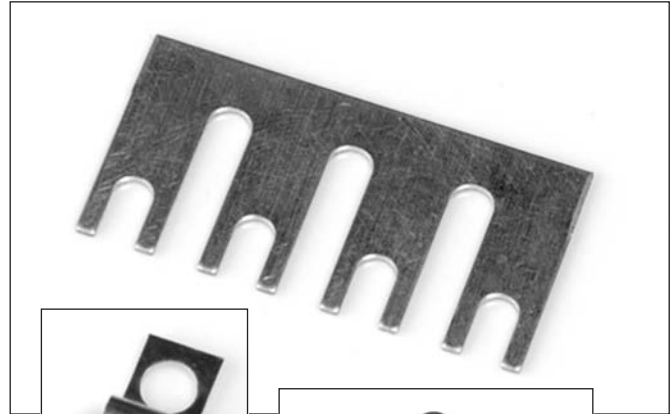
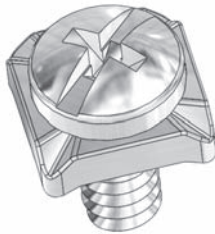

Part No.  
68240100



Part No. 68245100

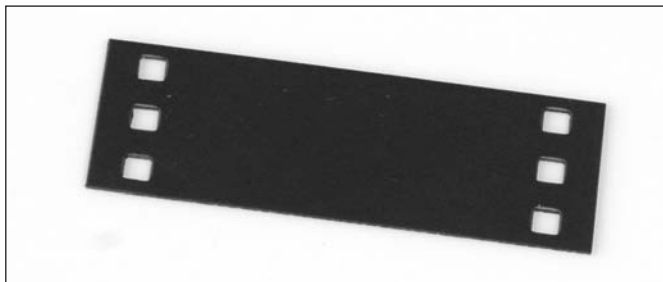

### COVERS

1500/2000 – Rigid .030" thick self-extinguishing vinyl.  
Complete with spring clips for attaching to mounting positions.

To order, specify:

1500 Series – Part No. 247B24-1 thru 26 terminals

2000 Series – Part No. 247B25-1 thru 26 terminals

### TERMINAL BLOCK JUMPERS

1500 – Jumper is constructed of plated brass. "Rooster comb" design permits connections of two to 10 poles.

To order, specify: Part No. 278-A11 (plus no. of poles)

*Example: 278A11-10*

Part No. 68240100 (Holes) or 68245100 (slots)  
(2-pole jumper for 1500 only)

2000 – Plated brass in two styles. Types 267A28 is designed to jump two adjacent terminals as it is channeled to cross over the barrier top. "Rooster comb" design of Type 267A42 permits connections of two to 18 poles.

To order, specify: Part No. 267A42 (plus no. of poles)

*Example: 267A42-18*

