



Chipsmall Limited consists of a professional team with an average of over 10 year of expertise in the distribution of electronic components. Based in Hongkong, we have already established firm and mutual-benefit business relationships with customers from,Europe,America and south Asia,supplying obsolete and hard-to-find components to meet their specific needs.

With the principle of “Quality Parts,Customers Priority,Honest Operation,and Considerate Service”,our business mainly focus on the distribution of electronic components. Line cards we deal with include Microchip,ALPS,ROHM,Xilinx,Pulse,ON,Everlight and Freescale. Main products comprise IC,Modules,Potentiometer,IC Socket,Relay,Connector.Our parts cover such applications as commercial,industrial, and automotives areas.

We are looking forward to setting up business relationship with you and hope to provide you with the best service and solution. Let us make a better world for our industry!



Contact us

Tel: +86-755-8981 8866 Fax: +86-755-8427 6832

Email & Skype: info@chipsmall.com Web: www.chipsmall.com

Address: A1208, Overseas Decoration Building, #122 Zhenhua RD., Futian, Shenzhen, China



INTEGRATED PASSIVE COMPONENTS

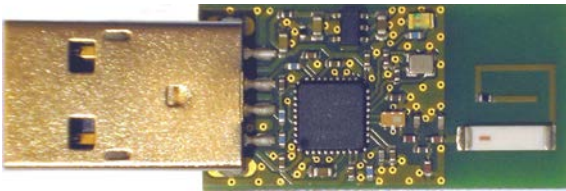
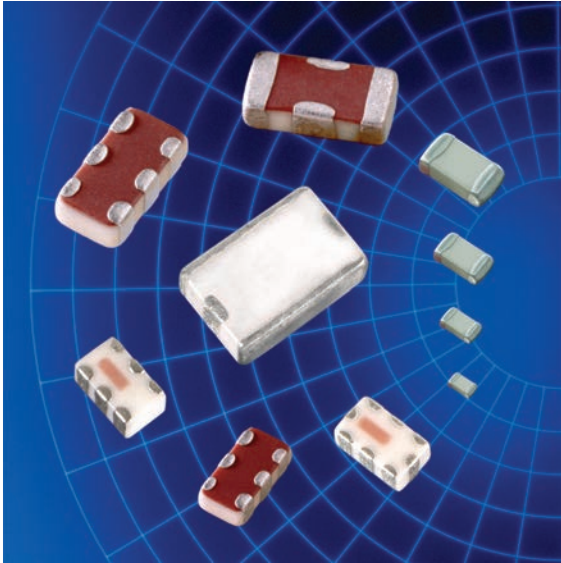

Johanson Technology has developed a line of small, highly reliable RF ceramic components manufactured with a proprietary LTCC (low temperature co-fired ceramic) process. These components operate over several bands from 900MHz to 6 GHz covering Cellular, DECT, WLAN, Bluetooth, 802.11 (a,b and g) and GPS applications.

In addition to the array of listed components we can support custom solutions for high volume applications with design flexibility and short development times. Contact us today with your specific technical requirements.

KEY FEATURES

- Custom Solutions
- LTCC Based Designs
- Low Insertion Loss
- Miniature Size / Low Profile
- Temperature Stable
- Surface Mount
- RoHS Compliant, Standard, Use No Suffix
- Tin / Lead Term. Option, Add "/Pb" Suffix

SUPPORTED APPLICATION BANDS

- Wireless LAN, Bluetooth, Home RF
- GSM/EDGE/GPRS/DCS/PCS/WCDMA
- WiMAX 802.16 d/e
- 2.4 GHz & 5.5 GHz ISM Band
- Zigbee
- MIMO
- GPS
- UNII
- UWB

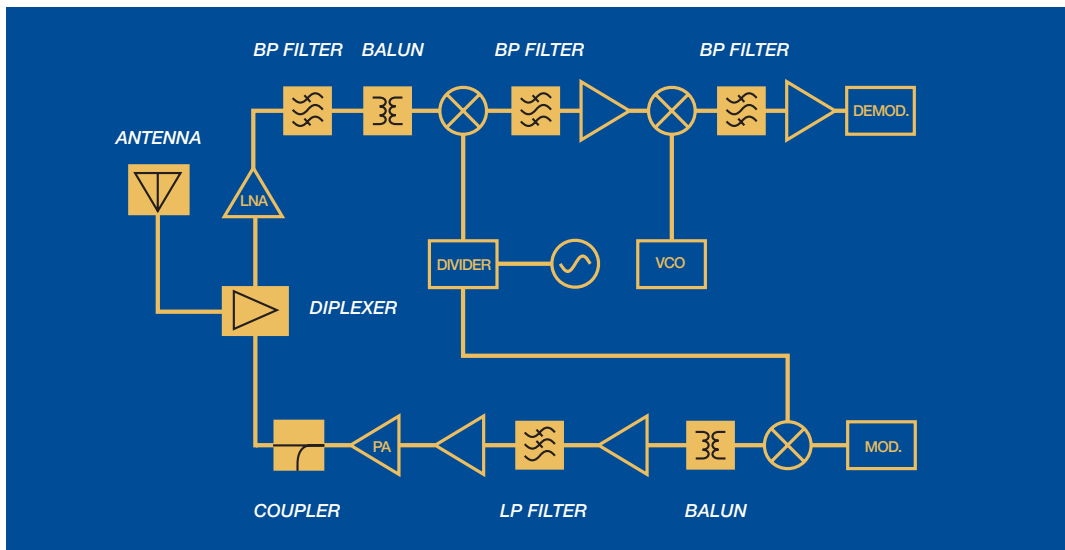

CERAMIC CHIP ANTENNAS

Part Number	Frequency (MHz)	Peak Gain	Ave. Gain	Return Loss (min)	Case Size
0433AT62A0020	423 - 443	-4 dBi typ. (XZ-total)	-4 dBi typ. (XZ-total)	9.5 dB	See Spec Sheet
0783AT43A0008	779 - 787	-2.0 dBi typ. (XZ-total)	-5.0 dBi typ. (XZ-total)	9.5 dB	43-1
0868AT43A0020	858 - 878	-1.0 dBi typ (XZ-total)	-4.0 dBi typ (XZ-total)	9.5 dB	43-1
0920AT50A080	880 - 960	-0.7 dBi typ (XZ-V)	-2.6 dBi typ (XZ-V)	8.5 dB	50
0915AT43A0042	894 - 936	-1.0 dBi typ (XZ-total)	-4.0 dBi typ (XZ-total)	8.5 dB	43-1
0915AT43A0026	902 - 928	-1.0 dBi typ (XZ-total)	-4.0 dBi typ (XZ-total)	8.5 dB	43-1
0953AT43A0006	950 - 956	-1.0 dBi typ.(XZ-total)	-1.0 dBi typ.(XZ-total)	9.5 dB	43-1
1575AM55B0001	1575.42 ± 5 MHz	1.3 dBi typ (YZ-total)	-0.7 dBi typ (YZ-total)	9.5 dB	See Spec Sheet
1575AT43A0040	1555 - 1595	- 1.5 dBi typ (XZ-V)	-2.5 dBi typ (XZ-V)	9.5 dB	43-1
1575AT47A0040_	1555 - 1595	-1.0 dBi typ (XZ-V)	-3.0 dBi typ (XZ-V)	9.5 dB	47-1
1575AT54A0010	1570 - 1580	1.3 dBi typ (YZ-Total)	-0.7 dBi typ (YZ-Total)	9.5 dB	See Spec Sheet
1600AT45A0040	1580 - 1620	0.0 dBi typ (XZ-Total)	-1.0 dBi typ (XZ-Total)	9.5 dB	45-1
2000AT18A0075	1965 - 2040	0.3 dBi typ (XZ-V)	-3 dBi typ (XZ-V)	9.5 dB	18-4
2450AT18A100	2400 - 2500	0.5 dBi typ (XZ-V)	-0.5 dBi typ (XZ-V)	9.5 dB	18-4
2450AT18A0150	2375 - 2525	0.5 dBi typ (XZ-V)	-0.5 dBi typ (XZ-V)	9.5 dB	18-4
2450AT18B100	2400 - 2500	0.5 dBi typ (XZ-V)	-0.5 dBi typ (XZ-V)	9.5 dB	18-4
2450AT18D0100	2400 - 2500	1.5 dBi typ.(XZ-V)	-1.0 dBi typ.(XZ-V)	6.0 dB	18-5
2450AT42A100	2400 - 2500	0 dBi typ (XZ-V)	-1 dBi typ (XZ-V)	9.5 dB	42-1
2450AT42B100	2400 - 2500	0 dBi typ (XZ-V)	-1.5 dBi typ (XZ-V)	9.5 dB	42-1
2450AT42D0100	2400 - 2500	0.5 dBi typ (XZ-total)	-2.0 dBi typ (XZ-V)	6.0 dB	42-1
2450AT43A100	2400 - 2500	2.0 dBi typ (XZ-V)	0.5 dBi typ (XZ-V)	9.5 dB	43-1
2450AT43B100	2400 - 2500	1.3 dBi typ (XZ-V)	-0.5 dBi typ (XZ-V)	9.5 dB	43-2
2450AT43D100	2400 - 2500	-0.5 dBi typ	-3.6 dBi typ	9.5 dB	See Spec Sheet
2450AT43F0100	2400 - 2500	2.1 dBi typ (XZ-total)	1.0 dBi typ (XZ-total)	---	See Spec Sheet
2450AT43H0100	2400 - 2500	2.1 dBi typ. (XZ-V)	1.0 dBi typ. (XZ-V)	9.5 dB	See Spec Sheet
2450AT45A100_	2400 - 2500	3.0 dBi typ (XZ-V)	1.0 dBi typ (XZ-V)	9.5 dB	45-1
2450AD46A5388	LB: 2400 - 2500 HB: 4900 - 5875	1.0 dBi typ (XZ-V) -1.5 dBi typ (YZ-V)	-2.5 dBi typ (XZ-V) -2.5 dBi typ (YZ-V)	8.5 dB 8.5 dB	See Spec Sheet
2450AD46A5400 (Dual Band)	LB: 2400 - 2500 HB: 4900 - 5900	1.0 dBi typ (XZ-V) -1.5 dBi typ (XZ-V)	-2.5 dBi typ (YZ-V) -2.5 dBi typ (YZ-V)	8.5 dB 8.5 dB	46-1
2500AT43A0100	2450 - 2550	0.6 dBi typ (YZ-total)	-2.1 dBi typ (XZ-total)	3.0 dB	43-1
2500AT44M0400	2300 - 2700	2.5 dBi typ	0.5 dBi typ	9.5 dB	44-2
2500AT52M3555 WiMax (Tri-Band)	2300 - 2690 3300 - 3900 5150 - 5875	2.0 dBi typ 2.0 dBi typ 2.0 dBi typ	-2.0 dBi typ -4.0 dBi typ -3.0 dBi typ	8.5 dB 9.5 dB 9.5 dB	See Spec Sheet
2600AT44A0600	2300 - 2900	2.0 dBi	0.0 dBi typ.	9.5 dB	42-2
2650AT43A0100	2600 - 2700	0.5 dBi typ (YZ-total)	-1.7 dBi typ (XZ-total)	3.0 dB	50
3100AT51A7200	3100 - 10300	1.5 dBi typ	-3.5 dBi typ	9.5 dB	51-1
4000AT44A1800	3100 - 4900	2.7 dBi typ	-3.5 dBi typ	7.4 dB	See Spec Sheet
5250AT43A200_	5150 - 5350	3.6 dBi typ (XZ-V)	-2.3 dBi typ (XZ-V)	9.5 dB	43-1
5400AT18A1000	4900 - 5900	2.0 dBi typ (XZ-V)	-2.5 dBi typ (XZ-V)	8.5 dB	18-4
5500AT18A0725	5150 - 5875	2.0 dBi typ. (XZ-V)	-2.5 dBi typ. (XZ-V)	9.5 dB	18-4
5775AT43A100_	5725 - 5825	3.9 dBi typ (XZ-V)	-1.5 dBi typ (XZ-V)	9.5 dB	43-1

Basic case size drawings for above part numbers are located on pages 39-40.

Detailed specifications and performance curves for the RF Ceramic Component line are located on our website.

ANTENNA MODULES

Part Number	Center Freq. (MHz)	Peak Gain	Ave. Gain	Return Loss (min)	Case Size
1575AM55B0001	1575.42 ± 5 MHz	1.3 dBi typ. (YZ-total)	-0.7 dBi typ. (YZ-total)	9.5 dB	See Spec Sheet

BAND-PASS FILTERS: 2.45 GHZ

Part Number	Frequency (MHz)	Insertion Loss (max.)	Attenuation (min)	Return Loss (min)	Case Size
2450BP07A0100	2400 - 2500	2.5 dB	25 dB @ 824 - 960 MHz 25 dB @ 1710 - 1910 MHz 25 dB @ 4800 - 5000 MHz 15 dB @ 7200 - 7500 MHz	9.5 dB	07-1
2450BP14D0100	2400 - 2500	1.7 dB	30 dB @ 880 - 915 MHz 30 dB @ 1710 - 1785 MHz 25 dB @ 1850 - 1910 MHz 25 dB @ 4800 - 5000 MHz 15 dB @ 7200 - 7500 MHz	9.5 dB	14-1
2450BP14E0100	2400 - 2500	2.5 dB	35 dB @ 824 - 960 MHz 38 dB @ 1710 - 1910 MHz 25 dB @ 4800 - 5000 MHz 20 dB @ 7200 - 7500 MHz	9.5 dB	14-1
2450BP15B100	2400 - 2500	2.2 dB	25 @ 1200 - 1300 MHz 10 @ 2000 MHz 12 @ 3000 MHz 30 @ 3600 - 3800 MHz 34 @ 4800 - 5000 MHz	9.5 dB	15-3A
2450BP15C100	2400 - 2500	2.2 dB	30 dB @ 1200 - 1300 MHz 15 dB @ 2000 MHz 25 dB @ 3000 MHz 20 dB @ 3600 - 3800 MHz 20 dB @ 4800 - 5000 MHz	9.5 dB	15-3B
2450BP15D100	2400 - 2500	2.6 dB	30 dB @ 880 - 1990 MHz 20 dB @ 2110 - 2170 MHz 30 dB @ 4800 - 5000 MHz 20 dB @ 7200 - 7500 MHz	9.5 dB	15-1F
2450BP15E0100	2400 - 2500	1.5 dB	30 dB @ 880 - 915 MHz 30 dB @ 1710 - 1785 MHz 25 dB @ 1850 - 1910 MHz 25 dB @ 4800 - 5000 MHz 15 dB @ 7200 - 7500 MHz	9.5 dB	15-3C
2450BP15F0100	2400 - 2500	2.5 dB	35 dB @ 824 - 960 MHz 38 dB @ 1710 - 1910 MHz 25 dB @ 4800 - 5000 MHz 20 dB @ 7200 - 7500 MHz	9.5 dB	15-1G
2450BP15G0100	2400 - 2500	2.0 dB	30 dB @ 824 - 960 MHz 28 dB @ 1710 - 1910 MHz 20 dB @ 1910 - 1990 MHz 30 dB @ 4800 - 5000 MHz 20 dB @ 7200 - 7500 MHz	9.5 dB	15-1G
2450BP15H0100	2400 - 2500	1.5 max. @ 25°C 1.8 max. @ -40 - 85°C	25 dB @ 1200 - 1300 MHz 10 dB @ 2000 MHz 12 dB @ 3000 MHz 30 dB @ 3600 - 3800 MHz 34 dB @ 4800 - 5000 MHz	9.5 dB	15-3C

Basic case size drawings for above part numbers are located on pages 39-40.

Detailed specifications and performance curves for the RF Ceramic Component line are located on our website.

BAND-PASS FILTERS: 2.45 GHZ

Part Number	Frequency (MHz)	Insertion Loss (max.)	Attenuation (min)	Return Loss (min)	Case Size
2450BP18C100E	2400 - 2500	2.5 dB	40 dB @ 1200 - 1800 MHz 25 dB @ 2100 MHz 35 dB @ 4800 - 5000 MHz 25 dB @ 7200 - 7500 MHz	9.5 dB	18-1
2450BP39C100A	2400 - 2500	2.5 dB	42 dB @ 1710 - 1990 MHz 30 dB @ 2100 MHz 30 dB @ 4800 - 5000 MHz	9.5 dB	39-1B
2450BP39C100B	2400 - 2500	1.8 dB	30 dB @ 1710 - 1780 MHz 25 dB @ 1850 - 1910 MHz 25 dB @ 4800 - 5000 MHz	9.5 dB	39-1B
2450BP39C100C	2400 - 2500	1.5 dB	30 dB @ 800 - 915 MHz 30 dB @ 1710 - 1785 MHz 25 dB @ 1850 - 1910 MHz 25 dB @ 4800 - 5000 MHz 15 dB @ 7200 - 7500 MHz	9.5 dB	39-1B
2450BP39C100D	2450 ± 50	2.2 dB	30 dB @ 880 - 915MHz 30 dB @ 1710 - 1785MHz 25 dB @ 1850 - 1910MHz 25 dB @ 2100MHz 25 dB @ 4800 - 5000MHz 15 dB @ 7200 - 7500MHz	9.5 dB	39-1D
2450BP39D100B	2400 - 2500	2.5 dB	35 dB @ 880 - 915 MHz 18 dB @ 1710 - 1990 MHz 12 dB @ 2100 MHz 35 dB @ 3200 MHz 22 dB @ 4800 - 5000 MHz 22 dB @ 7200 - 7500 MHz	9.5 dB	39-1B
2450BP39D100C	2400 - 2500	1.2 dB	30 dB @ 880 - 915 MHz 30 dB @ 1710 - 1785 MHz 25 dB @ 1850 - 1910 MHz 25 dB @ 4800 - 5000 MHz 15 dB @ 7200 - 7500 MHz	9.5 dB	39-1B

Basic case size drawings for above part numbers are located on pages 39-40.

Detailed specifications and performance curves for the RF Ceramic Component line are located on our website.

BAND-PASS FILTERS: 2.45 GHz

Part Number	Frequency (MHz)	Insertion Loss (max.)	Attenuation (min)	Return Loss (min)	Case Size
2450BP39D100E	2400 - 2500	1.2 dB	30 @ 880 - 915 MHz 30 @ 1710 - 1785 MHz 25 @ 1850 - 1910 MHz 2 @ 2700 MHz 25 @ 4800 - 5000 MHz 15 @ 7200 - 7500 MHz	9.5 dB	39-1
2450BP39F100A	2400 - 2500	2.4 dB	45 dB @ 880 - 915 MHz 48 dB @ 1710 - 1990 MHz 20 dB @ 2110 - 2170 MHz 30 dB @ 4800 - 5000 MHz 36 dB @ 7200 - 7500 MHz	9.5 dB	39-1B
2450BP41D100A	2400 - 2500	2.3 dB	40 dB @ 1200 - 1800 GHz 30 dB @ 2100 GHz 12 dB @ 2200 GHz 35 dB @ 4800 - 5000 GHz	9.5 dB	See Spec Sheet
2450BP41D100B	2400 - 2500	1.3 dB	30 dB @ 880 - 915 MHz 30 dB @ 1710 - 1785 MHz 20 dB @ 1850 - 1910 MHz 25 dB @ 4800 - 5000 MHz 20 dB @ 7200 - 7500 MHz	9.5 dB	See Spec Sheet
2450LP15B050	2400 - 2500	0.5 dB	32 dB @ 2 x fo 30 dB @ 3 x fo 30 dB @ 4 x fo	10.9 dB	See Spec Sheet
2500BP15M400	2300 - 2700	2.0 dB	15 dB @ 100 - 1800 MHz 20 dB @ 3400 - 11700 MHz	9.5 dB	39-1

BAND-PASS FILTERS: 5.5 GHz

Part Number	Frequency (MHz)	Insertion Loss (max.)	Attenuation (min)	Return Loss (min)	Case Size
5400BP39A0100	4900 - 5900	3.5 dB	24 dB @ 3800 - 4500 MHz 20 dB @ 6300 - 7100 MHz	8.5 dB	See Spec Sheet
5515BP15B975	4900 - 5875	1.5 dB	30 dB @ 3500 MHz	9.5 dB	15-3B
5515BP15C725	5150 - 5875	2.0 dB	30 dB @ 500 - 4000 MHz 20 dB @ 4600 MHz 15 dB @ 10300 - 11800 MHz	9.5 dB	15-3
5515BP15C975	4900 - 5875	1.8 dB	30 dB @ 500 - 4000MHz 20 dB @ 4200MHz 15 dB @ 9800 - 11750MHz	8.5 dB	15-3B
5515BP15C1020	4900 - 5920	1.5 dB	30 dB @ 3500 MHz	9.5 dB	15-3B

Basic case size drawings for above part numbers are located on pages 39-40.

Detailed specifications and performance curves for the RF Ceramic Component line are located on our website.

BAND-PASS FILTERS: OTHER

Part Number	Frequency (MHz)	Insertion Loss (max)	Attenuation (min)	Return Loss (min)	Case Size
1200BP44A575	950 - 1525	2.8 dB	25 dB @ 100 - 480 MHz 25 dB @ 1900 - 3050 MHz	7.0 dB	44-1
1810BP07B200	1700 - 1900	1.8 dB	20 dB @ 855-955 (Prelim.) 10 dB @ 2565-2865 (Prelim.)	TBD	07-1
1906BP18A027	1893 - 1920	1.5 dB	38 dB @ 1405 - 1440 MHz 10 dB @ 1649 - 1680 MHz 24 dB @ 3786 - 3840 MHz 20 dB @ 5679 - 5760 MHz	9.5 dB	18-1
1906BP18C027	1893 - 1920	3.0 dB	40 dB @ 1427 - 1454 MHz 35 dB @ 1660 - 1687 MHz 15 dB @ 2126 - 2153 MHz	9.5 dB	See Spec Sheet
1906BP39B027	1893 - 1920	2.8 dB	40 dB @ 1660 MHz 12 dB @ 2139 MHz	9.5 dB	See Spec Sheet
2593BP44B186	2500 - 2686	2.0 dB	40 dB @ 1870 - 2056 MHz	9.5 dB	44-1
2598BP39A0205	2495 - 2700	3.0 dB	12 dB @ 2039 - 2244 MHz 24 dB @ 2951 - 3156 MHz 12 dB @ 4990 - 5400 MHz	9.5 dB	See Spec Sheet
2600BP14M0200	2500 - 2700	2.2 dB max @ 25°C 2.5 dB max @ -40 - 85°C	30 dB @ 806 - 915MHz 30 dB @ 1710 - 1785MHz 30 dB @ 1850 - 1910MHz 30 dB @ 1920 - 1980MHz 13 dB @ 3300 - 3900MHz 20 dB @ 4900 - 5900MHz	9.5 dB	See Spec Sheet
3480BP39A0140	3410 - 3550	4.0 dB	30 dB @ < 2540 MHz 14 dB @ 4020 MHz 34 dB @ 5150 - 5350 MHz	10 dB	See Spec Sheet
3600BP14M0600	3300 - 3700	1.8 dB max @ 25°C 2.0 dB max @ -40 - 85°C	30 dB @ 806 - 915MHz 30 dB @ 1710 - 1785MHz 30 dB @ 1850 - 1910MHz 30 dB @ 1920 - 1980MHz 31 dB @ 2400 - 2500MHz 18 dB @ 4900 - 5900MHz	12 dB	See Spec Sheet
3600BP15M600	3300 - 3900	1.8 dB	15 dB @ 100 - 2600 MHz 9 dB @ 4400 MHz 20 dB @ 6000 - 9900 MHz	9.5 dB	15-3B
3960BP39A1584	3168 - 4752	2.5 dB	30 dB @ 2400 - 2500 MHz 12 dB @ 5150 MHz 25 dB @ 5950 MHz	9.5 dB	See Spec Sheet
4000BP15U1800	3100 - 4900	2.0 dB	25 dB @ 1.75 GHz 13 dB @ 2.10 GHz	8.5 dB	15-2B
4000NF39A6550	3200 - 4800	3.0 dB	14 dB @ 5150 - 5350 MHz	7.0 dB	See Spec Sheet
4020BP39A0160	3940 - 4100	4.0 dB	34 dB @ < 2540 MHz 14 dB @ 3480 MHz 14 dB @ 4560 MHz 34 dB @ 5150 - 5350 MHz	20.8 dB	See Spec Sheet
4560BP39A0180	4470 - 4650	2.97 dB	48.3 dB @ < 2540 MHz 19.1 dB @ 4020 MHz 19 dB @ 5150 - 5350 MHz 35.9 dB @ 5725 - 7000 MHz	17.5 dB	See Spec Sheet

Basic case size drawings for above part numbers are located on pages 39-40.

Detailed specifications and performance curves for the RF Ceramic Component line are located on our website.

HIGH-PASS FILTERS

Part Number	Frequency (MHz)	Insertion Loss (max)	Attenuation (min)	Return Loss (min)	Case Size
1900HP41B500	1650 - 2150	2.0 dB (Prelim)	27 dB @ 950 - 1450 MHz (Prelim)	8.5 dB	41-1
1900HP41C0500	1650 - 2150	2.0 dB	27 dB @ 950 - 1450 MHz	8.5 dB	41-1
2450HP14A100	2400 - 2500	1.0 dB	9 dB @ 824 - 960 MHz 20 dB @ 1917 MHz	9.5 dB	14-1B
2450HP15A100	2400 - 2500	0.85 dB	25 dB @ 875 - 920 MHz 20 dB @ 1705 - 1790 MHz 19 dB @ 1845 - 1915 MHz	9.5 dB	See Spec Sheet
3550HP15A0500	3300 - 3800	0.6 dB max. @ 25°C 0.8 dB max. @ -40-85°C	40 dB @ 1710-1910 MHz	9.5 dB	See Spec Sheet
5200HP15A4200	3100 - 7300	2.5 dB	30 dB @ < 2540 MHz 12 dB @ 2800 MHz	9.5 dB	See Spec Sheet

NOTCH FILTER

Part Number	Frequency Range (max)	Insertion Loss (max)	Attenuation (min)	Return Loss (min)	Case Size
4000NF39A6550	3.0 dB @ 3200-4800 MHz	3.0 @ 5900-7200 MHz	30 dB @ 950 - 1450 MHz	8.5 dB	41-1

EMI FILTER

Part Number	No. of Sections	Cutoff Freq (MHz)	Attenuation (min)	Case Size
0400FA15A0400	4	400	20 dB @ 800 - 1000 MHz	See Spec Sheet

JOHANSON-TEXAS INSTRUMENTS REFERENCE DESIGN - CC2530

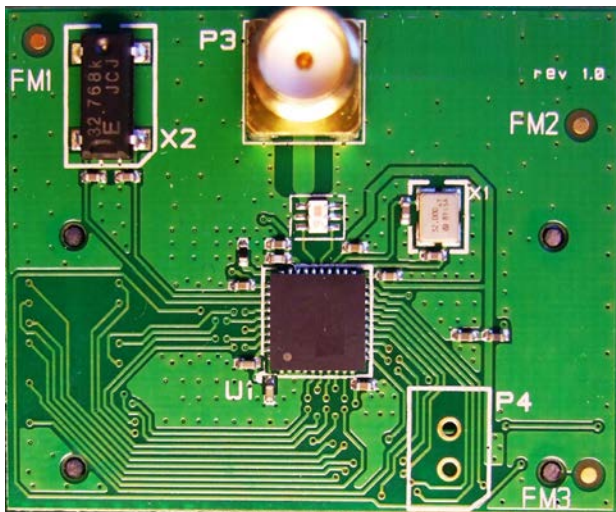

T.I. CC2530 Reference Design using Johanson

Complete passive component integration for RF Chipsets layout and design.

Johanson matched-impedance balun-filter integrated passive with TI CC2530 RF chipset.

Note: Only one component between chip and antenna SMA

Johanson p/n: 2450BM15A0002

Basic case size drawings for above part numbers are located on pages 39-40.

Detailed specifications and performance curves for the RF Ceramic Component line are located on our website.

LOW-PASS FILTERS

Part Number	Frequency (MHz)	Insertion Loss (max)	Attenuation (min)	Return Loss (min)	Case Size
0500LP15A500	0 - 500	0.7 dB	9 dB @ 824 - 960 MHz 25 dB @ 1710 - 1990 MHz 25 dB @ 2400 - 4000 MHz	9.5 dB	See Spec Sheet
0868LP15A020	858 - 878	0.5 dB	30 dB @ 2 x Fo 40 dB @ 3 x Fo	14.0 dB	15-1
0869LD14C1810	824 - 915 1710 - 1910	0.6 dB 0.6 dB	25 dB @ 2 x Fo - 18 dB @ 3 x Fo 22 dB @ 2 x Fo - 20 dB @ 3 x Fo	9.5 dB	14-1
0869LD14D1810	824 - 915 1710 - 1910	0.6 dB 0.6 dB	25 dB @ 1648-1830 - 25 dB @ 3420-3820 25 dB @ 2472 - 2745 - 25 dB @ 5130-5730	14 dB	14-1
0869LP14A090	824 - 915	0.6 dB	20 dB @ 2x Fo 15 dB @ 3x Fo	10.9 dB	14-1A
0892LP07A136	824 - 960	0.7 dB	18 dB @ 1648 - 1920 MHz 25 dB @ 2472 - 2880 MHz 25 dB @ 3296 - 3840 MHz	9.5 dB	See Spec Sheet
0898LP18A035	880 - 915	0.6 dB	30 dB @ 2x Fo 18 dB @ 3x Fo	10.9 dB	18-2
0915LP15A026	902 - 928	0.65 dB	25 dB @ 2x Fo 25 dB @ 3x Fo	9.5 dB	15-2
0915LP15B026	902 - 928	0.5 dB	30 dB @ 2x Fo 30 dB @ 3x Fo	14.0 dB	15-2A
1175LP15A0550	900 - 1450	2.5 dB	25 dB @ 1650 - 2200 MHz	9.5 dB	15-2
1200LP41B0500	950 - 1450	2.0 dB	24 dB @ 1650-2150 (+25°C)	8.5 dB	See Spec Sheet
1200LP41C0500	950 - 1450	2.0 dB	24 dB @ 1650-2150 (+25°C)	8.5 dB	See Spec Sheet
1748LP18A075	1710 - 1785	0.6 dB	30 dB @ 3500 MHz 20 dB @ 5240 MHz	10.9 dB	18-2
1810LP07A200	1710 - 1910	0.5 dB	20 dB @ 2x Fo 20 dB @ 3x Fo	10.9 dB	07-1
1810LP07B200	1710 - 1910	0.6 dB	26 dB @ 3420 - 3570 MHz 21 dB @ 3700 - 3820 MHz 21 dB @ 5130 - 5730 MHz	9.5 dB	07-1
1810LP14A200	1710 - 1910	0.6 dB	30 dB @ 3420 - 3570 MHz 25 dB @ 3700 - 3820 MHz 20 dB @ 5130 - 5730 MHz	11.7 dB	14-1A
1880LP14A060	1850 - 1910	0.6 dB	27 dB @ 2x Fo 19 dB @ 3x Fo	11.7 dB	14-1A
2400LP18A0200	2300 - 2500	0.6 dB	27 dB @ 2 x Fo 18 dB @ 3 x Fo	10.9 dB	See Spec Sheet
2450LP07A0100	2400 - 2500	0.45 dB max @ 25°C 0.55 dB max @ -40-85°C	21 dB @ 4800 - 5000 MHz 21 dB @ 7200 - 7500 MHz	11.7 dB	07-1
2450LP14A100	2400 - 2500	0.5 dB	25 dB @ 2x Fo 18 dB @ 3x Fo	14.0 dB	14-1A
2450LP14B100	2400 - 2500	0.5 dB	35 dB @ 2x Fo 25 dB @ 3x Fo	14.0 dB	14-1A

Basic case size drawings for above part numbers are located on pages 39-40.

Detailed specifications and performance curves for the RF Ceramic Component line are located on our website.



LOW-PASS FILTERS

Part Number	Frequency (MHz)	Insertion Loss (max)	Attenuation (min)	Return Loss (min)	Case Size
2450LP15A050	2400 - 2500	0.5 dB	27 dB @ 2x _{Fo} 25 dB @ 3x _{Fo}	10.9 dB	15-2
2450LP15B050	2400 - 2500	0.5 dB	32 dB @ 2 x _{Fo} 30 dB @ 3 x _{Fo} 30 dB @ 4 x _{Fo}	10.9 dB	15-2
2500LP14A0400	2300 - 2700	0.55 dB	35 dB @ 2 x _{Fo} 25 dB @ 3 x _{Fo}	11.7 dB	14-1
2500LP14B0400	2300 - 2700	0.62 dB	27 dB @ 2 x _{Fo} 25 dB @ 3 x _{Fo}	14.0 dB	14-1
3550LP14A300	3400 - 3700	0.65 dB	25 dB @ 3x _{Fo}	14.0 dB	14-1
5515LP15A730	5150 - 5875	0.5 dB	25 dB @ 2x _{Fo} 18 dB @ 3x _{Fo}	10.9 dB	15-2

DUAL LOW PASS FILTER

Part Number	Frequency (MHz)	Insertion Loss (max)	Attenuation (min)		Return Loss (min)	Case Size
			2x _{Fo}	3x _{Fo}		
0869LD14C1810	824 - 915 1710 - 1910	0.6 dB 0.6 dB	25 dB 22 dB	18 dB 20 dB	9.5 dB	14-1

DIRECTIONAL COUPLERS

Part Number	Frequency (MHz)	Insertion Loss (max)	Return Loss (min)	Coupling (dB)	Isolation (min.)	Case Size
0450CP14A0040	430 - 470	0.2 dB	20.8 dB	27.5 ± 2.0 dB	45.0 dB	14-1
0848CP14A075	810 - 885	0.25 dB	15.6 dB	20.3 ± 1.0 dB	28.0 dB	14-1
0869CP14A090	824 - 915	0.3 dB	15.6 dB	17 ± 1.0 dB	26.0 dB	14-1
0898CP14A035	880 - 915	0.28 dB	15.6 dB	18 ± 1.0 dB	26.0 dB	14-1
0898CP14B035	880 - 915	0.25 dB	15.6 dB	20 ± 1.0 dB	28.0 dB	14-1
0898CP15A035	880 - 915	0.50 dB	14.0 dB	20 ± 1.0 dB	25.0 dB	15-1
0967CP14A024	955 - 979	0.50 dB	15.6 dB	12.5 ± 1.0 dB	19.0 dB	14-1
1575CH15A0030	1560 - 1590	3.3 ± 0.5 dB max.	10.0 dB		16.0 dB	15-1
1747CP14A075	1710 - 1785	0.44 dB	15.6 dB	14.5 ± 1.0 dB	25.0 dB	14-1
1748CP15A075	1710 - 1785	0.50 dB	14.0 dB	20 ± 1.0 dB	25.0 dB	15-1
1810CP14A200	1710 - 1910	0.30 dB	15.6 dB	20 ± 1.0 dB	25.0 dB	14-1
2450CP14A100	2400 - 2500	0.74 dB	TBD dB	10 ± 1.0 dB	22.0 dB	14-1
2450CP14B100	2400 - 2500	0.34 dB	TBD dB	17.65 ± 1.0 dB	25.0 dB	14-1
2600CF15A0200	2500 - 2700	1.0 dB	16.0 dB	20 ± 1.0 dB	29.0 dB	15-1

Basic case size drawings for above part numbers are located on pages 39-40.

Detailed specifications and performance curves for the RF Ceramic Component line are located on our website.

DIRECTIONAL COUPLER - DUAL BAND, SINGLE PATH

Part Number	Frequency (MHz)	Insertion Loss (max)	Return Loss (min)	Coupling (dB)	Isolation (min.)	Case Size
0869CP14B1050	B1) 824 - 915 B2) 999 - 1102	0.4 dB 0.6 dB	15.5 dB 15.5 dB	14.2 ± 1.0 12.7 ± 1.0	23.0 dB 22.0 dB	14-1
0869CD14B1810	B1) 824 - 915 B2) 1710 - 1910	0.4 dB 0.4 dB	14.0 dB 14.0 dB	19.5 ± 1.0 19.5 ± 1.0	30.0 dB 30.0 dB	14-1

DIRECTIONAL COUPLER - DUAL BAND, DUAL PATH

Part Number	Frequency (MHz)	Insertion Loss (max)	Return Loss (min)	Coupling (dB)	Isolation (min.)	Case Size
0869CD14A1810	B1) 824 - 915 B2) 1710 - 1910	0.40 dB 0.40 dB	-	19.5 ± 1.0 19.5 ± 1.0	B1 In > Term: 30.0 dB B2 In > Term: 30.0 dB	14-1
0898CD15B1748	B1) 880 - 915 B2) 1710 - 1785	0.40 dB 0.40 dB	10.9 dB 10.9 dB	19.2 ± 1.0 19.2 ± 1.0	B1 In > B2 Out: 35.0 dB B1 In > B2 In: 25.0 dB B1 Out > B2 In: 25.0 dB B1 In > Term: 23.0 dB B2 In > Term: 23.0 dB	15-2
0898CD15C1748	B1) 880-915 B2) 1710-1785	0.35 dB 0.45 dB	10.9 dB 10.9 dB	19.2 ± 1.0 14.0 ± 1.5	B1 In > B2 Out: 35.0 dB B1 In > B2 In: 24.0 dB B1 Out > B2 In: 24.0 dB B1 In > Term: 24.0 dB B2 In > Term: 24.0 dB	15-2
0898CD15D1748	B1) 1710-1785 B2) 880-915	0.50 dB 0.35 dB	14.0 dB 14.0 dB	14.0 ± 1.5 19.2 ± 1.0	B1 In > B2 Out: 25.5 dB B1 In > B2 In: 21.0 dB B1 Out > B2 In: 22.0 dB B1 In > Term: 17.0 dB B2 In > Term: 24.0 dB	15-2

DIRECTIONAL COUPLER WITH LOW PASS FILTER

Part Number	Frequency (MHz)	Insertion Loss (max)	Return Loss (min)	Coupling (dB)	Isolation (min.)	Attenuation (min.)		Case Size
						2 x Fo	3 x Fo	
0898CF15A035_	880 - 915	0.7 dB	14 dB	20 ± 1.0	25.0 dB	22.0 dB	17.0 dB	15-1
0910CF15B0100	860 - 960	1.2 dB	20 dB	10 ± 1.0	30.0 dB	27 dB @ 2 x Fo 30 dB @ 3 x Fo 30 dB @ 4 x Fo 30 dB @ 5 x Fo		See Spec Sheet
1748CF15A075_	1710 - 1785	0.5 dB	14 dB	20 ± 1.0	25.0 dB	22.0 dB		15-1
2450CF15A0100	2400 - 2500	0.8 dB	20 dB	15 ± 1.0	22.0 dB	20.0 dB		15-1
5300CF15A0950	4900 - 5850	0.8 dB	20 dB	15 ± 1.0	22.0 dB	20.0 dB		15-1

Basic case size drawings for above part numbers are located on pages 39-40.

Detailed specifications and performance curves for the RF Ceramic Component line are located on our website.

DIRECTIONAL COUPLER - SPLITTER, 3 dB HYBRID

Part Number	Frequency (MHz)	Insertion Loss (max)	Return Loss (min)	Isolation (min.)	Case Size
0880CH15A060	850 - 910	3.3 ± 0.5 dB	14.0 dB	20.0 dB	15-4
1472CH15A050	1452 - 1492	3.3 ± 0.5 dB	14.0 dB	16.0 dB	15-4
1950CH15A100	1900 - 2000	3.3 ± 0.5 dB	14.0 dB	16.0 dB	15-4
2450CH15A0100	2400 - 2500	3.3 ± 0.5 dB	14.0 dB	15.0 dB	15-4

CERAMIC CHIP BALUNS

Part Number	Frequency (MHz)	Impedance Unbal./Bal.	Insertion Loss (max)	Return Loss (min)	Phase Difference	Amplitude Difference (max)	Case Size
0430BL15A0100	400 - 460	50/100	1.0 dB	9.5 dB	180°±10°	2.0 dB	15-1
0465BL15B100	460 - 470	50/100	1.0 dB	9.5 dB	180°±10°	1.5 dB	15-1A
0896BL14B050	851 - 941	50/50	1.5 dB	9.5 dB	180°±10°	0.7 dB	14-1A
0866BL15C200	800 - 900	50/200	1.2 dB	9.5 dB	180°±10°	1.0 dB	15-1E
0900BL15C050	800 - 1000	50/50	1.2 dB	9.5 dB	180°±10°	2.0 dB	15-1D
0900BL18B100	800 - 1000	50/100	1.0 dB	9.5 dB	180°±10°	2.0 dB	18-1
0900BL18B200	800 - 1000	50/200	1.0 dB	9.5 dB	180°±10°	2.0 dB	18-1
0900BL15A100	900 - 1000	50/100	1.2 dB	9.5 dB	180°±10°	2.0 dB	15-1
0917BL18B100	889 - 945	50/100	1.0 dB	9.5 dB	180°±10°	2.0 dB	18-1
1450BL15A200	1400 - 1500	50/200	1.0 dB	9.5 dB	180°±10°	2.0 dB	15-1C
1472BL15B0100	1452 - 1492	50/100	1.0 dB	9.5 dB	180°±10°	2.0 dB	15-1A
1600BL15B050	1500 - 1700	50/50	1.0 dB	9.5 dB	180°±10°	2.0 dB	15-1B
1600BL15B100	1500 - 1700	50/100	1.0 dB	9.5 dB	180°±10°	2.0 dB	15-1B
1800BL18B200	1700 - 1900	50/200	0.8 dB	9.5 dB	180°±10°	2.0 dB	18-1
1850BL15B050	1700 - 2000	50/50	1.0 dB	9.5 dB	180°±10°	2.0 dB	15-1B
1850BL15B100	1700 - 2000	50/100	1.0 dB	9.5 dB	180°±10°	2.0 dB	15-1B
1850BL15B200	1700 - 2000	50/200	1.0 dB	9.5 dB	180°±10°	2.0 dB	15-1B
2100BL18B200	2000 - 2200	50/200	0.8 dB	9.5 dB	180°±10°	2.0 dB	18-1
2100BL15A100	2100 - 2200	50/100	1.0 dB	9.5 dB	180°±10°	2.0 dB	15-1
2450BL07A0100	2400 - 2500	50/100	1.3 dB	9.5 dB	180°±10°	2.0 dB	See Spec Sheet
2450BL14B050	2400 - 2500	50/50	1.5 dB	9.5 dB	180°±10°	2.0 dB	14-1A
2450BL14B100	2400 - 2500	50/100	1.3 dB	9.5 dB	180°±10°	2.0 dB	14-1A
2450BL14C050	2400 - 2500	50/50	1.2 dB	9.5 dB	180°±10°	2.0 dB	14-1A
2450BL14C100	2400 - 2500	50/100	1.2 dB	9.5 dB	180°±10°	1.5 dB	14-1A
2450BL14B200	2400 - 2500	50/200	1.2 dB	9.5 dB	180°±10°	2.0 dB	14-1A
2450BL14C200	2400 - 2500	50/200	1.3 dB	9.5 dB	180°±10°	2.0 dB	14-1A
2450BL15B050	2400 - 2500	50/50	1.0 dB	9.5 dB	180°±10°	2.0 dB	15-1C
2450BL15B100	2400 - 2500	50/100	1.0 dB	9.5 dB	180°±10°	2.0 dB	15-1C
2450BL15B150	2400 - 2500	50/150	1.0 dB	9.5 dB	180°±10°	2.0 dB	15-1A
2450BL15B200	2400 - 2500	50/200	1.0 dB	9.5 dB	180°±10°	2.0 dB	15-1C
2450BL15K050	2400 - 2500	50/50	1.2 dB	9.5 dB	180°±10°	2.0 dB	15-1C
2450BL15K100	2400 - 2500	50/100	1.0 dB	9.5 dB	180°±10°	2.0 dB	15-1C
2500BL14M050	2300 - 2700	50/50	1.2 dB	9.5 dB	180°±15°	1.5 dB	14-1A
2500BL14M100	2300 - 2700	50/100	1.2 dB	9.5 dB	180°±15°	1.5 dB	14-1A

Basic case size drawings for above part numbers are located on pages 39-40.

Detailed specifications and performance curves for the RF Ceramic Component line are located on our website.

CERAMIC CHIP BALUNS

Part Number	Frequency (MHz)	Impedance Unbal./Bal.	Insertion Loss (max)	Return Loss (min)	Phase Difference	Amplitude Difference (max)	Case Size
3600BL14M050	3300 - 3900	50/50	1.2 dB	9.5 dB	180°±15°	1.5 dB	14-1A
3600BL14M100	3300 - 3900	50/100	1.2 dB	9.5 dB	180°±15°	1.5 dB	14-1A
3700BL15B050	3400 - 4000	50/50	1.2 dB	9.5 dB	180°±25°	2.0 dB	15-1C
3700BL15B100	3400 - 4000	50/100	1.0 dB	9.5 dB	180°±20°	1.0 dB	15-1C
3700BL15B200	3400 - 4000	50/200	1.2 dB	9.5 dB	180°±20°	1.0 dB	15-1A
4000BL14U100	3100 - 4800	50/100	1.2 dB	9.5 dB	180°±20°	1.5 dB	14-1A
5425BL07A0200	4900 - 5950	50/200	1.2 dB	9.5 dB	180°±15°	2.0 dB	07-1
5250BL14B100	5150 - 5350	50/100	1.0 dB	9.5 dB	180°±15°	1.5 dB	14-1A
5250BL15B100	5150 - 5350	50/100	1.2 dB	9.5 dB	180°±10°	2.0 dB	15-1C
5325BL15B050	5150 - 5500	50/50	1.0 dB	9.5 dB	180°±10°	2.0 dB	15-1C
5388BL15B100	4900 - 5875	50/100	1.0 dB	9.5 dB	180°±10°	2.0 dB	15-1
5400BL14B100	4900 - 5875	50/100	1.0 dB	9.5 dB	180°±10°	1.5 dB	14-1A
5400BL15B050	4900 - 5900	50/50	1.0 dB	9.5 dB	180°±10°	2.0 dB	15-1
5400BL15B100	4900 - 5900	50/100	1.0 dB	9.5 dB	180°±10°	2.0 dB	15-1C
5400BL15B200	4900 - 5875	50/200	1.0 dB	9.5 dB	180°±10°	2.0 dB	15-1B
5400BL15K050	4900 - 5875	50/50	1.2 dB	8.5 dB	180°±10°	2.0 dB	15-1A
5500BL15U0100	3000 - 8000	50/100	1.8 dB	9.5 dB	180°±20°	2.0 dB	15-1A
5512BL15B100	5150 - 5875	50/100	1.0 dB	11.7 dB	180°±10°	2.0 dB	15-1C
5512BL15B100_V	5150 - 5875	50/100	1.0 dB	9.5 dB	180°±10°	2.0 dB	15-1
5800BL15B100	5725 - 5875	50/100	1.0 dB	9.5 dB	180°±8°	0.75 dB	15-1C
7128BL14A0100	6072 - 8184	50/100	1.0 dB	9.5 dB	180°±15°	1.5 dB	14-1

CERAMIC CHIP BALUNS, DUAL BAND

Part Number	Frequency (MHz)	Impedance Unbal./Bal.	Insertion Loss (max)	Return Loss (min)	Phase Difference	Case Size
0918BD41B050	B1: 900 - 940 B2: 1850 - 1920	50/50 50/50	1.2 dB 1.7 dB	8.5 dB 8.5 dB	180°±10° 180°±10°	41-2
0918BD41D050	B1: 900 - 940 B2: 1850 - 1920	50/50 50/50	1.2 dB 1.7 dB	8.5 dB 8.5 dB	-	See Spec Sheet

SPECIFIC RF CHIPSET IMPEDEANCE-MATCHED BALUN/FILTERS INTEGRATED PASSIVES; REFERENCE DESIGNS

Part Number	Frequency (MHz)	Unbalanced Impedance	Differential Balanced Imp.	Insertion Loss (max)	Return Loss (min)	Phase Difference
0896BM15A0001	863 - 928	50	Conj match to T.I. CC11XX and CC430	1.5 dB	9.5 dB	180°±10°
0896FB15A0100	863 - 928	50	Conj match to AT86RF212	1.5 dB	9.5 dB	180°±10°
0953BM15A0001	950 - 956	50	Conj. match to T.I. CC11XX	2.1 dB	9.5 dB	180°±10°
2450BM15B0009	2400 - 2500	50	Conj match to ZIC2410	1.5 dB	9.5 dB	180°±10°
2450FB15K0002	2400 - 2500	50	Conj match to CSR BC03, BC04(16-j40)	3 dB	9.54 dB	180°±10°
2450FB15K0003	2400 - 2500	50	Conj match to CSR BC03, BC04(20-j50)	3 dB	9.54 dB	180°±10°
2450FB15K0004	2400 - 2500	50	Conj match to CSR BC03, BC04	3.2 dB	9.5 dB	180°±10°

Basic case size drawings for above part numbers are located on pages 39-40.

Detailed specifications and performance curves for the RF Ceramic Component line are located on our website.

SPECIFIC RF CHIPSET IMPEDEANCE-MATCHED BALUN/FILTERS INTEGRATED PASSIVES; REFERENCE DESIGNS

Part Number	Frequency (MHz)	Unbalanced Impedance	Differential Balanced Imp.	Insertion Loss (max)	Return Loss (min)	Phase Difference
2450FB15K0005	2400 - 2500	50	Conj match to BC series of CSR	3.5 dB	9.5 dB	180°±10°
2450FB15K0008	2400 - 2500	50	Conj match to BC series of CSR	3.5 dB	9.5 dB	180°±10°
2450FB15L0001	2400 - 2500	50	Imp. match to AT86RF230/231 & ATmega128RFA1	1.5 dB	9.5 dB	180°±10°
2450FB15M0001	2400 - 2500	50	Conj match to MTK and BC05 chipsets	3.0 dB	9.5 dB	180°±15°
2450BM14A0002	2400 - 2500	50	Conj match to nRF24L01/nRF24L01	2.0 dB	9.5 dB	160°±15°
2450BM15A0006	2400 - 2500	50	Conj match to STLC2690	3.5 dB	14 dB	180°±10°
2450BM15A0001	2400 - 2500	50	Conj match to T.I. Chipsets CC2430 and CC2480	1.0 dB	10.0 dB	180°±15°
2450BM15B0003	2400 - 2500	50	Conj match to T.I. Chipset 2500	2.2 dB	10.0 dB	180°±12°
2450BM15B0002	2400 - 2500	50	Conjugate match to TI Chipset 2520	1.5 dB	10.0 dB	180°±15°
2450BM15A0002	2400 - 2500	50	Conjugate match to T.I. CC253X and CC2540	1.5 dB	10.0 dB	180°±15°

CERAMIC CHIP BALUN FILTER

Part Number	Frequency (MHz)	Impedance Unbal./Bal.	Insertion Loss (max)	Return Loss (min)	Phase Difference	Case Size
0783FB15A0100	779 - 787	50/100	1.5 dB	9.5 dB	180°±15°	15-1
0892FB15A0100	863 - 928	50/100	1.5 dB	11.7 dB	180°±15°	15-1
0896FB15A0100	868 - 915	50/100	1.5 dB	11.7 dB	180°±15°	15-1E
2345FB16A0100	2300 - 2390	50/100	2.8 dB	9.5 dB	180°±10°	15-1
2345FB39A0050	2300 - 2390	50/50	3.2 dB	11.7 dB	180°±10°	39-4B
2450FB14K0001	2400 - 2500	50 / 28+j64	3.5 dB	9.5 dB	180°±10°	14-1A
2450FB15A0100	2400 - 2500	50/100	1.5 dB	9.5 dB	180°±10	15-1
2450FB15K0001	2400 - 2500	50 / 16+j40	3.8 dB	9.5 dB	180°±10°	15-1
2450FB15K0002	2400 - 2500	50 / 16+j40	3.0 dB	9.54 dB	180°±10°	15-1
2450FB15K0003	2400 - 2500	50 / 20+j50	3.0 dB	9.5 dB	180°±10°	15-1
2450FB15K0004	2400 - 2500	50 / 28+j64	3.2 dB	9.5 dB	180°±10°	15-1
2450FB15A050	2400 - 2500	50/50	1.5 dB	9.5 dB	180°±10°	15-1
2450FB15M0001	2400 - 2500	50 / Conjugate match (20+j60) to MTK & BC05 Chipset	3.0 dB	9.5 dB	180°±15°	15-1
2450FB39A050	2400 - 2500	50/50	2.0 dB	9.5 dB	180°±10°	39-2
2450FB39A0150	2400 - 2500	50/150	2.5 dB	9.5 dB	180°±10°	39-2
2450FB39B100	2400 - 2500	50/100	2.0 dB	9.5 dB	180°±10°	39-2
2450FB39K001	2400 - 2500	50 / 22+j100	3.0 dB	9.5 dB	180°± 8°	See Spec Sheet
2595FB39A0050	2500 - 2690	50/50	3.2 dB	11.73 dB	180°± 10°	See Spec Sheet
2450FB39C100	2400 - 2500	50/100	3.0 dB	9.5 dB	180°± 8°	See Spec Sheet
2500FB16A0400	2300 - 2690	50/50+2.4nH	3.8 dB	9.5 dB	180°± 10°	See Spec Sheet
2595FB16A0100	2300 - 2690	50/100	2.5 dB	9.5 dB	180°± 10°	See Spec Sheet
3500FB16A0100	3400 - 3600	50/100	2.7 dB	9.5 dB	180°± 10°	See Spec Sheet
3500FB39A0050	3400 - 3600	50/50	2.9 dB	9.5 dB	180°± 12°	See Spec Sheet

Basic case size drawings for above part numbers are located on pages 39-40.

Detailed specifications and performance curves for the RF Ceramic Component line are located on our website.

CERAMIC CHIP DIPLEXERS - LPF / HPF

Part Number	Frequency (MHz)	Insertion Loss (max)	Attenuation Low Band	Attenuation High Band	Return Loss (min)
0859DP18A1920_	824 - 894 1850 - 1990	0.75 dB 0.55 dB	20 dB min	20 dB min	12 dB
0859DP18B1920	824 - 894 1850 - 1990	0.6 dB 0.65 dB	20 dB min	20 dB min	12 dB
0892DP14A1850_	824 - 960 1710 - 1990	0.5 dB 0.8 dB	15 dB min	25 dB min	12 dB
0892DP14B1850	824 - 960 1710 - 1990	0.6 dB 0.9 dB	15 dB min	20 dB min	9.5 dB
0892DP15A1940	824 - 960	0.7 dB	16 min. @ 1648 - 1830 MHz 22 min. @ 2472 - 2745 MHz 15 min. @ 3300 - 3680 MHz 12 min. @ 4100 - 4600 MHz	18 min. @ 3420 - 3820 MHz 20 min. @ 5130 - 5730 MHz 15 min. @ 6800 - 7680 MHz	15 dB
	1710 - 1990	0.8 dB	15 min. @ 4920 - 5520 MHz 15 min. @ 5740 - 6440 MHz 15 min. @ 6560 - 7360 MHz 18 min. @ 3420 - 3820 MHz 20 min. @ 5130 - 5730 MHz 15 min. @ 6800 - 7680 MHz		
0892DP15D1940	824 - 960	0.7 dB	16 min. @ 1648 - 1830 MHz 22 min. @ 2472 - 2745 MHz 15 min. @ 3300 - 3680 MHz 12 min. @ 4100 - 4600 MHz	18 min. @ 3420 - 3820 MHz 20 min. @ 5130 - 5730 MHz 15 min. @ 6800 - 7680 MHz	15 dB
	1710 - 1990	0.8 dB	15 min. @ 4920 - 5520 MHz 15 min. @ 5740 - 6440 MHz 15 min. @ 6560 - 7360 MHz 18 min. @ 3420 - 3820 MHz 20 min. @ 5130 - 5730 MHz 15 min. @ 6800 - 7680 MHz		
0920DP18A1795_	880 - 960 1710 - 1880	0.75 dB 0.55 dB	20 dB min	20 dB min	12 dB
0967DP18A1795_	954 - 980 1710 - 1880	0.75 dB 0.55 dB	20 dB min.	20 dB min.	12 dB
2400DP39A5425	2300 - 2500 4900 - 5950	1.8 dB 1.5 dB	20 dB min	20 dB min	9.5 dB
2450DP15A5512	2400 - 2500 5150 - 5875	0.70 dB 0.90 dB	20 dB min	15 dB min	9.5 dB
2450DP15B5512	2400 - 2500 5150 - 5875	0.70 dB 0.90 dB	20 dB min	15 dB min	9.5 dB

Basic case size drawings for above part numbers are located on pages 39-40.

Detailed specifications and performance curves for the RF Ceramic Component line are located on our website.

CERAMIC CHIP DIPLEXERS - LPF / BPF

Part Number	Frequency (MHz)	Insertion Loss (max)	Attenuation Low Band	Attenuation High Band	Return Loss (min)
0892DP15B1850	824 - 960 1710 - 1990	1.3 dB 1.35 dB	16 dB min @ 1628 - 1830 MHz 30 dB min @ 2472 - 2745 MHz 27 dB min @ 3296 - 4575 MHz	18 dB min @ 824 - 960 MHz 20 dB min @ 3420 - 3820 MHz 27 dB min @ 5130 - 5730 MHz	9.5 dB
2450DP15D5400	2400 - 2500 4900 - 5875	0.7 dB 1.4 dB	20 dB min. @ 4.8 - 6.0 GHz 20 dB min. @ 7.2 - 7.5 GHz	19 dB min @ 1.8 - 2.5 GHz 20 dB min. @ 10.3 - 10.7 GHz	9.5 dB
2450DP15E5400	2400 - 2500 4900 - 5900	0.7 dB 1.6 dB	20 dB min @ 4.8 - 6.0 GHz 17 dB min @ 1.8 - 2.5 GHz	20 dB min @ 7.2 - 7.5 GHz 20 dB typ. @ 10.3 - 10.7 GHz	9.5 dB
2450DP15F5400	2400 - 2500 4900 - 5900	0.7 dB 1.0 dB	18 dB min @ 4.8 - 6.0 GHz 19 dB min @ 1.8 - 2.5 GHz	18 dB min @ 7.2 - 7.5 GHz 25 dB typ. @ 10.3 - 10.7 GHz	9.5 dB
2450DP15G5400	2400 - 2500 4900 - 5900	0.7 dB 1.0 dB	18 dB min @ 4.8 - 6.0 GHz 19 dB min @ 1.8 - 2.5 GHz	18 dB min @ 7.2 - 7.5 GHz 25 dB typ. @ 10.3 - 10.7 GHz	9.5 dB
2450DP15H5400	2400 - 2500 4900 - 5900	0.7 dB 1.0 dB	18 dB min @ 4.8 - 6.0 GHz 19 dB min @ 1.8 - 2.5 GHz	18 dB min @ 7.2 - 7.5 GHz 25 dB typ. @ 10.3 - 10.7 GHz	9.5 dB
2450DP15J5400	2400 - 2500 4900 - 5900	0.7 dB 1.0 dB	18 dB min @ 4.8 - 6.0 GHz 19 dB min @ 1.8 - 2.5 GHz	18 dB min @ 7.2 - 7.5 GHz 25 dB typ. @ 10.3 - 10.7 GHz	9.5 dB

CERAMIC CHIP DIPLEXERS - BPF / NF

Part Number	Frequency (MHz)	Insertion Loss	Attenuation	Case Size
0500DP44A1215	950 - 1450	3.6 max. (25°C)	30.0 min. @ 200 - 750MHz	See Spec Sheet
		3.9 max. (-40 - +85°C)	30.0 min. @ 1650 - 2150MHz	
	200 - 750	2.0 max. (25°C)	30.0 min. @ 950 - 1450MHz	
		2.3 max. (-40 - +85°C)		
	1650 - 2150	3.5 max. (25°C)		
		3.8 max. (-40 - +85°C)		

CERAMIC CHIP DIPLEXERS - BPF / NF

Part Number	Frequency (MHz)	Insertion Loss	Attenuation Low Band	Attenuation High Band	Return Loss
1407DP15A2450	824 - 960	0.6 dB	15 min. @ 2400 - 2500 MHz	20 min. @ 824 - 1990 MHz	9.5 dB min.
	1710 - 1880	1.0 dB			9.5 dB min.
	1990	1.5 dB			-
	2400 - 2500	2.0 dB			9.5 dB min.

Basic case size drawings for above part numbers are located on pages 39-40.

Detailed specifications and performance curves for the RF Ceramic Component line are located on our website.

Case 18-4

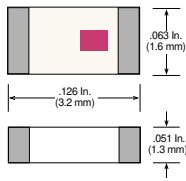

Case 42-1

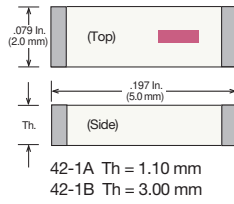

Case 42-2

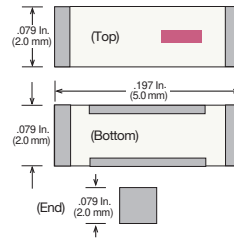

Case 43-1

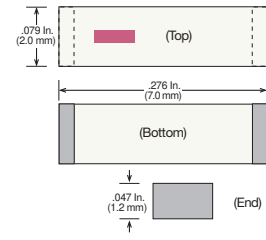

Case 43-2

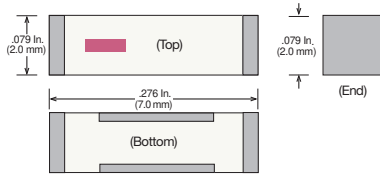

Case 43-3

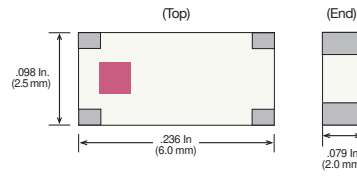

Case 44-1

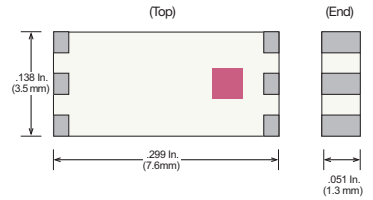

Case 44-2

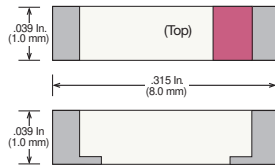

Case 45-1

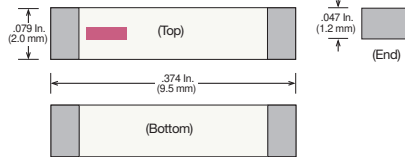

Case 46-1

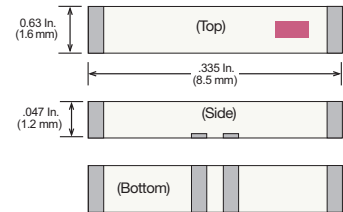

Case 47-1

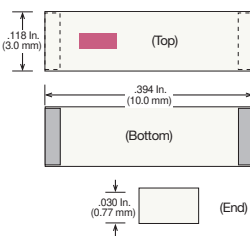

Case 50

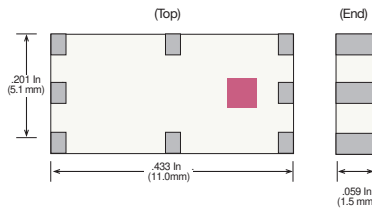

Case 51-1

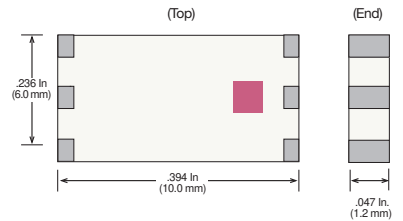

IPC EXCEPT ANTENNA

Case 07-1 (EIA 0402/ 1005)

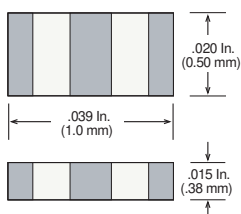

Case 07-2 (EIA 0402/ 1005)

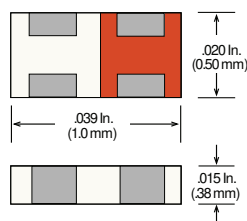

Case 14-1 (EIA 0603/ 1608)

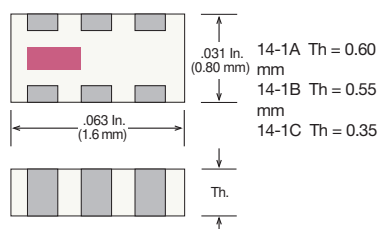

Case 14-2

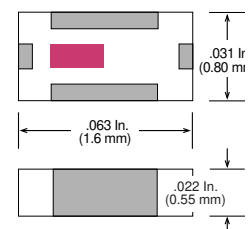

Case 15-1 (EIA 0805 / 2012)

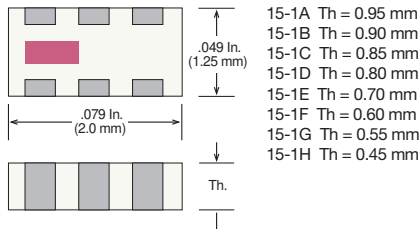

Case 15-2 (EIA 0805 / 2012)

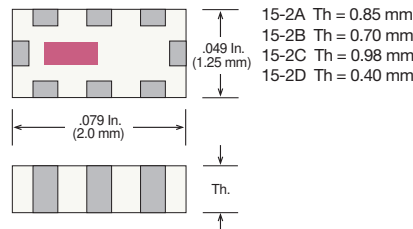

Case 15-3 (EIA 0805 / 2012)

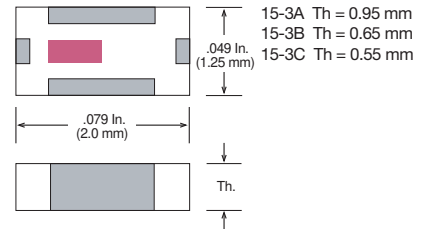

Case 15-4 (EIA 0805 / 2012)

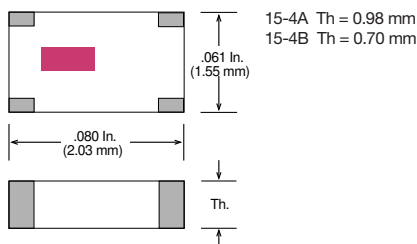

Case 18-1 (EIA 1206 / 3216)

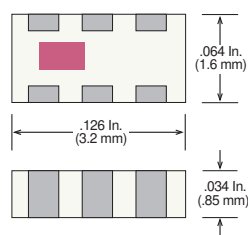

Case 18-2 (EIA 1206 / 3216)

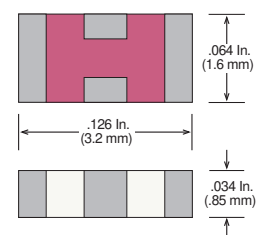

Case 18-3 (EIA 1206 / 3216)

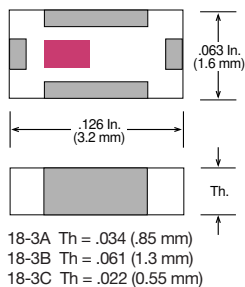

Case 18-4 (EIA 1206 / 3216)

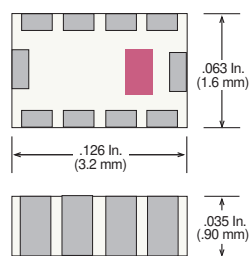

Case 39-1 (2520)

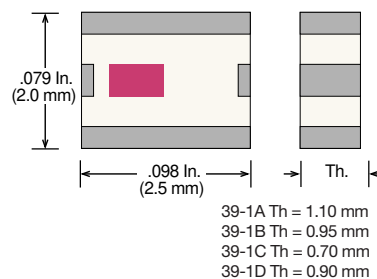

Case 39-2 (2520)

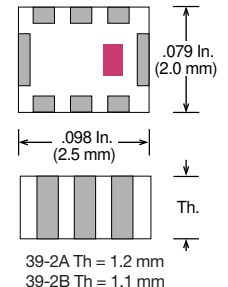

Case 39-3 (2520)

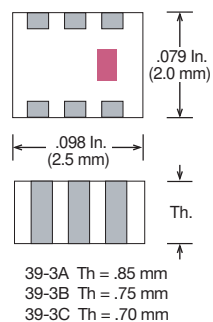

Case 39-4 (2520)

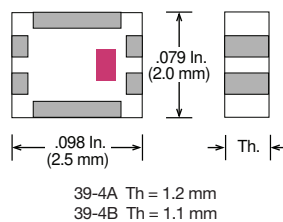

Case 41-1 (EIA 1210 / 3225)

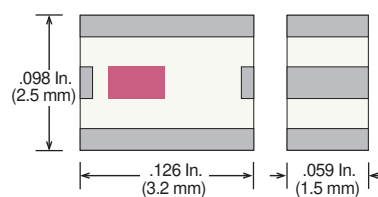

Case 41-2 (EIA 1210 / 3225)

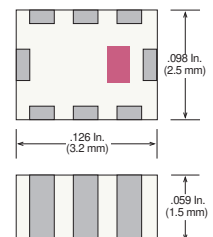

Detailed specifications and performance curves for the RF Ceramic Component line are located on our website.