



Chipsmall Limited consists of a professional team with an average of over 10 year of expertise in the distribution of electronic components. Based in Hongkong, we have already established firm and mutual-benefit business relationships with customers from,Europe,America and south Asia,supplying obsolete and hard-to-find components to meet their specific needs.

With the principle of “Quality Parts,Customers Priority,Honest Operation,and Considerate Service”,our business mainly focus on the distribution of electronic components. Line cards we deal with include Microchip,ALPS,ROHM,Xilinx,Pulse,ON,Everlight and Freescale. Main products comprise IC,Modules,Potentiometer,IC Socket,Relay,Connector.Our parts cover such applications as commercial,industrial, and automotives areas.

We are looking forward to setting up business relationship with you and hope to provide you with the best service and solution. Let us make a better world for our industry!



Contact us

Tel: +86-755-8981 8866 Fax: +86-755-8427 6832

Email & Skype: info@chipsmall.com Web: www.chipsmall.com

Address: A1208, Overseas Decoration Building, #122 Zhenhua RD., Futian, Shenzhen, China



25000N series

Professional slide switches



DISTINCTIVE FEATURES

Professional grade slide switches for PC boards

Approved according to UL 1054

Wave solderable

Available with flush, high and side actuator

Various actuator lengths



ELECTRICAL SPECIFICATIONS

- Max. current/voltage rating with resistive load :
 - silver contacts (A) : 1 A 30 VDC
 - gold plated brass contacts (LD) : 100 mA 30 VDC
- Minimum load :
 - silver contacts (A) : 100 mA 10 V
 - gold plated brass contacts (LD) : 10 μ A 5 VDC - 10 mA 50 mV
- Initial contact resistance :
 - silver contacts (A) : 10 m Ω max.
 - gold plated brass contacts (LD) : 50 m Ω max.
- Insulation resistance : 1,000 M Ω min. at 500 VDC
- Dielectric strength :
 - 1,000 Vrms 50 Hz min. between terminals
 - 2,000 Vrms 50 Hz min. between poles
 - 2,000 Vrms 50 Hz min. between terminals and frame
- Electrical life : 10,000 cycles at full load
- Low level or mechanical life : 20,000 cycles



GENERAL SPECIFICATIONS

- Operating temperature : -40 °C to +85 °C (-40 °F to +185 °F)
- Overall length : 14 mm (.551)
- Actuator height (outside case) :
 - high : 2.80 mm (.110)
 - extra high : 6 mm (.236)
 - side : 2.30 mm (.090)
 - long side : 6 mm (.236)
- Travel : 4 mm (.157)

The company reserves the right to change specifications without notice.



25000N series

Professional slide switches



MATERIALS

- Case : PBT
- Actuator : polyamide, glass filled
- Cover : polyamide, glass filled
- Contacts
 - A : silver
 - LD : brass, gold plated
- Terminal seal : epoxy

APEM products may be recycled at end-of-life for the re-claiming of valuable metal components.

AGENCY APPROVAL



2 A 250 VAC
4 A 125 VAC

Availability : consult factory for details of approved models.

Marking : to order switches marked UL, complete the "Options and Approvals" box of ordering format.



POSITIONS AND CONNECTIONS

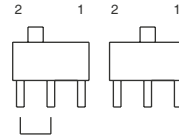

Function 6 : ON - ON
Function 9 : ON OFF ON



ELECTRICAL FUNCTIONS



PCB MOUNTING

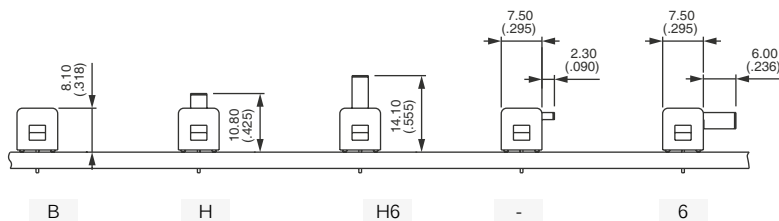

25000N series

Professional slide switches



BUILD YOUR PART NUMBER

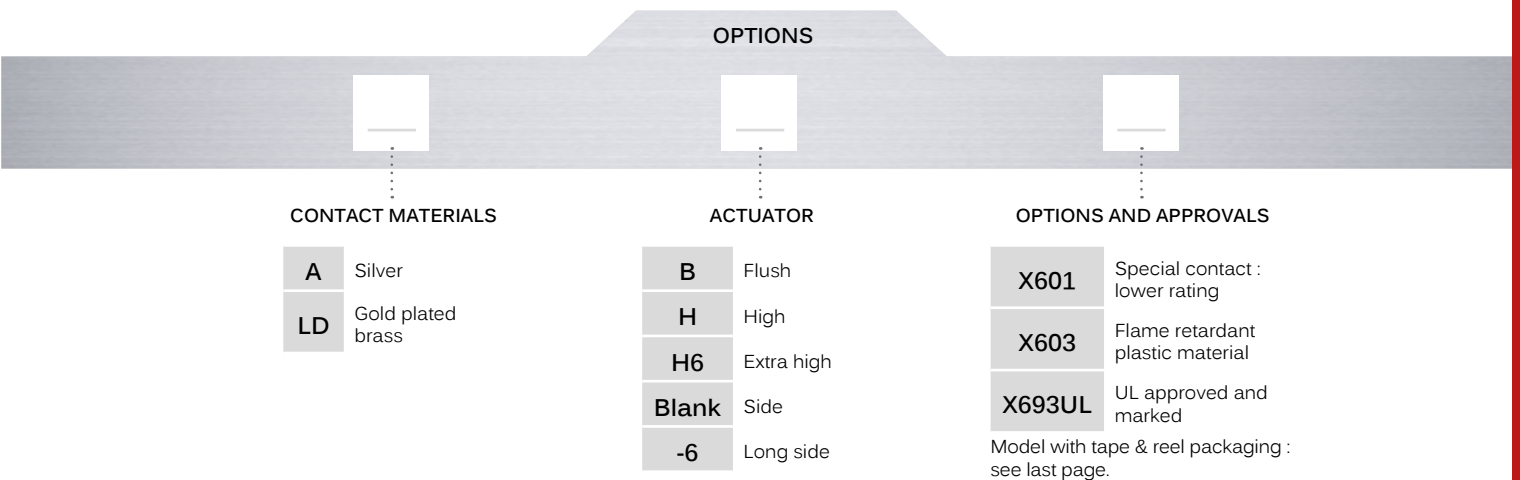
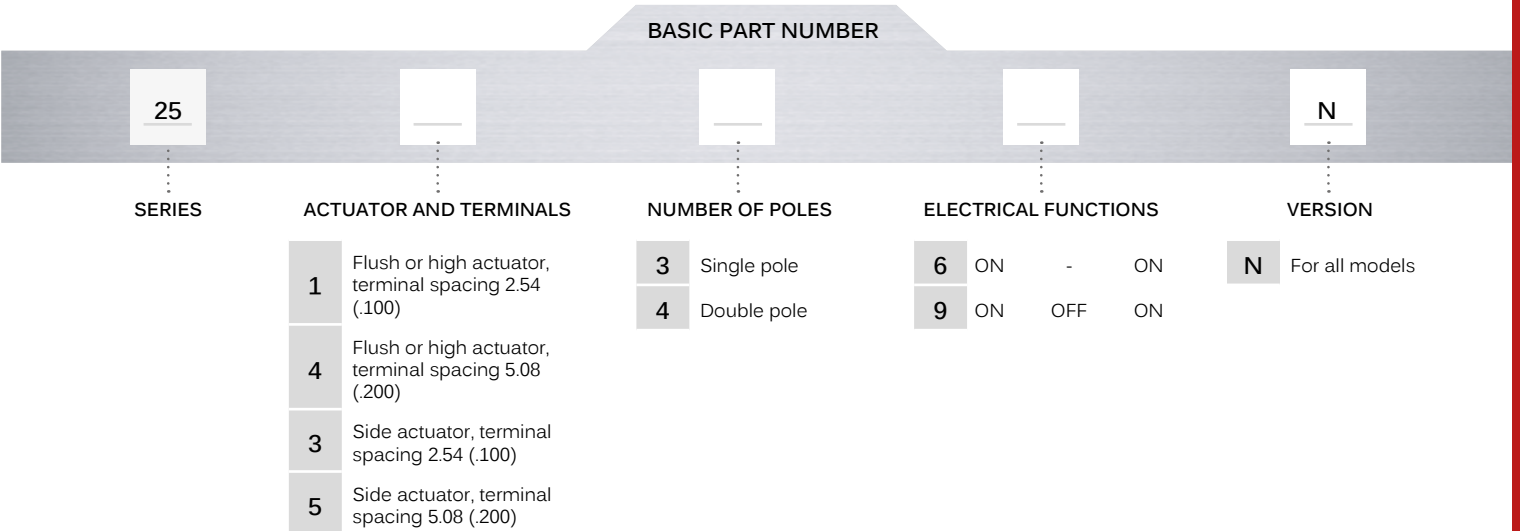

ABOUT THIS SERIES

On the following pages, you will find successively basic part numbers of switches and options in the same order as in above chart.

Notice : please note that not all combinations of above numbers are available. Refer to the following pages for further information.

25000N series

Professional slide switches

FLUSH ACTUATOR : 25000NB



Terminal spacing
2.54 (.100)

Single pole

25136N B

25139N B

Double pole

25146N B

25149N B

Terminal spacing
5.08 (.200)

Single pole

25436N B

25439N B

Double pole

25446N B

25449N B

HIGH ACTUATOR : 25000NH



Terminal spacing
2.54 (.100)

Single pole

25136N H

25139N H

Double pole

25146N H

25149N H

Terminal spacing
5.08 (.200)

Single pole

25436N H

25439N H

Double pole

25446N H

25449N H

EXTRA HIGH ACTUATOR : 25000NH6



Terminal spacing
2.54 (.100)

Single pole

25136N H6

25139N H6

Double pole

25146N H6

25149N H6

Terminal spacing
5.08 (.200)

Single pole

25436N H6

25439N H6

Double pole

25446N H6

25449N H6

SIDE ACTUATOR : 25000N



Terminal spacing
2.54 (.100)

Single pole

25336N

25339N

Double pole

25346N

25349N

Terminal spacing
5.08 (.200)

Single pole

25536N

25539N

Double pole

25546N

25549N

Shown with 2.54 mm terminal spacing

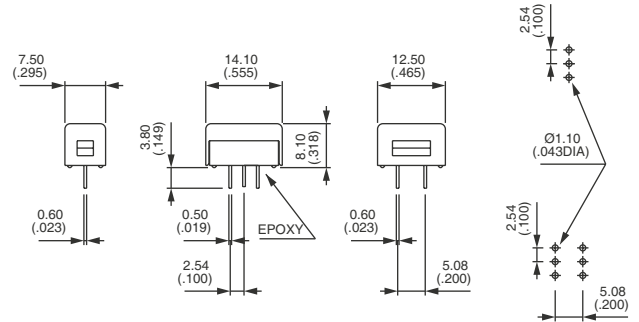

Shown with 5.08 mm terminal spacing

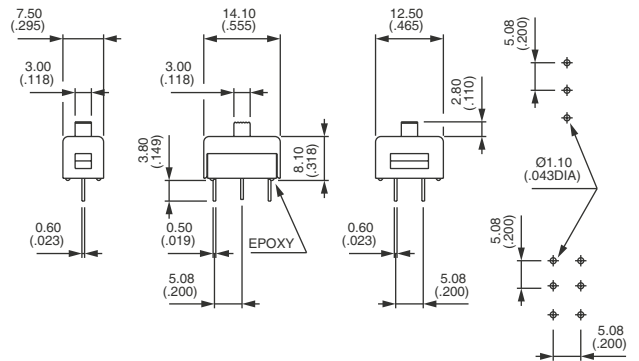

Shown with 5.08 mm terminal spacing

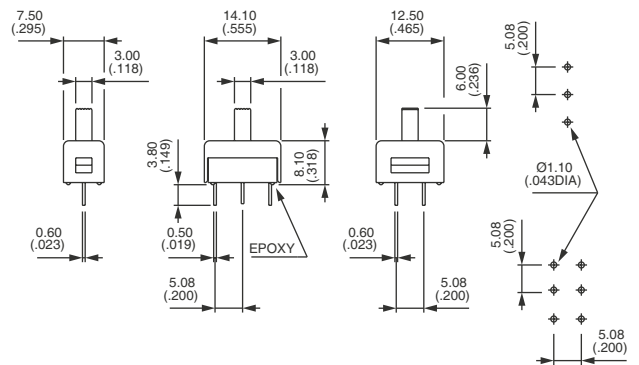

Shown with 2.54 mm terminal spacing

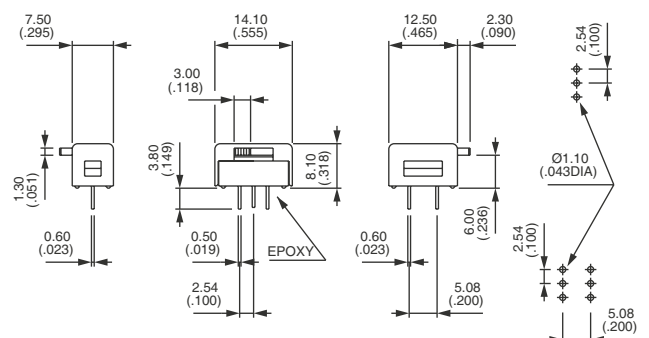

25000N series

Professional slide switches

LONG SIDE ACTUATOR : 25000N-6



Terminal spacing
2.54 (.100)

Single pole

25336N -6

25339N -6

Double pole

25346N -6

25349N -6

Terminal spacing
5.08 (.200)

Single pole

25536N -6

25539N -6

Double pole

25546N -6

25549N -6

Shown with 2.54 mm terminal spacing

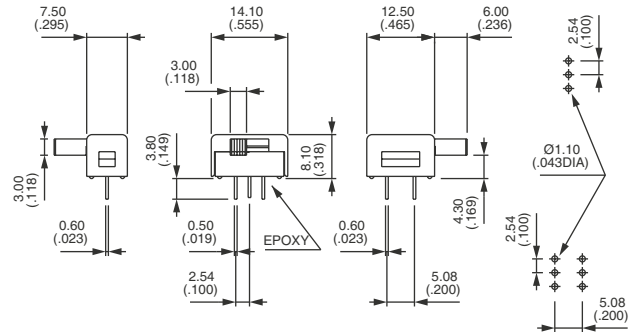

CONTACT MATERIALS



- A Silver
- LD Brass, gold plated

ACTUATORS

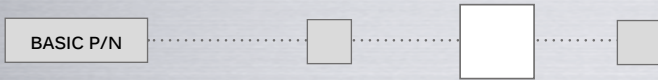

Already included in the above part numbers.

- B Flush actuator
- H High actuator
- H6 Extra high
- Blank Side
- 6 Long side

OPTIONS AND APPROVALS

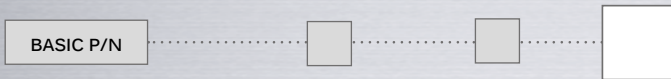

- X601 Silver plated brass contacts - Lower rating 3 VA 30 VDC. Min. quantity : 5,000 pieces per model and shipment.
- X693 Flame retardant plastic materials
- X693UL Switches approved and marked UL (silver contacts only)

MODEL WITH TAPE AND REEL PACKAGING



25436NLDH X693-02 R
On request.