



Chipsmall Limited consists of a professional team with an average of over 10 year of expertise in the distribution of electronic components. Based in Hongkong, we have already established firm and mutual-benefit business relationships with customers from,Europe,America and south Asia,supplying obsolete and hard-to-find components to meet their specific needs.

With the principle of “Quality Parts,Customers Priority,Honest Operation,and Considerate Service”,our business mainly focus on the distribution of electronic components. Line cards we deal with include Microchip,ALPS,ROHM,Xilinx,Pulse,ON,Everlight and Freescale. Main products comprise IC,Modules,Potentiometer,IC Socket,Relay,Connector.Our parts cover such applications as commercial,industrial, and automotives areas.

We are looking forward to setting up business relationship with you and hope to provide you with the best service and solution. Let us make a better world for our industry!



Contact us

Tel: +86-755-8981 8866 Fax: +86-755-8427 6832

Email & Skype: info@chipsmall.com Web: www.chipsmall.com

Address: A1208, Overseas Decoration Building, #122 Zhenhua RD., Futian, Shenzhen, China



PART NUMBER: 265HC3500K2EM8

Conduction Cooled (High Density Resonant)

Parts are RoHS compliant

ELECTRICAL SPECIFICATIONS

Capacitance: 2.6 μ F

AC Current: 650 A

ESR: 0.2 milliohms at 100 kHz and 20°C

Self Inductance: 5 Nanohenries maximum

Tolerance: -10 % , +10 %

Temperature Range: -40°C to +85°C

Maximum Core Temperature: 85°C

Resonant Frequency: 72-85 kHz

Maximum power (KVAR): 300

VAC: 500 Volts AC

PHYSICAL DIMENSIONS

Length (L): 56 mm, 0.5 mm

Height (H): 66 mm, +/-0.5 mm

Thickness (B): 30.2 mm, +/-0.1 mm

LEAD STYLE: 2EM8

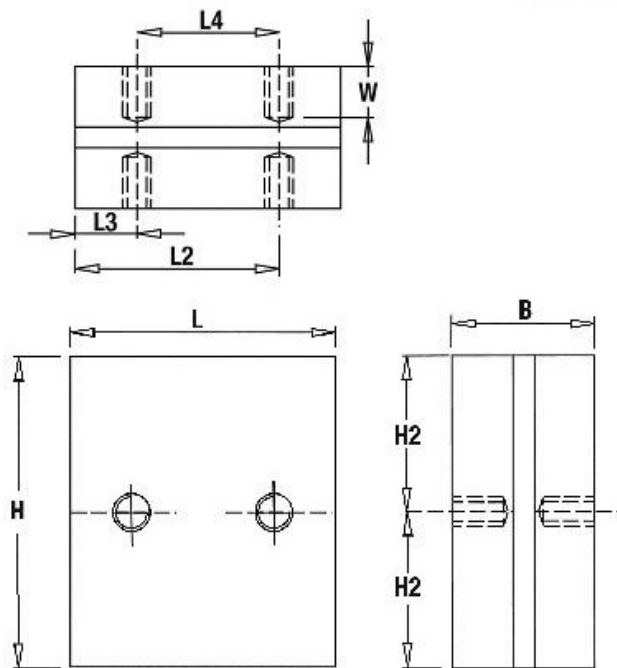

L	H	B	W	L2	L3
56+0.5	66+0.5	30.2+0.1	9	43	13
Mounting holes: M8 full thread with SS heli					
Tightening torque: 15Nm MAX					