



Chipsmall Limited consists of a professional team with an average of over 10 year of expertise in the distribution of electronic components. Based in Hongkong, we have already established firm and mutual-benefit business relationships with customers from,Europe,America and south Asia,supplying obsolete and hard-to-find components to meet their specific needs.

With the principle of “Quality Parts,Customers Priority,Honest Operation,and Considerate Service”,our business mainly focus on the distribution of electronic components. Line cards we deal with include Microchip,ALPS,ROHM,Xilinx,Pulse,ON,Everlight and Freescale. Main products comprise IC,Modules,Potentiometer,IC Socket,Relay,Connector.Our parts cover such applications as commercial,industrial, and automotives areas.

We are looking forward to setting up business relationship with you and hope to provide you with the best service and solution. Let us make a better world for our industry!



Contact us

Tel: +86-755-8981 8866 Fax: +86-755-8427 6832

Email & Skype: info@chipsmall.com Web: www.chipsmall.com

Address: A1208, Overseas Decoration Building, #122 Zhenhua RD., Futian, Shenzhen, China



IB IL AI 4/U-PAC

**Inline analog input terminal,
4 inputs for connecting voltage signals**

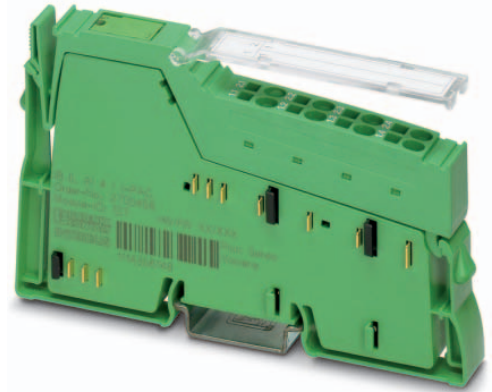

Data sheet
8081_en_01_C01

© PHOENIX CONTACT 2015-04-14

1 Description

The terminal is designed for use within an Inline station.
It is used to acquire analog voltage signals.

Features

- 4 analog, bipolar, differential input channels for connecting voltage signals
- Connection of sensors in 2-wire technology
- Voltage ranges: 0 V ... 10 V, -10 V ... +10 V
- Mean-value generation of the inputs
- Process data update of all channels in 250 μ s
- Diagnostic and status indicators



This data sheet is only valid in association with the IL SYS INST UM E user manual.



Make sure you always use the latest documentation.
It can be downloaded from the product at www.phoenixcontact.net/catalog.

2	Table of contents	
1	Description	1
2	Table of contents	2
3	Ordering data	3
4	Technical data	4
5	Tolerance data.....	6
6	Internal circuit diagram	7
7	Terminal point assignment.....	8
8	Connection notes	8
9	Installation instructions	8
10	Connection examples	8
11	Electrical isolation.....	9
12	Local status and diagnostic indicators	9
13	Process data.....	9
	13.1 OUT process data.....	9
	13.2 IN process data	10
	13.3 Read firmware version	10
14	Measured value representation in the different formats	11
	14.1 IB IL format	11
	14.2 S7-compatible format	11

3 Ordering data

Description	Type	Order No.	Pcs. / Pkt.
Inline analog input terminal, complete with accessories (connector and labeling field), inputs: 0-10 V, ± 10 V, 2-wire connection method	IB IL AI 4/U-PAC	2700459	1
Accessories	Type	Order No.	Pcs. / Pkt.
Shield connection clamp, for shield on busbars, contact resistance < 1 mOhm (Assembly)	SK 8	3025163	10
Shield connection clamp, for shield on busbars, contact resistance < 1 mOhm (Assembly)	SK 14	3025176	10
Shield connection clamp, for shield on busbars, contact resistance < 1 mOhm (Assembly)	SK 20	3025189	10
Shield connection clamp, for shield on busbars, contact resistance < 1 mOhm (Assembly)	SK 35	3026463	10
Support for busbars (Assembly)	AB-SK	3025341	10
Support, Length: 95.5 mm, Width: 6.2 mm, Color: gray (Assembly)	AB-SK 65	3026489	10
Support, Length: 10 mm, Width: 56 mm, Height: 20 mm, Color: silver (Assembly)	AB-SK/E	3026476	10
PEN conductor busbar, 3mm x 10 mm, length: 1000 mm (Assembly)	NLS-CU 3/10 SN 1000MM	0402174	10
Power terminal block, Connection method Screw connection, Load current : 41 A, Cross section: 0.5 mm ² - 6 mm ² , Width: 7 mm, Color: silver	AK 4	0404017	50
Power terminal block, Connection method Screw connection, Load current : 41 A, Cross section: 0.5 mm ² - 6 mm ² , Width: 7 mm, Color: green-yellow	AKG 4 GNYE	0421029	50
Power terminal block, Connection method Screw connection, Load current : 41 A, Cross section: 0.5 mm ² - 6 mm ² , Width: 7 mm, Color: black	AKG 4 BK	0421032	50
Documentation	Type	Order No.	Pcs. / Pkt.
User manual, English, Automation terminals of the Inline product range	IL SYS INST UM E	-	-
Data sheet, English, INTERBUS addressing	DB GB IBS SYS ADDRESS	-	-

4 Technical data

Dimensions (nominal sizes in mm)

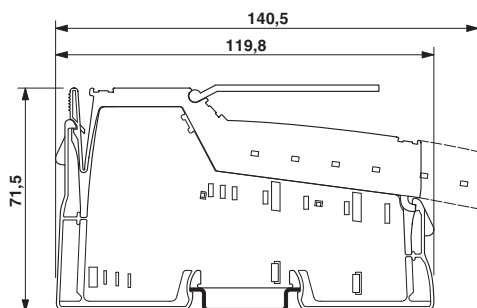

Width	12.2 mm
Height	119.8 mm
Depth	71.5 mm
Note on dimensions	Housing dimensions

General data

Color	Green
Weight	66 g (With connector)
Ambient temperature (operation)	-25 °C ... 55 °C
Ambient temperature (storage/transport)	-25 °C ... 85 °C
Permissible humidity (operation)	10 % ... 95 % (according to DIN EN 61131-2)
Permissible humidity (storage/transport)	10 % ... 95 % (according to DIN EN 61131-2)
Air pressure (operation)	70 kPa ... 106 kPa (up to 3000 m above sea level)
Air pressure (storage/transport)	70 kPa ... 106 kPa (up to 3000 m above sea level)
Degree of protection	IP20
Protection class	III, IEC 61140, EN 61140, VDE 0140-1

Connection data Inline connectors

Connection method	Spring-cage connection
Conductor cross section, solid	0.08 mm ² ... 1.5 mm ²
Conductor cross section, stranded	0.08 mm ² ... 1.5 mm ²
Conductor cross section [AWG]	28 ... 16

Interface Inline local bus

Connection method	Inline data jumper
Transmission speed	500 kBit/s
Transmission physics	Copper

Inline potential routing / Power consumption

Communications power U_L	7.5 V DC (via voltage jumper)
Current consumption from U_L	Typ. 55 mA
I/O supply voltage U_{ANA}	24 V DC
Current consumption from U_{ANA}	Typ. 30 mA
Power consumption	Typ. 0.94 W (total)

Analog inputs

Number of inputs	4 (differential inputs, voltage)
Connection method	2-wire
Resolution A/D	12 bit
A/D conversion time	max. 6.5 μ s
Measured value representation	12 bits (11 bits + sign bit)
Data formats	IB IL, S7-compatible
Process data update	Typ. 250 μ s (all channels)
Filtering	None or mean-value generation over 4, 16, or 32 measured values
Overload protection	\pm 30 V DC, maximum
Voltage input signal	0 V ... 10 V (Default) , -10 V ... 10 V
Input resistance of voltage input	Typ. 324 k Ω
Limit frequency (3 dB)	300 Hz
Open circuit response	Goes to 0 V
Common mode voltage range signal - ground	max. 50 V

Programming Data

ID code (hex)	7F
ID code (dec.)	127
Length code (hex)	04
Length code (dec.)	04
Process data channel	64 Bit
Input address area	8 Byte
Output address area	8 Byte
Parameter channel (PCP)	0 Byte
Register length (bus)	64 Bit

PROFIBUS telegram data

Required parameter data	10 Byte
Need for configuration data	5 Byte

Error messages to the higher level control or computer system

Failure of the internal I/O supply	I/O error message sent to the bus coupler
I/O supply failure	Message in the diagnostic code (in the IB IL format)
Overrange or underrange	Message in the diagnostic code (in the IB IL format)
Configuration invalid	Message in the diagnostic code (in the IB IL format)

Electrical isolation/isolation of the voltage areas

5 V supply, incoming remote bus/7.5 V supply (bus logics)	500 V AC, 50 Hz, 1 min
5 V supply, outgoing remote bus/7.5 V supply (bus logics)	500 V AC, 50 Hz, 1 min
7.5 V supply (bus logic), 24 V supply U_{ANA} / I/O	500 V AC, 50 Hz, 1 min
7.5 V supply (bus logic), 24 V supply U_{ANA} /functional earth ground	500 V AC, 50 Hz, 1 min
I/O / functional earth ground	500 V, 50 Hz, 1 s

Conformance with EMC Directive 2004/108/EC**Noise immunity test in accordance with EN 61000-6-2**

Electrostatic discharge (ESD) EN 61000-4-2/IEC 61000-4-2	Criterion B; 6 kV contact discharge, 8 kV air discharge
Electromagnetic fields EN 61000-4-3/IEC 61000-4-3	Criterion A; Field intensity: 10 V/m
Fast transients (burst) EN 61000-4-4/IEC 61000-4-4	Criterion B, 2 kV
Transient surge voltage (surge) EN 61000-4-5/IEC 61000-4-5	Criterion B; supply lines DC: \pm 1 kV/ \pm 1 kV (symmetrical/asymmetrical); shielded I/O cables: \pm 1 kV

Conformance with EMC Directive 2004/108/EC

Conducted interference EN 61000-4-6/IEC 61000-4-6

Criterion A; Test voltage 10 V

Noise emission test according to EN 61000-6-3

Radio interference properties EN 55022

Class A

ApprovalsFor the latest approvals, please visit www.phoenixcontact.net/catalog.

5 Tolerance data

The following applies for tolerance values:

The data is valid for nominal operation ($U_A = 24\text{ V}$ in the default configuration (unless documented otherwise).

Default configuration: 16-sample mean-value, IB IL format

Tolerances at $T_A = 25^\circ\text{C}$; 500 kbps, without mean-value

	Absolute		Relative	
	Typ.	Max.	Typ.	Max.
0 V ...10 V, $\pm 10\text{ V}$	$\pm 20\text{ mV}$	$\pm 50\text{ mV}$	$\pm 0.2\%$	$\pm 0.5\%$

Typical data contains offset error, gain error, and linearity error in the respective default setting.

All tolerances indicated as a percentage are related to the positive measuring range final value.

Please also observe the values for temperature drift and the tolerances under influences of electromagnetic interferences.

Tolerance and temperature response at $T_A = -25^\circ\text{C}$... $+55^\circ\text{C}$

	Drift	
	Typical	Maximum
0 V ...10 V, $\pm 10\text{ V}$	$\pm 75\text{ ppm/K}$	$\pm 100\text{ ppm/K}$

The drift values refer to the relevant measuring range final value.

Tolerances influenced by electromagnetic interference

Electromagnetic fields	EN 61000-4-3/ IEC 61000-4-3	$< \pm 1.0\%$
Fast transients (burst)	EN 61000-4-4/ IEC 61000-4-4	$< \pm 1.0\%$
Conducted interference	EN 61000-4-6/ IEC 61000-4-6	$< \pm 1.0\%$

Additional tolerances may occur due to the influence of high-frequency electromagnetic interference caused by wireless transmission systems in the near vicinity. The values specified refer to nominal operation in the event of direct interference to components without additional shielding such as a steel cabinet, etc.

The above mentioned tolerances can be reduced by providing further shielding measures for the I/O module (e.g., use of a shielded control box/control cabinet, etc.).

6 Internal circuit diagram

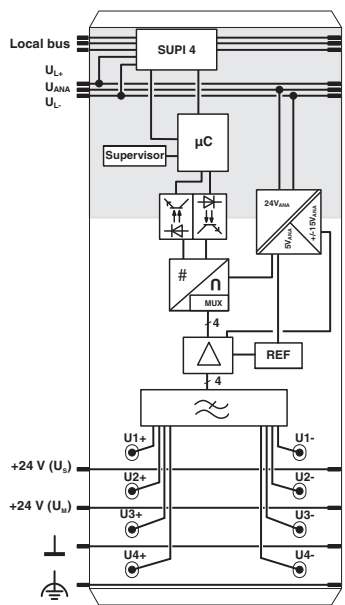











Figure 1 Internal wiring of the terminal points

Key:

-  Protocol chip
-  Microprocessor
-  Hardware monitoring
-  Optocoupler
-  Power supply unit with electrical isolation
-  Analog-digital converter with integrated multiplexer
-  Input amplifier
-  Low pass filter
-  Electrically isolated area
-  Reference voltage source



Explanation for other used symbols has been provided in the IL SYS INST UM E user manual.

7 Terminal point assignment

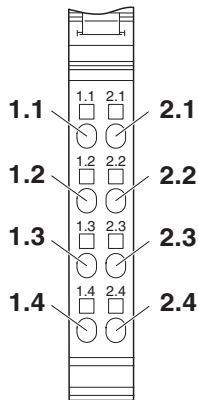

Figure 2 Terminal point assignment

Terminal point	Signal	Meaning
1.1	+U1	Positive voltage connection for channel 1
1.2	+U2	Positive voltage connection for channel 2
1.3	+U3	Positive voltage connection for channel 3
1.4	+U4	Positive voltage connection for channel 4
2.1	-U1	Negative voltage connection for channel 1
2.2	-U2	Negative voltage connection for channel 2
2.3	-U3	Negative voltage connection for channel 3
2.4	-U4	Negative voltage connection for channel 4

8 Connection notes

Always connect the analog sensors using shielded, twisted pair cables.

Connect the shielding with the shielding accessories given in the ordering data.

Insulate the shielding at the sensor or connect it with a high resistance and a capacitor to the PE potential.

9 Installation instructions

High current flowing through potential jumpers U_M and U_S leads to a temperature rise in the potential jumpers and inside the terminal. To keep the current flowing through the potential jumpers of the analog terminals as low as possible, always place the analog terminals after all the other terminals at the end of the main circuit (for the sequence of the Inline terminals: see also IL SYS INST UM E user manual).

10 Connection examples

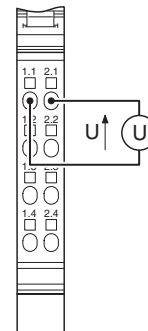

Figure 3 Connector for voltage measurement

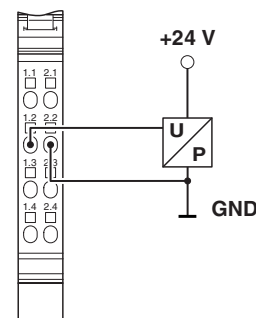

Figure 4 Differential voltage input with active 3-wire transmitter

11 Electrical isolation

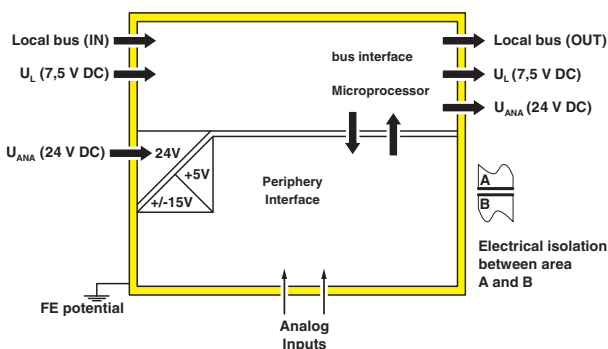

Figure 5 Electrical isolation of the individual function areas

12 Local status and diagnostic indicators

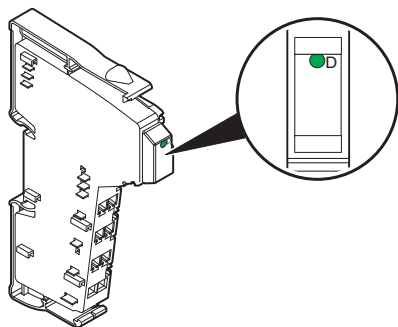

Figure 6 Local status and diagnostic indicators

Designation	Color	Meaning
D	green	Diagnostics (bus and logic voltage)



For detailed information on diagnostics, please refer to the IL SYS INST UM E user manual.

Function identification

Yellow

13 Process data

The terminal uses four input process data words and four output process data words.

Each channel is mapped to a word.

The analog values are transmitted via the input process data. The configuration is specified via the output process data.

13.1 OUT process data

The terminal can be configured channel-by-channel with the output process data.

Order of the process data words:

OUT1	OUT2	OUT3	OUT4
Channel 1	Channel 2	Channel 3	Channel 4

Assignment of the configuration words (OUT1 ... OUT4):

15	14	13	12	11	10	9	8	7	6	5	4	3	2	1	0
Config-uration	0	0	0	0	0	Filter	0	0	0	0	For-mat	Measur-ing range			

Bit 15

Code (bin)	Configuration
0	Do not accept
1	Accept

The configuration specified in the word is accepted if bit 15 is set. If bit 15 is not set, the last accepted configuration is used.

The configuration is not saved retentively in the terminal.

It is therefore not necessary to transmit the configuration constantly. That means, bit 15 must not be set constantly.

If bit 15 remains set, the transmitted configuration is compared with the configuration of the terminal in every bus cycle.

The terminal is reconfigured if the configurations are different.

Bits 9 ... 8

Code (bin)	Filter
00	16-sample mean-value (default)
01	No filter
10	4-sample mean-value
11	32-sample mean-value

Bits 5 ... 4

Code	Format
00	IB IL (default setting)
10	S7-compatible
Other	Reserved

See also Section "Measured value representation in the different formats".

Bits 3 ... 0

Code	Measuring range
0000	0 V ... 10 V (default)
0001	±10 V
Other	Reserved

13.2 IN process data

The measured values and diagnostic messages (in the IB IL format) are transmitted channel-by-channel to the PLC via the process data input words IN1 to IN4.

Order of the process data words:

IN1	IN2	IN3	IN4
Channel 1	Channel 2	Channel 3	Channel 4

The measured values are transmitted in the IB IL format or in the S7-compatible format (see Section "Measured value representation in the different formats").

13.3 Read firmware version

OUT1																
Bit	15	14	13	12	11	10	9	8	7	6	5	4	3	2	1	0
Assignment (hex)	3				C				0				0			
Meaning	Read firmware version															

To read the firmware version transmit the value 3C00_{hex} in the output data word OUT1. The words OUT2 ... OUT4 still contain the configuration words for channels 2 to 4.

In response you get the firmware version in input data word IN1. The input data of the associated channels are transmitted in the other input data words.

IN1																
Bit	15	14	13	12	11	10	9	8	7	6	5	4	3	2	1	0
Assignment (hex)	1				2				3				6			
Meaning	Firmware version 1.23												Device ID			

The device ID allows you to distinguish between two devices with the same programming data (ID code, length code).

Inline terminal	ID code	Length code	Device ID
IB IL AI 4/U-PAC	7F _{hex}	04 _{hex}	6
IB IL AI 4/I-PAC	7F _{hex}	04 _{hex}	3

14 Measured value representation in the different formats

14.1 IB IL format

The measured value is represented in bits 14 to 4.

An additional bit (bit 15) is available as a sign bit.

15	14	13	12	11	10	9	8	7	6	5	4	3	2	1	0
SB	Analog value											X	X	X	X

SB Sign bit

X This bit can have the value 0 or 1. The bit is always 0 when a measured value is transmitted. The bit can have the value 1 only when a diagnostic code is transmitted.

Significant measured values

Input data		0 V ... 10 V	± 10 V
hex	dec	SB	SB
8001	Overrange	> 10.837	> 10.837
7F00	32512	10.837	10.837
7530	30000	10.0	10.0
0010	16	0.00533	0.00533
0000	0	≤ 0	≤ 0
FFF0	-16	-	-0.00533
8AD0	-30000	-	-10.0
8100	-32512	-	-10.837
8080	Underrange	-	< -10.837

In the IB IL format a diagnostic code is mapped to the input data in the event of an error.

8001	Measuring range exceeded (overrange)
8004	Measured value invalid/no valid measured value available
8010	Configuration invalid
8020	Faulty supply voltage
8040	Device faulty
8080	Below measuring range (underrange)

14.2 S7-compatible format

The measured value is represented in bits 14 to 4.

An additional bit (bit 15) is available as a sign bit.

15	14	13	12	11	10	9	8	7	6	5	4	3	2	1	0
SB	Analog value											0	0	0	0

SB Sign bit

Significant measured values

Input data		0 V ... 10 V	±10 V
hex	dec	SB	SB
7FFF	Overrange	> 11.754	> 11.754
7EF0	32496	11.754	11.754
6C00	27648	10.0	10.0
0010	16	0.00579	0.00579
0000	0	≤ 0	0
FFF0	-16	-	-0.00579
9400	-27648	-	-10.0
8100	-32512	-	-11.754
8000	Underrange	-	< -11.754

The value 8000_{hex} is specified in S7-compatible format for all errors for which diagnostic codes 8001_{hex} to 8040_{hex} are output in IB IL format.