



Chipsmall Limited consists of a professional team with an average of over 10 year of expertise in the distribution of electronic components. Based in Hongkong, we have already established firm and mutual-benefit business relationships with customers from,Europe,America and south Asia,supplying obsolete and hard-to-find components to meet their specific needs.

With the principle of “Quality Parts,Customers Priority,Honest Operation,and Considerate Service”,our business mainly focus on the distribution of electronic components. Line cards we deal with include Microchip,ALPS,ROHM,Xilinx,Pulse,ON,Everlight and Freescale. Main products comprise IC,Modules,Potentiometer,IC Socket,Relay,Connector.Our parts cover such applications as commercial,industrial, and automotives areas.

We are looking forward to setting up business relationship with you and hope to provide you with the best service and solution. Let us make a better world for our industry!



## Contact us

Tel: +86-755-8981 8866 Fax: +86-755-8427 6832

Email & Skype: info@chipsmall.com Web: www.chipsmall.com

Address: A1208, Overseas Decoration Building, #122 Zhenhua RD., Futian, Shenzhen, China



## Electronic housing - ME 22,5 UTG RD - 2706438

Please be informed that the data shown in this PDF Document is generated from our Online Catalog. Please find the complete data in the user's documentation. Our General Terms of Use for Downloads are valid (<http://download.phoenixcontact.com>)



Lower part of housing closed, fully assembled, with metal foot catch.

Illustration shows fully mounted versions of the electronic housing, in green



### Key commercial data

Packing unit	1 1
Minimum order quantity	10 1
Weight per Piece (excluding packing)	44.0 GRM
Custom tariff number	85472000
Country of origin	Germany

### Classifications

#### eCl@ss

eCl@ss 4.0	27180401
eCl@ss 4.1	27180401
eCl@ss 5.0	27180506
eCl@ss 5.1	27180506
eCl@ss 6.0	27180802
eCl@ss 7.0	27182702
eCl@ss 8.0	27182702

#### ETIM

ETIM 2.0	EC001031
ETIM 3.0	EC001031
ETIM 4.0	EC001031

# Electronic housing - ME 22,5 UTG RD - 2706438

## Classifications

### UNSPSC

UNSPSC 6.01	31261501
UNSPSC 7.0901	31261501
UNSPSC 11	31261501
UNSPSC 12.01	31261501
UNSPSC 13.2	31261501

## Approvals

### Approvals

---

#### Approvals

UL Recognized

---

Ex Approvals

---

Approvals submitted

---

### Approval details

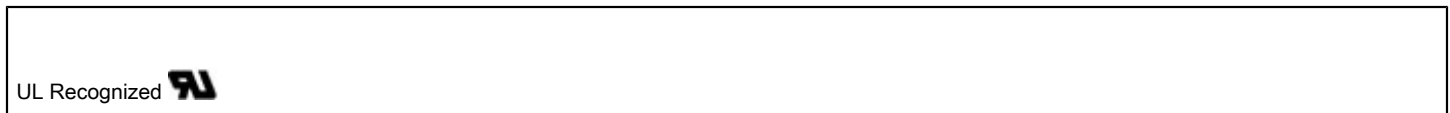

## Accessories

### Accessories

#### Coding element

Coding star - CR-MSTB - 1734401

Coding section, inserted into the recess in the header or the inverted plug, red insulating material



## Electronic housing - ME 22,5 UTG RD - 2706438

### Accessories

Coding profile - CP-MSTB - 1734634

Coding profile, is inserted into the slot on the plug or inverted header, red insulating material



---

### Component housing center part

Electronic housing - ME 45 UTM GN - 2853404



Intermediate element for modular extension of the volume of the housing in the pitch. The open intermediate element is 22.5 mm wide.

---

Electronic housing - ME 45 UTM G GN - 2853417



Intermediate element for modular extension of the volume of the housing in the pitch. The closed intermediate element is 22.5 mm wide.

---

Electronic housing - ME 45 UTM G GN - 2853417



Intermediate element for modular extension of the volume of the housing in the pitch. The closed intermediate element is 22.5 mm wide.

---

### Filler plug

Electronic housing - ME B-22,5 MKDSO GN - 2907143



Filler plugs, for unoccupied terminal points

## Electronic housing - ME 22,5 UTG RD - 2706438

### Accessories

---

#### Ground contact

Electronic housing - ME FE-CONTACT - 2908294



Functional earth ground contact, for intermediate elements.

---

Electronic housing - ME FE-CONTACT - 2908294



Functional earth ground contact, for intermediate elements.

---

#### Mounting material

Components of electronic housing - ME-SAS - 2853899



Shield connection clamp for printed circuit terminal block

---

Electronic housing - ME LPZS - 2906911



PCB stop, for soldering onto PCB

---

## Electronic housing - ME 22,5 UTG RD - 2706438

### Accessories

Electronic housing - ME MF 17,5 - 2908281



Metal foot catch, for intermediate elements.

---

Components of electronic housing - ME-SAS - 2853899



Shield connection clamp for printed circuit terminal block

---

Electronic housing - ME LPZS - 2906911



PCB stop, for soldering onto PCB

---

Electronic housing - ME MF 17,5 - 2908281



Metal foot catch, for intermediate elements.

---

### PCB

Electronic housing - ME LP - 2906908

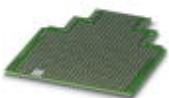

PCB, for custom fitting, with contact to DIN rail (EN 60715)

---

## Electronic housing - ME 22,5 UTG RD - 2706438

### Accessories

Electronic housing - ME LP - 2906908

PCB, for custom fitting, with contact to DIN rail (EN 60715)

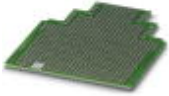

---

### Printed circuit board terminal

Basic terminal block - MKDSO 2,5/ 4-R - 1707247



PCB terminal block, Nominal current: 24 A, Nom. voltage: 400 V, Pitch: 5 mm, Number of positions: 4, Connection method: Screw connection, Mounting: Soldering, Conductor/PCB connection direction: 0 °, Color: green, Article with lateral pin exit

---

Electronic housing - ME B-22,5 MSTBO RD - 2854542

Filler plugs, for unoccupied terminal points

---

Electronic housing - ME B-22,5 MKDSO RD - 2909332

Filler plugs, for unoccupied terminal points

---

PCB terminal block - MKDSO 2,5/ 4-L RD - 2909400

PCB terminal block, Nominal current: 24 A, Nom. voltage: 400 V, Connection method: Screw connection, Mounting: Soldering, Conductor/PCB connection direction: 0 °, Color: red

---

PCB terminal block - MKDSO 2,5/ 4-R RD - 2909413

PCB terminal block, Nominal current: 24 A, Nom. voltage: 400 V, Connection method: Screw connection, Mounting: Soldering, Conductor/PCB connection direction: 0 °, Color: red

---

Electronic housing - ME B-22,5 MKDSO RD - 2909332

## Electronic housing - ME 22,5 UTG RD - 2706438

### Accessories

Filler plugs, for unoccupied terminal points

---

### Required add-on products

Electronic housing - ME 22,5 OT-MSTBO SET - 2907444

Housing upper part, complete with 4 pairs of COMBICON headers and plugs



Electronic housing - ME 22,5 OT-MSTBO GN - 2907169



Upper part of housing, for COMBICON connection, double-level

---

Electronic housing - ME 22,5 OT-1MSTBO GN - 2709558



Upper part of housing, for COMBICON connection, single-level

---

Electronic housing - ME 22,5 OT-MKDSO SET - 2907473

Housing upper part, complete with PCB termination blocks for full equipping. 16-pos., housing width: 22.5 mm





# Electronic housing - ME 22,5 UTG RD - 2706438

## Accessories

Electronic housing - ME 22,5 OT-MKDSO GN - 2907172



Housing upper part, for printed circuit terminal block connection

## Drawings

Dimensioned drawing

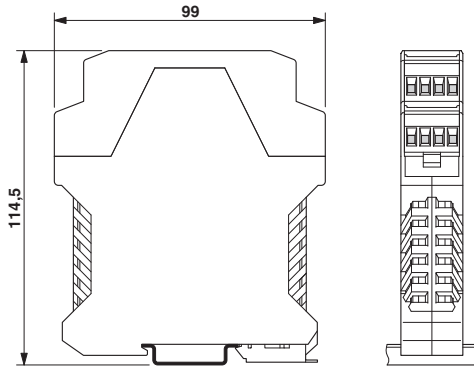

Dimensions of the electronic housing ME... with double-level upper part

Dimensioned drawing

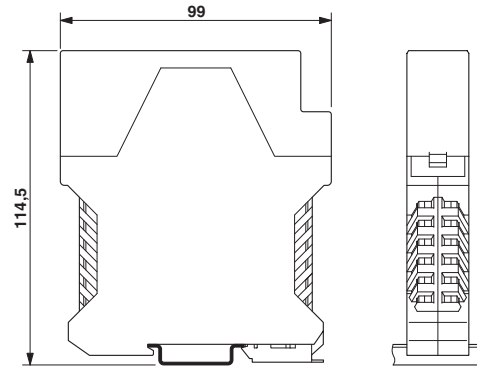

Dimensions of the electronic housing ME... with single-level upper part

Dimensioned drawing

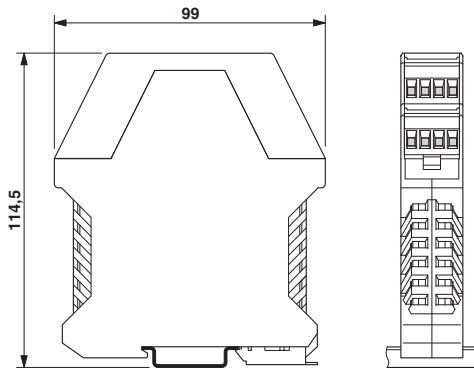

Dimensions of the electronic housing ME... with double-level upper part

Dimensioned drawing

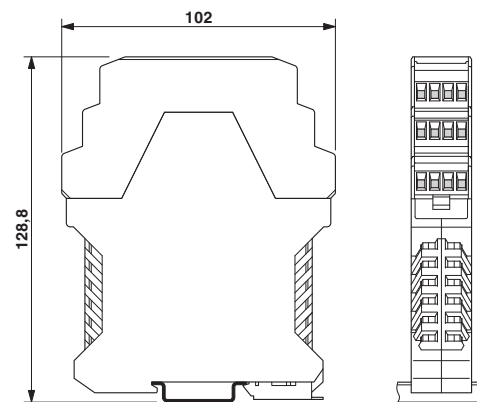

Dimensional drawing of the ME... printed circuit board if the triple-level upper part is used

# Electronic housing - ME 22,5 UTG RD - 2706438

Dimensioned drawing

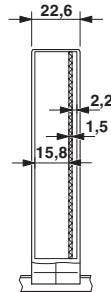

Inner housing dimensions, electronic housing ME 22.5 ...

Dimensioned drawing

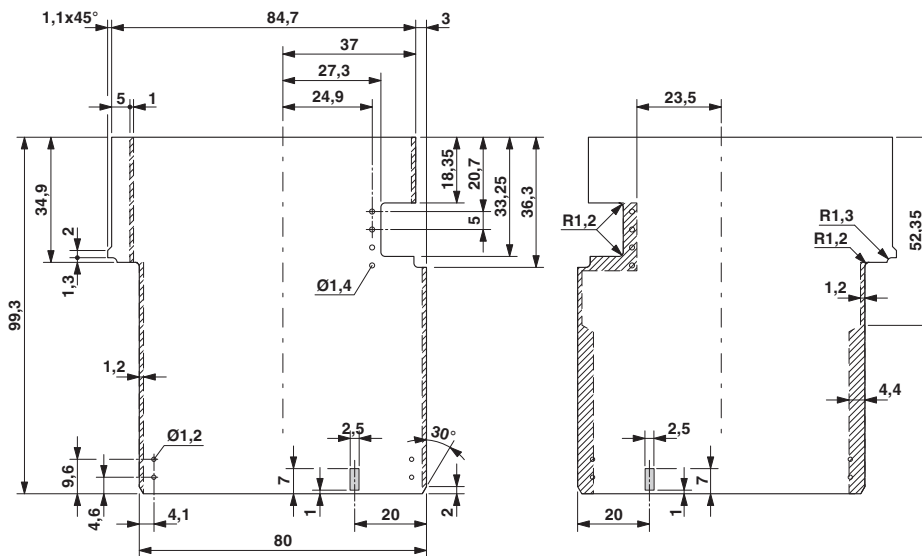

Dimensional drawing of the ME... printed circuit board if the single level upper part is used

# Electronic housing - ME 22,5 UTG RD - 2706438

Dimensioned drawing

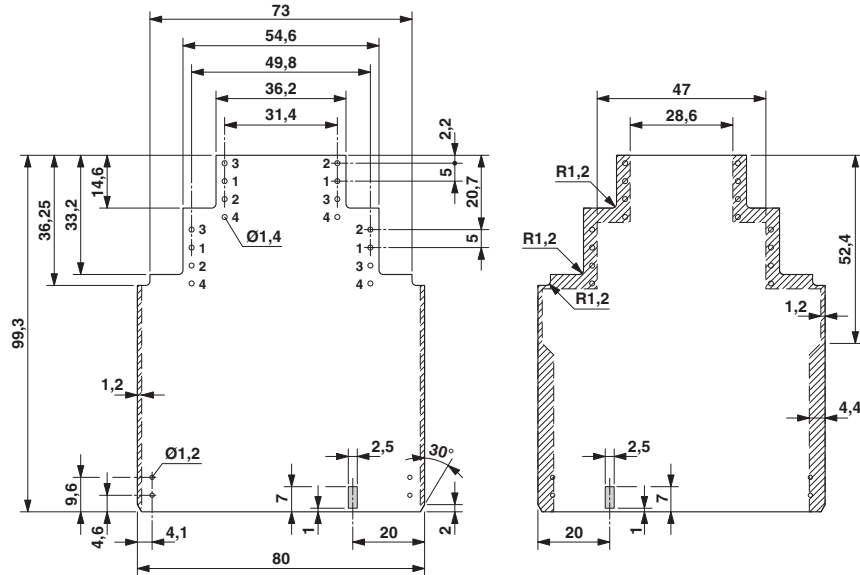

Dimensional drawing of the ME... printed circuit board if the double level upper part is used

Dimensioned drawing

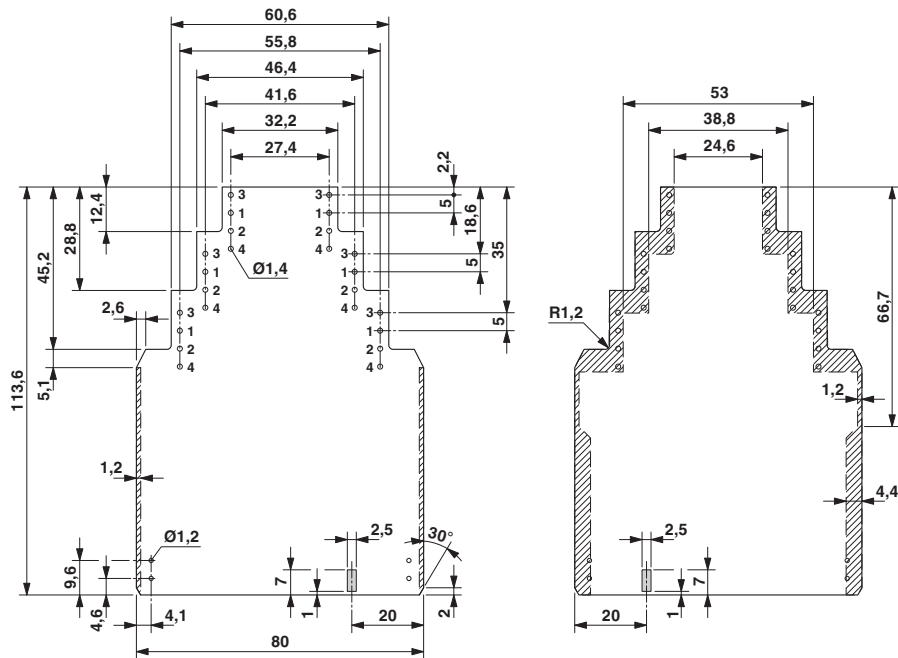

Dimensional drawing of the ME... printed circuit board if the triple-level upper part is used

