



Chipsmall Limited consists of a professional team with an average of over 10 year of expertise in the distribution of electronic components. Based in Hongkong, we have already established firm and mutual-benefit business relationships with customers from,Europe,America and south Asia,supplying obsolete and hard-to-find components to meet their specific needs.

With the principle of “Quality Parts,Customers Priority,Honest Operation,and Considerate Service”,our business mainly focus on the distribution of electronic components. Line cards we deal with include Microchip,ALPS,ROHM,Xilinx,Pulse,ON,Everlight and Freescale. Main products comprise IC,Modules,Potentiometer,IC Socket,Relay,Connector.Our parts cover such applications as commercial,industrial, and automotives areas.

We are looking forward to setting up business relationship with you and hope to provide you with the best service and solution. Let us make a better world for our industry!



Contact us

Tel: +86-755-8981 8866 Fax: +86-755-8427 6832

Email & Skype: info@chipsmall.com Web: www.chipsmall.com

Address: A1208, Overseas Decoration Building, #122 Zhenhua RD., Futian, Shenzhen, China



东莞市欧思科光电科技有限公司

DONGGUANG OPSCO OPTOELECTRONICS CO., LTD

Dongguang Factory : Side of fast in the east, Yucai Road, Dongshan Country, Qishi Town, Dongguan City.
Dongguan Tel: (769)82632725 Dongguan Fax: (769)82632735

SK6812RGBW

SPECIFICATION

INTEGRATED LIGHT SOURCE INTELLIGENT CONTROL OF CHIP-ON-TO P SMD TYPE LED

Document No.: SPC/ SK6812RGBW-XX

Model No.: SK6812RGBW-XX

Description: 5.5x5.0x1.6mm Top SMD Type 0.25 Watt Power
tegrated light source Intelligent control LED

Rev. No.: 01

Date: 2015-07-31

正式规格书



东莞市欧思科光电科技有限公司

DONGGUANG OPSCO OPTOELECTRONICS CO., LTD

Dongguang Factory : Side of fast in the east, Yucai Road, Dongshan Country, Qishi Town, Dongguan City.
Dongguan Tel: (769)82632725 Dongguan Fax: (769)82632735

INTEGRATED LIGHT SOURCE INTELLIGENT CONTROL OF CHIP-ON-TOP SMD TYPE LED

Model: SK6812RGBW

1. Product Overview :

SK6812RGBW is a smart LED control circuit and light emitting circuit in one controlled LED source, which has the shape of a 5050 LED chip. Each lighting element is a pixel, and the intensities of the pixels are contained within the intelligent digital interface input. The output is driven by patented PWM technology, which effectively guarantees high consistency of the color of the pixels. The control circuit consists of a signal shaping amplification circuit, a built-in constant current circuit, and a high precision RC oscillator.

The data protocol being used is unipolar NRZ communication mode. The 32-bit data is transmitted from the controller to DIN of the first element, and if it is accepted it is extracted pixel to pixel. After an internal data latch, the remaining data is passed through the internal amplification circuit and sent out on the DO port to the remaining pixels. The pixel is reset after the end of DIN. Using automatic shaping forwarding technology makes the number of cascaded pixels without signal transmission only limited by signal transmission speed.

The LED has a low driving voltage (which allows for environmental protection and energy saving), high brightness, scattering angle, good consistency, low power, and long life. The control circuit is integrated in the LED above.

2. Main Application Field:

- Full color LED string light, LED full color module, LED super hard and soft lights, LED guardrail tube, LED appearance / scene lighting
- LED point light, LED pixel screen, LED shaped screen, a variety of electronic products, electrical equipment etc..

3. Description:

- Top SMD internal integrated high quality external control line serial cascade constant current IC;
- control circuit and the chip in SMD 5050 components, to form a complete control of pixel, color mixing uniformity and consistency;
- built-in data shaping circuit, a pixel signal is received after wave shaping and output waveform distortion will not guarantee a line;
- The built-in power on reset and reset circuit, the power does not work;
- gray level adjusting circuit (256 level gray scale adjustable);
- red drive special treatment, color balance;
- line data transmission;
- plastic forward strengthening technology, the transmission distance between two points over 10M;
- Using a typical data transmission frequency of 800 Kbps, when the refresh rate of 30 frames per sec

4. Mechanical Dimensions:

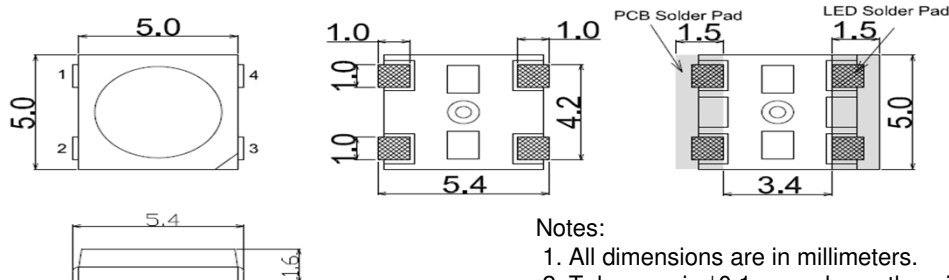

东莞市欧思科光电科技有限公司

DONGGUANG OPSCO OPTOELECTRONICS CO., LTD

Dongguang Factory : Side of fast in the east, Yucai Road, Dongshan Country, Qishi Town, Dongguan City.
Dongguan Tel: (769)82632725 Dongguan Fax: (769)82632735

5. PIN configuration

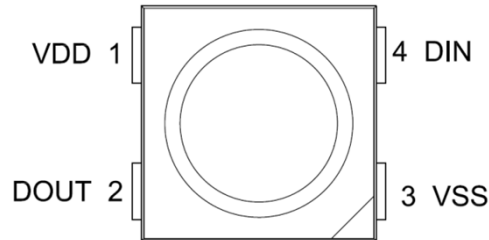

| NO. | Symbol | Function description |
|-----|--------|----------------------------|
| 1 | VDD | Power supply LED |
| 2 | DOUT | Control data signal output |
| 3 | VSS | Ground |
| 4 | DIN | Control data signal input |

6. General Information

SK6812RGBW-XX

SK6812RGBW: The default is the chips with IC integration

R: RED 620-630NM

G: GREEN 515-525 NM

B: BLUE 460-470 NM

W : White Color

-xx BW Blue White 6000-7000K

NW Natural White 4000-4500K

WS Warm Sunlight 2700-3000K

东莞市欧思科光电科技有限公司

DONGGUANG OPSCO OPTOELECTRONICS CO., LTD

Dongguang Factory : Side of fast in the east, Yucai Road, Dongshan Country, Qishi Town, Dongguan City.
Dongguan Tel: (769)82632725 Dongguan Fax: (769)82632735

7. Absolute Maximum Ratings (Ta=25°C, VSS=0V) :

| Parameter | Symbol | Range | Unit |
|----------------------|------------------|--------------|------|
| Power supply voltage | VDD | +3.5~+5.5 | V |
| Logic input voltage | V _{IN} | -0.5~VDD+0.5 | V |
| Working temperature | Topt | -40~+85 | °C |
| Storage temperature | Tstg | -50~+150 | °C |
| ESD pressure | V _{ESD} | 4K | V |

8. The electrical parameters (unless otherwise specified, TA=-20 ~ +70 °C, VDD=4.5 ~ 5.5V, VSS=0V):

| Parameter | Symbol | Min | Typical | Max | Unit | Test conditions |
|---------------------------------|---------|-----|---------|-----|------|--|
| The chip supply voltage | VDD | --- | 5.2 | --- | V | --- |
| R/G/B port pressure | VDS,MAX | --- | --- | 26 | V | --- |
| DOUT drive capability | IDOH | --- | 49 | --- | mA | DOUT connect ground, the maximum drive current |
| | IDOL | --- | -50 | --- | mA | DOUT connect +, the largest current |
| The signal input flip threshold | VIH | 3.4 | --- | --- | V | VDD=5.0V |
| | VIL | --- | --- | 1.6 | V | |
| The frequency of PWM | FPWM | --- | 1.2 | --- | KHZ | --- |
| Static power consumption | IDD | --- | 1 | --- | mA | --- |

9. The dynamic parameters (Ta=25 °C):

| Parameter | Symbol | Min | Typical | Max | Unit | Test conditions |
|--------------------------------|--------|-----|---------|-----|------|--------------------------------|
| The speed of data transmission | fDIN | --- | 800 | --- | KHZ | The duty ratio of 67% (data 1) |
| DOUT transmission delay | TPLH | --- | --- | 500 | ns | DIN→DOUT |
| | TPHL | --- | --- | 500 | ns | |
| IOUT Rise/Drop Time | Tr | --- | --- | 40 | ns | VDS=1.5 IOUT=9mA |
| | Tf | --- | --- | 80 | ns | |

东莞市欧思科光电科技有限公司

DONGGUANG OPSCO OPTOELECTRONICS CO., LTD

Dongguang Factory : Side of fast in the east, Yucai Road, Dongshan Country, Qishi Town, Dongguan City.
 Dongguan Tel: (769)82632725 Dongguan Fax: (769)82632735

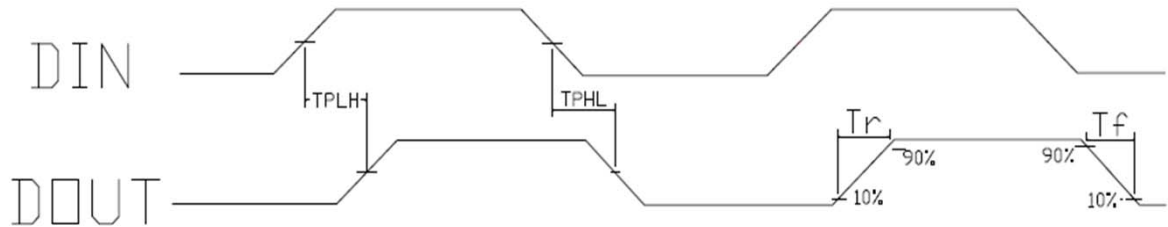

10. The data transmission time ($T_H+T_L=1.25\mu s\pm 600ns$):

| | | | |
|------|----------------------------|-------------|-----------------|
| T0H | 0 code, high level time | 0.3 μs | $\pm 0.15\mu s$ |
| T0L | 0 code, low level time | 0.9 μs | $\pm 0.15\mu s$ |
| T1H | 1 code, high level time | 0.6 μs | $\pm 0.15\mu s$ |
| T1L | 1 code, low level time | 0.6 μs | $\pm 0.15\mu s$ |
| Trst | Reset code, low level time | 80 μs | |

11. Timing waveform:

Input code:

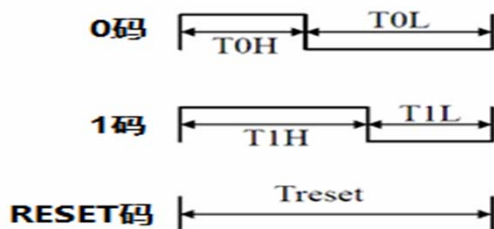

Connection mode:

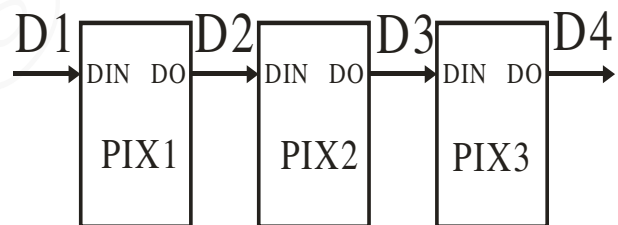

12. The method of data transmission:

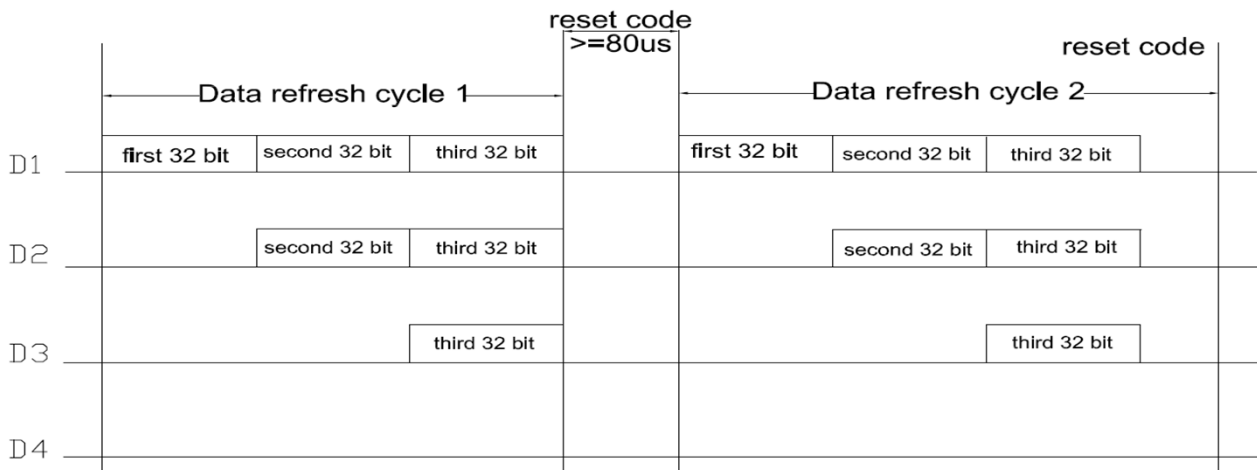

Note: the D1 sends data for MCU, D2, D3, D4 for data forwarding automatic shaping cascade circuit.

东莞市欧思科光电科技有限公司

DONGGUANG OPSCO OPTOELECTRONICS CO., LTD

Dongguang Factory : Side of fast in the east, Yucai Road, Dongshan Country, Qishi Town, Dongguan City.
 Dongguan Tel: (769)82632725 Dongguan Fax: (769)82632735

13. The data structure of 32bit:

| | | | | | | | | | | | |
|----|----|----|----|----|----|----|----|----|----|----|----|
| R7 | R6 | R5 | R4 | R3 | R2 | R1 | R0 | G7 | G6 | G5 | G4 |
| G3 | G2 | G1 | G0 | B7 | B6 | B5 | B4 | B3 | B2 | B1 | B0 |
| W7 | W6 | W5 | W4 | W3 | W2 | W1 | W0 | | | | |

Note: high starting, in order to send data (R7 - R6 - W0)

14. The typical application circuit:

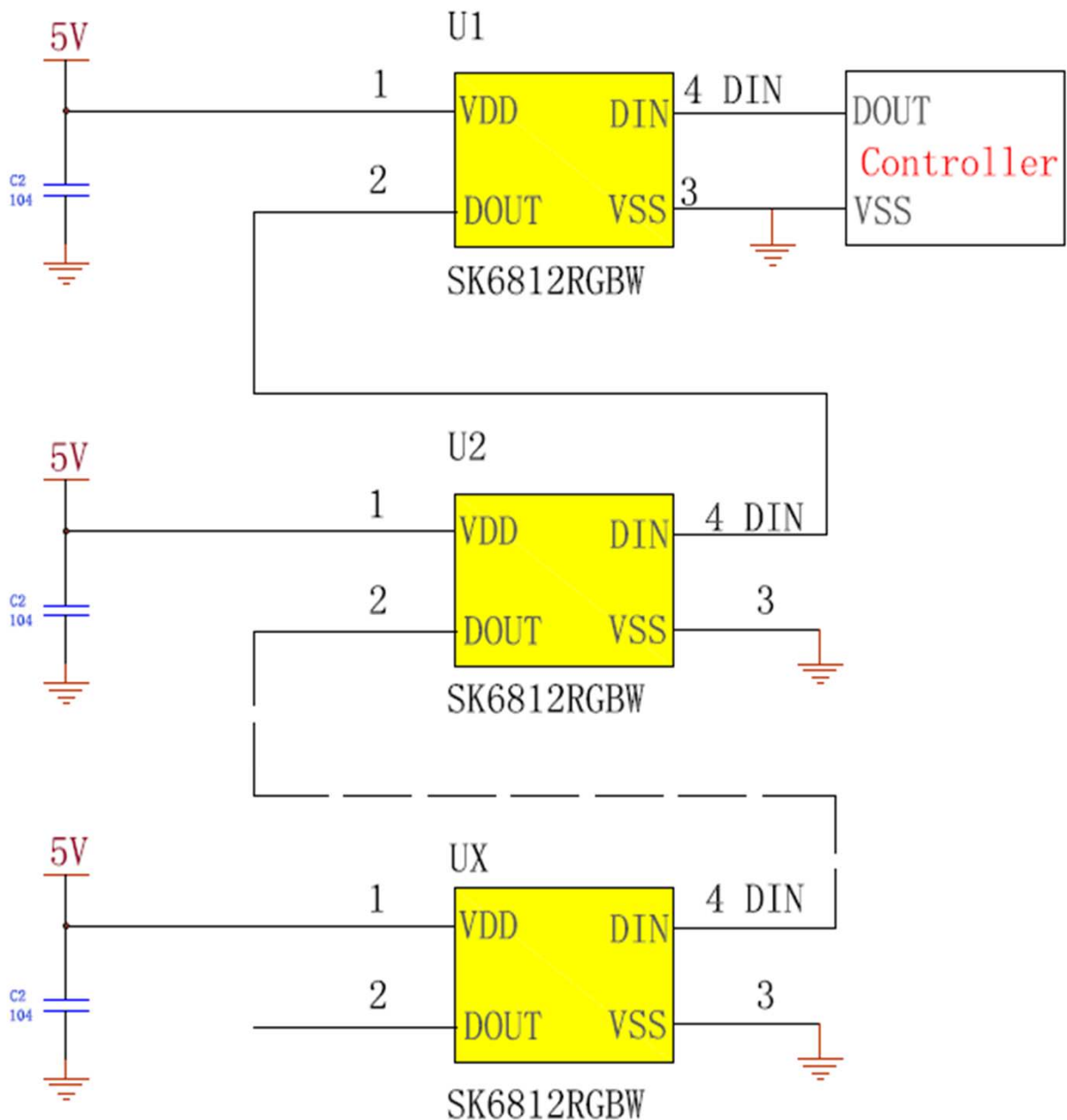

东莞市欧思科光电科技有限公司

DONGGUANG OPSCO OPTOELECTRONICS CO., LTD

Dongguang Factory : Side of fast in the east, Yucai Road, Dongshan Country, Qishi Town, Dongguan City.
 Dongguan Tel: (769)82632725 Dongguan Fax: (769)82632735

15. White Color Temperature Ranks & CIE Color Rank (Refer to CIE 1931 chromaticity diagram)

CIE chromaticity coordinates (ANSI Cool White)

| C. A | X | Y | C. A | X | Y | C. A | X | Y | C. A | X | Y |
|------|--------|--------|------|--------|--------|------|--------|--------|------|--------|--------|
| C1 | 0.3048 | 0.3207 | C2 | 0.3028 | 0.3304 | C3 | 0.3115 | 0.3391 | C4 | 0.3130 | 0.3290 |
| | 0.3130 | 0.3290 | | 0.3115 | 0.3391 | | 0.3205 | 0.3481 | | 0.3213 | 0.3373 |
| | 0.3144 | 0.3186 | | 0.3130 | 0.3290 | | 0.3213 | 0.3373 | | 0.3144 | 0.3186 |
| | 0.3068 | 0.3113 | | 0.3048 | 0.3207 | | 0.3130 | 0.3290 | | 0.3144 | 0.3186 |
| C5 | 0.3068 | 0.3113 | C6 | 0.3005 | 0.3415 | C7 | 0.3099 | 0.3509 | C8 | 0.3144 | 0.3186 |
| | 0.3144 | 0.3186 | | 0.3099 | 0.3509 | | 0.3196 | 0.3602 | | 0.3221 | 0.3261 |
| | 0.3161 | 0.3059 | | 0.3115 | 0.3391 | | 0.3205 | 0.3481 | | 0.3231 | 0.3120 |
| | 0.3093 | 0.2993 | | 0.3028 | 0.3304 | | 0.3115 | 0.3391 | | 0.3161 | 0.3059 |
| D1 | 0.3215 | 0.3350 | D2 | 0.3207 | 0.3462 | D3 | 0.3290 | 0.3538 | D4 | 0.3290 | 0.3417 |
| | 0.3290 | 0.3417 | | 0.3290 | 0.3538 | | 0.3376 | 0.3616 | | 0.3371 | 0.3490 |
| | 0.3290 | 0.3300 | | 0.3290 | 0.3417 | | 0.3371 | 0.3490 | | 0.3290 | 0.3417 |
| | 0.3222 | 0.3243 | | 0.3215 | 0.3350 | | 0.3290 | 0.3417 | | 0.3290 | 0.3417 |
| D5 | 0.3222 | 0.3243 | D6 | 0.3196 | 0.3602 | D7 | 0.3290 | 0.3690 | D8 | 0.3290 | 0.3300 |
| | 0.3290 | 0.3300 | | 0.3290 | 0.3690 | | 0.3381 | 0.3762 | | 0.3366 | 0.3369 |
| | 0.3290 | 0.3180 | | 0.3290 | 0.3538 | | 0.3376 | 0.3616 | | 0.3361 | 0.3245 |
| | 0.3231 | 0.3120 | | 0.3207 | 0.3462 | | 0.3290 | 0.3538 | | 0.3290 | 0.3180 |
| E1 | 0.3371 | 0.3490 | E2 | 0.3376 | 0.3616 | E3 | 0.3463 | 0.3687 | E4 | 0.3451 | 0.3554 |
| | 0.3451 | 0.3554 | | 0.3463 | 0.3687 | | 0.3551 | 0.3760 | | 0.3533 | 0.3620 |
| | 0.3440 | 0.3427 | | 0.3451 | 0.3554 | | 0.3533 | 0.3620 | | 0.3451 | 0.3554 |
| | 0.3366 | 0.3369 | | 0.3371 | 0.3490 | | 0.3451 | 0.3554 | | 0.3440 | 0.3427 |
| E5 | 0.3366 | 0.3369 | E6 | 0.3381 | 0.3762 | E7 | 0.3480 | 0.3840 | E8 | 0.3440 | 0.3428 |
| | 0.3440 | 0.3428 | | 0.3480 | 0.3840 | | 0.3571 | 0.3907 | | 0.3515 | 0.3487 |
| | 0.3429 | 0.3307 | | 0.3463 | 0.3687 | | 0.3551 | 0.3760 | | 0.3495 | 0.3339 |
| | 0.3361 | 0.3245 | | 0.3376 | 0.3616 | | 0.3463 | 0.3687 | | 0.3429 | 0.3307 |

ANSI Blue White Color bin structures

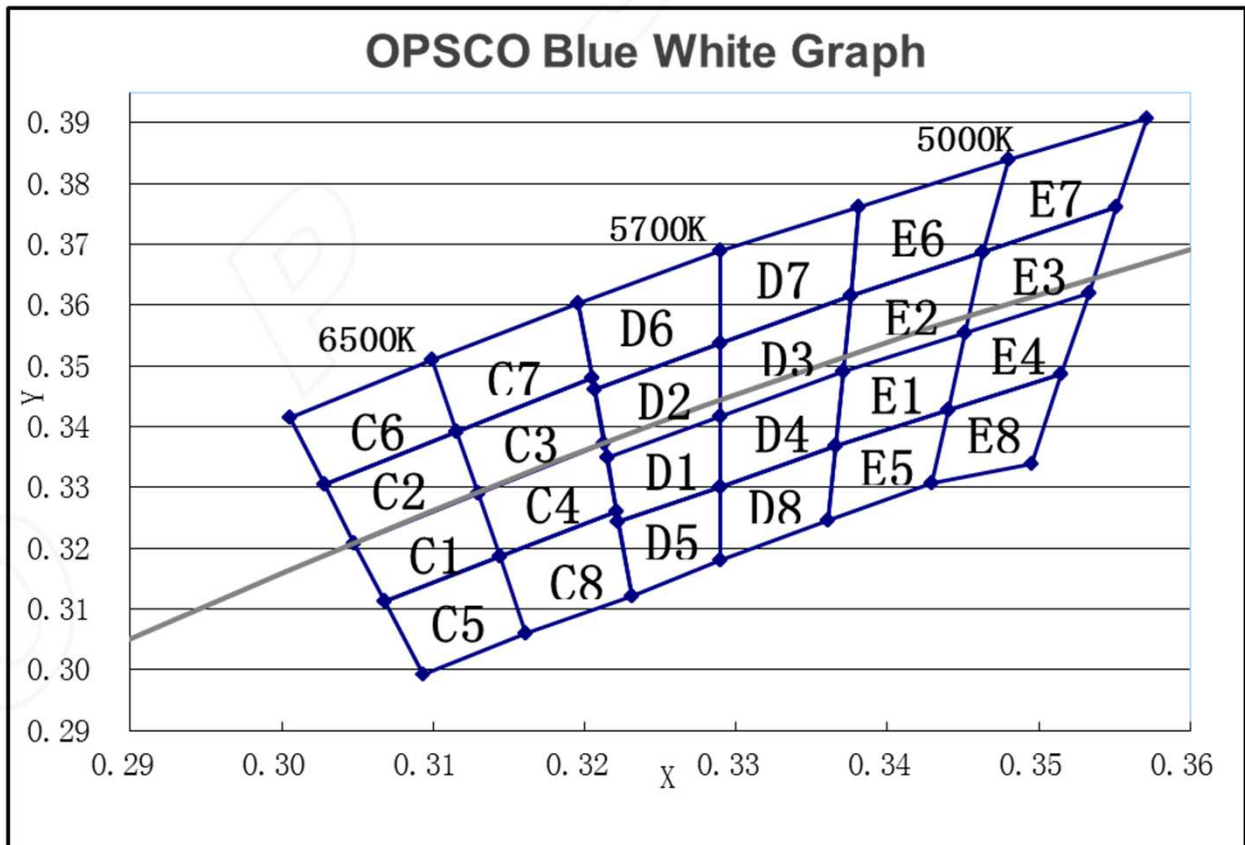

东莞市欧思科光电科技有限公司

DONGGUANG OPSCO OPTOELECTRONICS CO., LTD

Dongguang Factory : Side of fast in the east, Yucai Road, Dongshan Country, Qishi Town, Dongguan City.
 Dongguan Tel: (769)82632725 Dongguan Fax: (769)82632735

CIE chromaticity coordinates (ANSI Natural white)

| C.A | X | Y | C.A | X | Y | C.A | X | Y | C.A | X | Y |
|-----|--------|--------|-----|--------|--------|-----|--------|--------|-----|--------|--------|
| F1 | 0.3530 | 0.3597 | F2 | 0.3548 | 0.3736 | F3 | 0.3641 | 0.3804 | F4 | 0.3615 | 0.3659 |
| | 0.3615 | 0.3659 | | 0.3641 | 0.3804 | | 0.3736 | 0.3874 | | 0.3702 | 0.3722 |
| | 0.3590 | 0.3521 | | 0.3615 | 0.3659 | | 0.3702 | 0.3722 | | 0.3670 | 0.3578 |
| | 0.3512 | 0.3465 | | 0.3530 | 0.3597 | | 0.3615 | 0.3659 | | 0.3590 | 0.3521 |
| F5 | 0.3512 | 0.3465 | F6 | 0.3571 | 0.3907 | F7 | 0.3668 | 0.3957 | F8 | 0.359 | 0.3521 |
| | 0.359 | 0.3521 | | 0.3668 | 0.3957 | | 0.3771 | 0.4034 | | 0.367 | 0.3578 |
| | 0.3567 | 0.3389 | | 0.3641 | 0.3804 | | 0.3736 | 0.3874 | | 0.364 | 0.344 |
| | 0.3495 | 0.3339 | | 0.3548 | 0.3736 | | 0.3641 | 0.3804 | | 0.3567 | 0.3389 |
| G1 | 0.367 | 0.3578 | G2 | 0.3702 | 0.3722 | G3 | 0.3825 | 0.3798 | G4 | 0.3783 | 0.3646 |
| | 0.3702 | 0.3722 | | 0.3736 | 0.3874 | | 0.3869 | 0.3958 | | 0.3825 | 0.3798 |
| | 0.3825 | 0.3798 | | 0.3869 | 0.3958 | | 0.4006 | 0.4044 | | 0.395 | 0.3875 |
| | 0.3783 | 0.3646 | | 0.3825 | 0.3798 | | 0.395 | 0.3875 | | 0.3898 | 0.3716 |
| G5 | 0.367 | 0.3578 | G6 | 0.3771 | 0.4034 | G7 | 0.3916 | 0.4127 | G8 | 0.3783 | 0.3646 |
| | 0.3783 | 0.3646 | | 0.3916 | 0.4127 | | 0.4064 | 0.4221 | | 0.3898 | 0.3716 |
| | 0.3743 | 0.3502 | | 0.3869 | 0.3958 | | 0.4006 | 0.4044 | | 0.3848 | 0.3565 |
| | 0.364 | 0.344 | | 0.3736 | 0.3874 | | 0.3869 | 0.3958 | | 0.3743 | 0.3502 |
| H6 | 0.4054 | 0.4191 | H2 | 0.3941 | 0.3848 | H1 | 0.3889 | 0.369 | H5 | 0.3889 | 0.369 |
| | 0.4217 | 0.4273 | | 0.3996 | 0.4015 | | 0.3941 | 0.3848 | | 0.4017 | 0.3751 |
| | 0.4146 | 0.4089 | | 0.4146 | 0.4089 | | 0.408 | 0.3916 | | 0.3957 | 0.3596 |
| | 0.3996 | 0.4015 | | 0.408 | 0.3916 | | 0.4017 | 0.3751 | | 0.384 | 0.354 |

ANSI Natural White Color bin structures

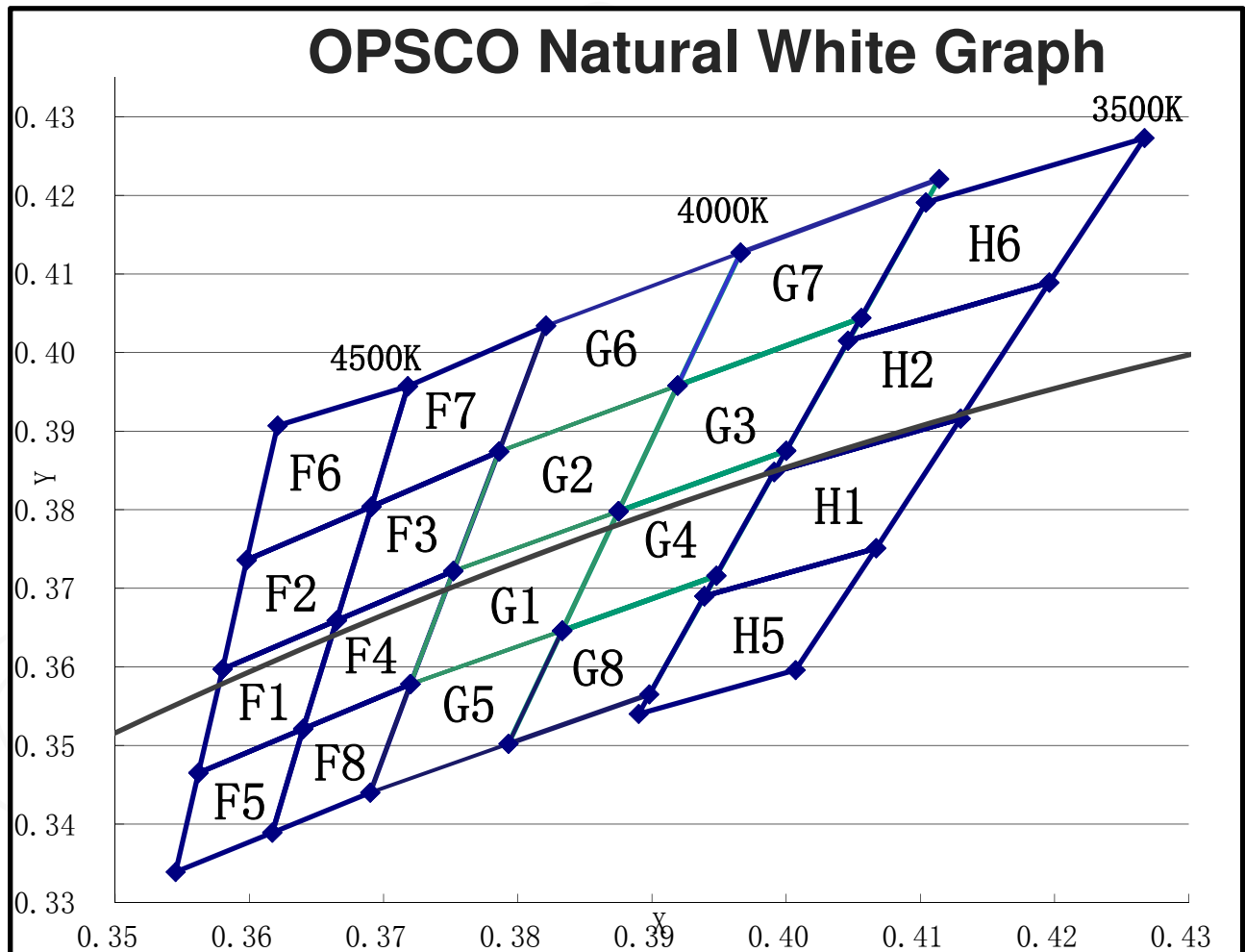

东莞市欧思科光电科技有限公司

DONGGUANG OPSCO OPTOELECTRONICS CO., LTD

Dongguang Factory : Side of fast in the east, Yucai Road, Dongshan Country, Qishi Town, Dongguan City.
 Dongguan Tel: (769)82632725 Dongguan Fax: (769)82632735

CIE chromaticity coordinates (ANSI Warm White)

| C. A | X | Y | C. A | X | Y | C. A | X | Y | C. A | X | Y | | |
|------|--------|--------|------|--------|--------|------|--------|--------|------|--------|--------|--------|--------|
| H1 | 0.4082 | 0.3922 | H2 | 0.4146 | 0.4089 | H3 | 0.4299 | 0.4165 | H4 | 0.4221 | 0.3984 | | |
| | 0.3941 | 0.3848 | | 0.3996 | 0.4015 | | 0.4146 | 0.4089 | | 0.4082 | 0.3922 | 0.4017 | 0.3752 |
| | 0.3889 | 0.3690 | | 0.3941 | 0.3848 | | 0.4082 | 0.3922 | | 0.4221 | 0.3984 | 0.4147 | 0.3814 |
| | 0.4017 | 0.3752 | | 0.4082 | 0.3922 | | 0.4562 | 0.4260 | | 0.4430 | 0.4212 | 0.4465 | 0.4071 |
| K1 | 0.4344 | 0.4032 | K2 | 0.4430 | 0.4212 | K3 | 0.4562 | 0.4260 | K4 | 0.4465 | 0.4071 | | |
| | 0.4221 | 0.3984 | | 0.4299 | 0.4165 | | 0.4430 | 0.4212 | | 0.4344 | 0.4032 | 0.4260 | 0.3853 |
| | 0.4147 | 0.3814 | | 0.4221 | 0.3984 | | 0.4344 | 0.4032 | | 0.4465 | 0.4071 | 0.4373 | 0.3893 |
| | 0.4260 | 0.3853 | | 0.4344 | 0.4032 | | 0.4813 | 0.4319 | | 0.4687 | 0.4289 | 0.4700 | 0.4126 |
| L1 | 0.4586 | 0.4103 | L2 | 0.4687 | 0.4289 | L3 | 0.4813 | 0.4319 | L4 | 0.4586 | 0.4103 | | |
| | 0.4465 | 0.4071 | | 0.4562 | 0.4260 | | 0.4687 | 0.4289 | | 0.4586 | 0.4103 | 0.4593 | 0.3944 |
| | 0.4373 | 0.3893 | | 0.4465 | 0.4071 | | 0.4586 | 0.4103 | | 0.4700 | 0.4126 | 0.4586 | 0.4103 |
| | 0.4483 | 0.3918 | | 0.4586 | 0.4103 | | 0.4700 | 0.4126 | | 0.4593 | 0.3944 | 0.4483 | 0.3918 |

ANSI Warm White Color bin structures

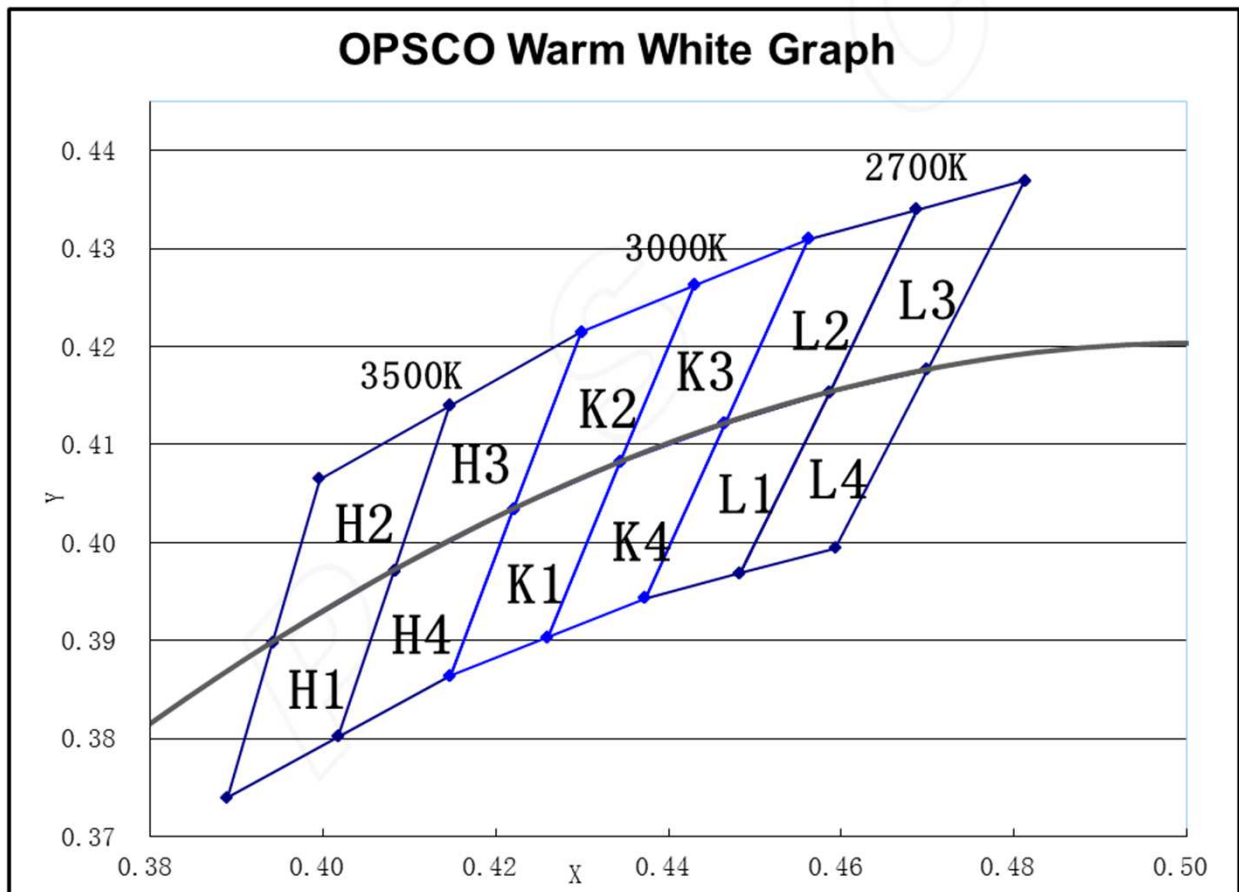

东莞市欧思科光电科技有限公司

DONGGUANG OPSCO OPTOELECTRONICS CO., LTD

Dongguang Factory : Side of fast in the east, Yucai Road, Dongshan Country, Qishi Town, Dongguan City.
 Dongguan Tel: (769)82632725 Dongguan Fax: (769)82632735

16. Standard LED Performance Graph:

Typical Relative Luminous Flux vs. Forward Current

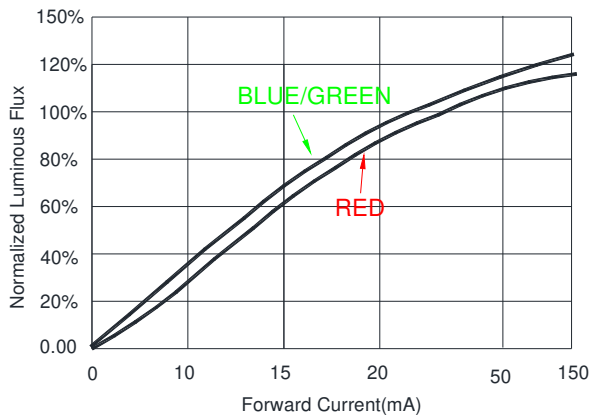

Forward Voltage vs. Forward Current

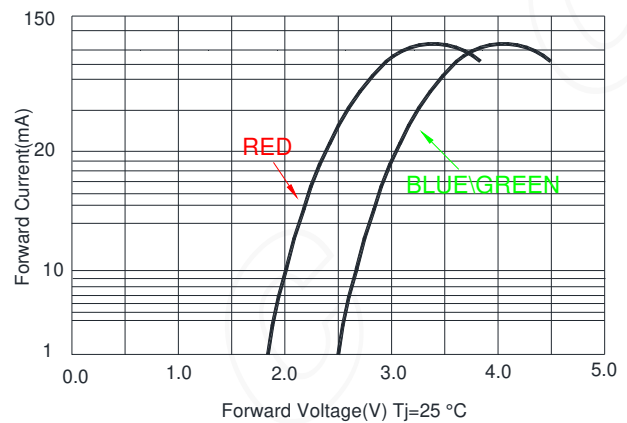

Thermal Pad Temperature vs. Relative Light Output

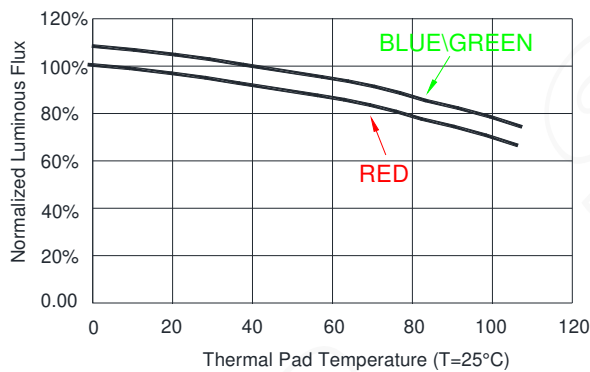

Wavelength Characteristics

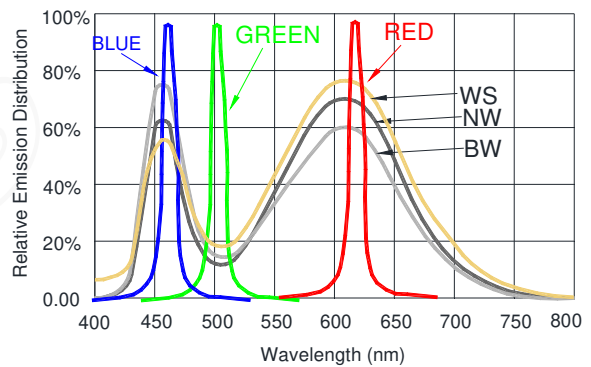

Thermal Pad Temperature vs. Forward Current

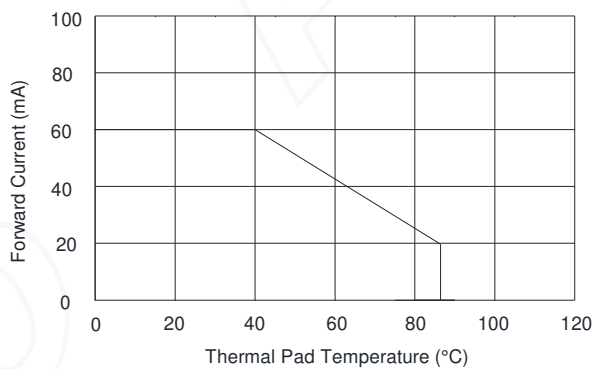

Typical Radiation Pattern 120°

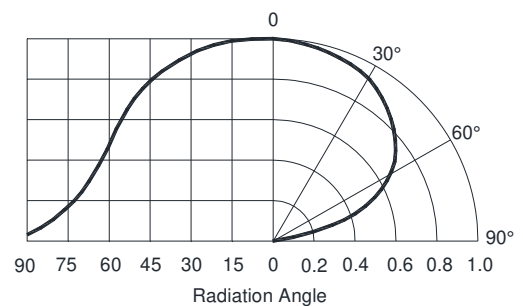

东莞市欧思科光电科技有限公司

DONGGUANG OPSCO OPTOELECTRONICS CO., LTD

Dongguang Factory : Side of fast in the east, Yucai Road, Dongshan Country, Qishi Town, Dongguan City.
Dongguan Tel: (769)82632725 Dongguan Fax: (769)82632735

17. Packaging Standard:

SK6812RGBW-XX

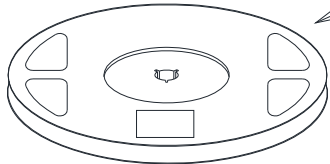
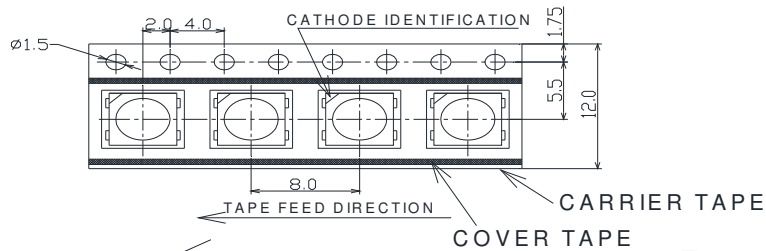

REEL(178x12mm)
(INNER 1000pcs LED MAX)

ESD POLYETHYLENE BAG

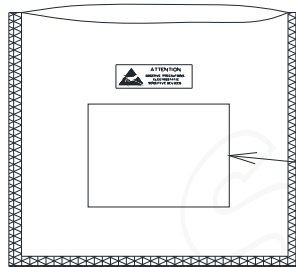

LABEL SKETCHING

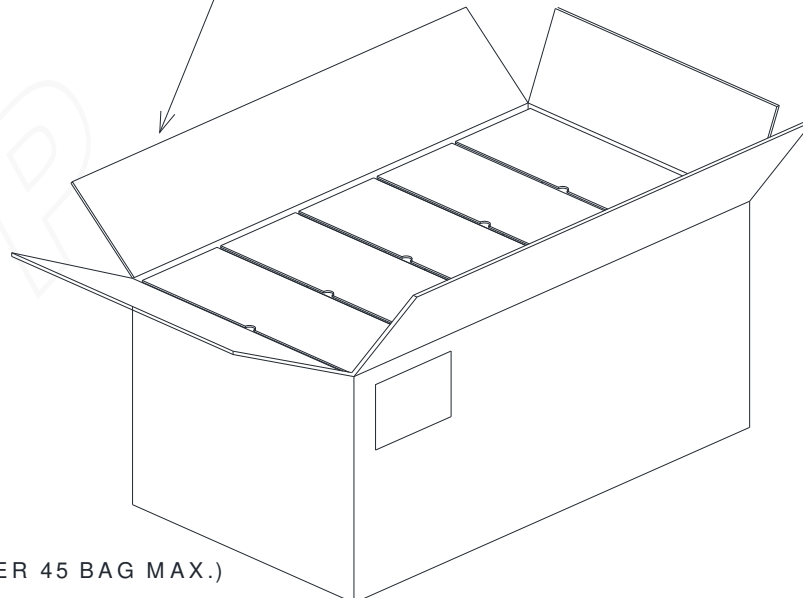

CARDBOARD (INNER 45 BAG MAX.)

The reel pack is applied in SMD LED. The LEDs are packed in cardboard boxes after packaging in normal or anti-electrostatic bags. cardboard boxes will be used to protect the LEDs from mechanical shocks during transportation. The boxes are not water resistant and therefore must be kept away from water and moisture.

东莞市欧思科光电科技有限公司

DONGGUANG OPSCO OPTOELECTRONICS CO., LTD

Dongguang Factory : Side of fast in the east, Yucai Road, Dongshan Country, Qishi Town, Dongguan City.
Dongguan Tel: (769)82632725 Dongguan Fax: (769)82632735

TOP SMD LED Application Notes

1. Features

The Purposes of making OPSCO's customers and users to have a clear understanding on the ways how to use the LED.

2. Description

Generally, The LED can be used the same way as other general purposed semiconductors. When using OPSCO's TOP SMD LED, the following precautions must be taken to protect the LED.

3. Cautions

3.1. Dust & Cleaning

This emitter has a silicone surface, There are many benefits to the silicone surface in terms of optical properties and improved reliability. However, silicone is a softer material and prone to attract dust. While a minimal amount of dust and debris on the LED will not cause significant reduction in illumination, steps should be taken to keep the emitter free of dust.

These include keeping the LEDs in the manufacturer's package prior to assembly and storing assemblies in an enclosed area after installing the emitters.

Surface condition of this device may change when organic solvents such as trichloroethylene or acetone were applied.

Avoid using organic solvent, it is recommended that isopropyl be used as a solvent for cleaning the LEDs. When using other solvents, it should be confirmed beforehand whether the solvents will dissolve the package and the resin or not.

Do not clean the LEDs by the ultrasonic. When it is absolutely necessary, the influence as ultrasonic cleaning on the LEDs depends on factors such as ultrasonic power. Baking time and assembled condition. Before cleaning, a pre-test should be done to confirm whether any damage to the LEDs will occur.

3.2. Moisture Proof Package

In order to avoid the absorption of moisture during transportation and storage, LED are packed in the aluminum envelop, A desiccant is included in the aluminum envelop as it absorbs moisture. When moisture is absorbed into the AMT package it may vaporize and expand during soldering. There is a possibility that this can cause exfoliation of the contacts and damage to the optical characteristics of the LEDs. For this reason, the moisture proof package is used to keep moisture to a minimum in the package.

3.3. Storage

In order to avoid the absorption of moisture, It is recommended to store SMD LED (in bulk or taped) in the dry box (or the desiccator) with a desiccant, Otherwise to store them in the following environment as recommended.

a. Temperature: 5°C~30°C

b. Humidity: 60% RH Max

It is recommended to solder the LED as soon as possible after unpacking the aluminum envelop, But in case that the LED have to be left unused after unpacking envelop again is requested.

The LED should be soldering within 1 hours after opening the package.

If baking is required, A baking treatment should be performed as follows:

70°C±5°C for more than 24 hours.

东莞市欧思科光电科技有限公司

DONGGUANG OPSCO OPTOELECTRONICS CO., LTD

Dongguang Factory : Side of fast in the east, Yucai Road, Dongshan Country, Qishi Town, Dongguan City.
 Dongguan Tel: (769)82632725 Dongguan Fax: (769)82632735

3.4. Reflow Soldering Characteristics

In testing, OPSCO has found S50 LEDs to be compatible with JEDEC J-STD-020C, using the parameters listed below. As a general guideline OPSCO recommends that users follow the recommended soldering profile provided by the manufacturer of solder paste used.

Note that this general guideline is offered as a starting point and may require adjustment for certain PCB designs and Configurations of reflow soldering equipment.

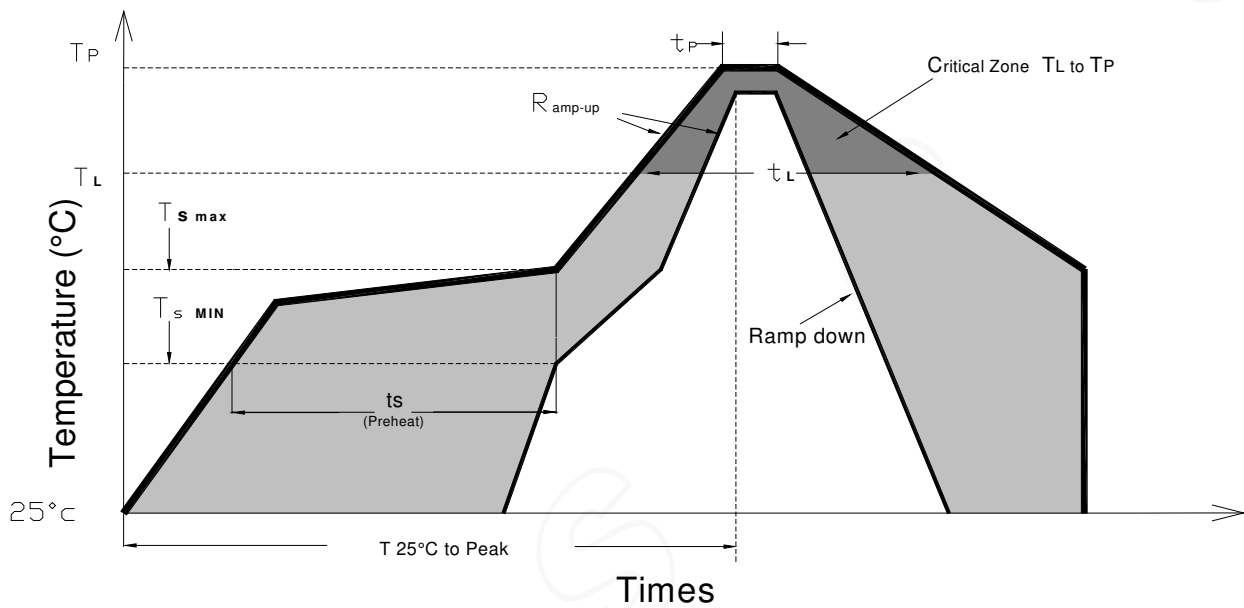

| Profile Feature | Lead-Based Solder | Lead-Free Solder |
|--|-------------------|------------------|
| Average Ramp-Up Rate ($T_{S\ max}$ to T_p) | 3°C/second max. | 3°C/second max. |
| Preheat: Temperature Min ($T_{s\ min}$) | 100°C | 150°C |
| Preheat: Temperature Min ($T_{s\ max}$) | 150°C | 200°C |
| Preheat: Time ($t_{s\ min}$ to $t_{s\ max}$) | 60-120 seconds | 60-180 seconds |
| Time Maintained Above: Temperature (T_L) | 183 °C | 217 °C |
| Time Maintained Above: Time (t_L) | 60-150 seconds | 60-150 seconds |
| Peak/Classification Temperature (T_p) | 215 °C | 255 °C |
| Time Within 5°C of Actual Peak Temperature (t_p) | <10 seconds | <10 seconds |
| Ramp-Down Rate | 6°C/second max. | 6°C/second max. |
| Time 25 °C to Peak Temperature | <6 minutes max. | <6 minutes max. |

Note: All temperatures refer to topside of the package, measured on the package body surface.

东莞市欧思科光电科技有限公司

DONGGUANG OPSCO OPTOELECTRONICS CO., LTD

Dongguang Factory : Side of fast in the east, Yucai Road, Dongshan Country, Qishi Town, Dongguan City.
Dongguan Tel: (769)82632725 Dongguan Fax: (769)82632735

3.5 Heat Generation:

Thermal design of the end product is of paramount importance. Please consider the heat generation of the LED when making the system design. The coefficient of temperature increase per input electric power is affected by the thermal resistance of the circuit board and density of LED placement on the board, as well as components. It is necessary to avoid in tense heat generation and operate within the maximum rating given in this specification. The operating current should be decided after considering the ambient maximum temperature of LEDs

3.6 Electrostatic Discharge & Surge Current :

Electrostatic discharge (ESD) or surge current (EOS) may damage LED.

Precautions such as ESD wrist strap, ESD shoe strap or antistatic gloves must be worn whenever handling of LED.

All devices, equipment and machinery must be properly grounded.

It is recommended to perform electrical test to screen out ESD failures at final inspection.

It is important to eliminate the possibility of surge current during circuitry design.

3.7 Moisture Proof Package

Cannot take any responsibility for any trouble that are caused by using the LEDs at conditions exceeding our specifications.

The LED light output is strong enough to injure human eyes. Precautions must be taken to prevent looking directly at the LEDs with unaided eyes for more than a few seconds.

The formal specification must be exchanged and signed by both parties before large volume purchase begins.

The appearance and specifications of the product may be modified for improvement without notice.

东莞市欧思科光电科技有限公司

DONGGUANG OPSCO OPTOELECTRONICS CO., LTD

Dongguang Factory : Side of fast in the east, Yucai Road, Dongshan Country, Qishi Town, Dongguan City.
Dongguan Tel: (769)82632725 Dongguan Fax: (769)82632735

Change History

| FCN No. | Date | Rev. No. | Changes/Reason of changes |
|---------|------------|----------|---------------------------|
| | 2015-07-31 | 01 | Initial Document |
| | | | |
| | | | |
| | | | |
| | | | |
| | | | |
| | | | |
| | | | |
| | | | |
| | | | |
| | | | |
| | | | |
| | | | |
| | | | |
| | | | |
| | | | |
| | | | |
| | | | |
| | | | |
| | | | |
| | | | |
| | | | |
| | | | |

| Items | Signatures | Date | Note |
|-------------|------------|------------|------|
| Prepared by | Kevin Zhu | 2015-07-31 | |
| Checked by | | | |
| Approved by | | | |
| FCN# | | | |