



Chipsmall Limited consists of a professional team with an average of over 10 year of expertise in the distribution of electronic components. Based in Hongkong, we have already established firm and mutual-benefit business relationships with customers from,Europe,America and south Asia,supplying obsolete and hard-to-find components to meet their specific needs.

With the principle of “Quality Parts,Customers Priority,Honest Operation,and Considerate Service”,our business mainly focus on the distribution of electronic components. Line cards we deal with include Microchip,ALPS,ROHM,Xilinx,Pulse,ON,Everlight and Freescale. Main products comprise IC,Modules,Potentiometer,IC Socket,Relay,Connector.Our parts cover such applications as commercial,industrial, and automotives areas.

We are looking forward to setting up business relationship with you and hope to provide you with the best service and solution. Let us make a better world for our industry!



Contact us

Tel: +86-755-8981 8866 Fax: +86-755-8427 6832

Email & Skype: info@chipsmall.com Web: www.chipsmall.com

Address: A1208, Overseas Decoration Building, #122 Zhenhua RD., Futian, Shenzhen, China



Thermomagnetic device circuit breaker - CB TM1 0.5A SFB P - 2800835

Please be informed that the data shown in this PDF Document is generated from our Online Catalog. Please find the complete data in the user's documentation. Our General Terms of Use for Downloads are valid (<http://download.phoenixcontact.com>)



Thermomagnetic device circuit breaker, 1-pos., tripping characteristic SFB, 1 PDT contact, plug for base element.

Why buy this product

- ✓ Compact design with precise nominal current levels
- ✓ Modular expansion possible thanks to the uniform, plug-in housing concept
- ✓ Sophisticated remote signaling concept enables monitoring from any location
- ✓ Maximum overcurrent protection across long cable paths via SFB trigger characteristic
- ✓ Supply/remote signaling can be bridged with CLIPLINE complete accessories



Key commercial data

Packing unit	0
Minimum order quantity	1
GTIN	 4 046356 689663
Custom tariff number	85363010
Country of origin	GERMANY

Technical data

General

Installation instructions	When mounted in rows, the nominal device current can be limited to just 80% or must be oversized accordingly.
Height	45 mm
Width	12.3 mm
Depth	52 mm
Höhe Kompletmodul	90 mm
Breite Kompletmodul	12.3 mm
Tiefe Kompletmodul	77.3 mm
Ambient temperature (operation)	-30 °C ... 60 °C
Ambient temperature (storage/transport)	-40 °C ... 80 °C
Inflammability class according to UL 94	V0

Thermomagnetic device circuit breaker - CB TM1 0.5A SFB P - 2800835

Technical data

General

Degree of protection	IP30 (Actuation area)
Mounting type	On base element
Color	gray
Number of positions	1
Insulating material group	II
Pollution degree	2
Design	Male

Technical data

Fuse type	SFB
Rated surge voltage	2.5 kV (Increased insulation in actuation area)
Rated voltage	240 V AC (U _e according to IEC 60934)
Rated voltage	277 V AC (UL 1077)
Rated voltage	277 V AC (UL 508 - with plug-in base)
Rated voltage	50 V DC (IEC 60934)
Rated voltage	50 V DC (UL 1077)
Rated voltage	50 V DC (UL 508 - with plug-in base)
Rated current I _n	0.5 A (IEC 60934)
Rated current I _n	0.5 A AC (inductive load according to UL 1077)
Rated current I _n	0.5 A DC (low-induction load according to UL 1077)
Rated current I _n	0.5 A AC (inductive load according to UL 508 - with plug-in base)
Rated current I _n	0.5 A DC (low-induction load according to UL 508 - with plug-in base)
Rated insulation voltage U _i	277 V AC (UL 1077)
Rated insulation voltage U _i	250 V AC (IEC 60934)
Insulation resistance R _{iso}	> 100 MΩ (500 V DC)
Auxiliary circuit	277 V AC / 0.5 A (Low-induction)
Auxiliary circuit	277 V AC / 1 A (Low-induction, maximum of 2000 cycles)
Auxiliary circuit	50 V DC / 1 A (Low-induction)
Type of actuation	S type
Tripping method	TM (thermomagnetic)
Tripping level	Trip-free mechanism (positive)
Required backup fuse	15 A
Rated short-circuit switching capacity I _{cn}	300 A (240 V AC)
Rated short-circuit switching capacity I _{cn}	600 A (50 V DC)
Dielectric strength	3000 V AC (Actuation area)
Dielectric strength	1500 V AC (Main to auxiliary circuit)
Dielectric strength	1500 V AC (Open main circuit)
Dielectric strength	1000 V AC (Open auxiliary circuit)
Voltage drop	2.5 V (at 1 x I _n)
Cycles, max.	6000 (at 1 x I _n)
Contact type	1 PDT

Thermomagnetic device circuit breaker - CB TM1 0.5A SFB P - 2800835

Technical data

Standards

Standard - Electrical safety	EN 60934
Standard - Electrical safety	UL 1077
Standard - Electrical safety	UL 508
Standard - Electrical safety	CSA 22.2 No. 235-041

Classifications

ETIM

ETIM 3.0	EC000899
ETIM 4.0	EC000899
ETIM 5.0	EC000899

UNSPSC

UNSPSC 11	39121411
UNSPSC 12.01	39121411
UNSPSC 13.2	39121411
UNSPSC 6.01	30211812
UNSPSC 7.0901	39121411

eCl@ss

eCl@ss 4.0	27141116
eCl@ss 4.1	27141116
eCl@ss 5.0	27141116
eCl@ss 5.1	27141116
eCl@ss 6.0	27141116
eCl@ss 7.0	27141116

Approvals

Approvals

Approvals

VDE Zeichengenehmigung / UL Recognized / cUL Recognized / cULus Recognized

Ex Approvals

Approvals submitted

Approval details

Thermomagnetic device circuit breaker - CB TM1 0.5A SFB P - 2800835

Approvals

VDE Zeichengenehmigung 

UL Recognized 

cUL Recognized 

cULus Recognized 

Accessories

Accessories

Bridges

Plug-in bridge - FBS 2-6 - 3030336



Plug-in bridge, Number of positions: 2, Color: red

Plug-in bridge - FBS 3-6 - 3030242



Plug-in bridge, Number of positions: 3, Color: red

Plug-in bridge - FBS 4-6 - 3030255



Plug-in bridge, Number of positions: 4, Color: red

Thermomagnetic device circuit breaker - CB TM1 0.5A SFB P - 2800835

Accessories

Plug-in bridge - FBS 5-6 - 3030349



Plug-in bridge, Number of positions: 5, Color: red

Plug-in bridge - FBS 10-6 - 3030271



Plug-in bridge, Number of positions: 10, Color: red

Plug-in bridge - FBS 20-6 - 3030365



Plug-in bridge, Number of positions: 20, Color: red

Plug-in bridge - FBS 50-6 - 3032224



Plug-in bridge, Number of positions: 50, Color: red

Marking

Zack Marker strip, flat - ZBF 12:UNBEDRUCKT - 0809735



Zack Marker strip, flat, Strip, white, Unlabeled, Can be labeled with: Plotter, Mounting type: Snap into flat marker groove, For terminal block width: 12 mm, Lettering field: 5.15 x 12.15 mm

Thermomagnetic device circuit breaker - CB TM1 0.5A SFB P - 2800835

Accessories

Zack Marker strip, flat - ZBF 12 CUS - 0825018



Zack Marker strip, flat, Can be ordered: Strip, white, Labeled according to customer specifications, Mounting type: Snap into flat marker groove, For terminal block width: 12 mm, Lettering field: 5.15 x 12.15 mm

Tools

Cable-cutting tool - CUTFOX-FBS - 1212124



Cutting tool, for separating individual jumper bars from FBS ... plug-in bridges and EB ... insertion bridges

Jumper - CB PT BRIDGE - 2801014



Bridge plugs for the CB 1/6-2/4 PT-BE base element

Additional products

Base element - CB 1/6-2/4 PT-BE - 2800929



Base element with push-in connection technology for CB ... device circuit breakers

Drawings

Thermomagnetic device circuit breaker - CB TM1 0.5A SFB P - 2800835

Diagram

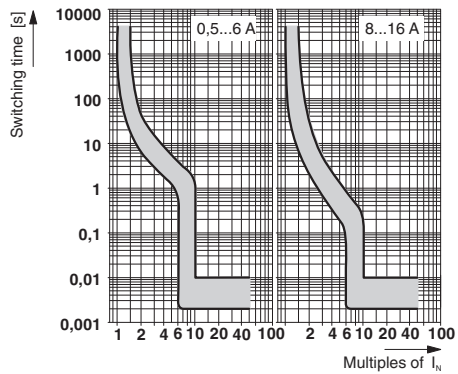

Trigger characteristic in the DC range

Thermomagnetic device circuit breaker - CB TM1 0.5A SFB P - 2800835

Application drawing

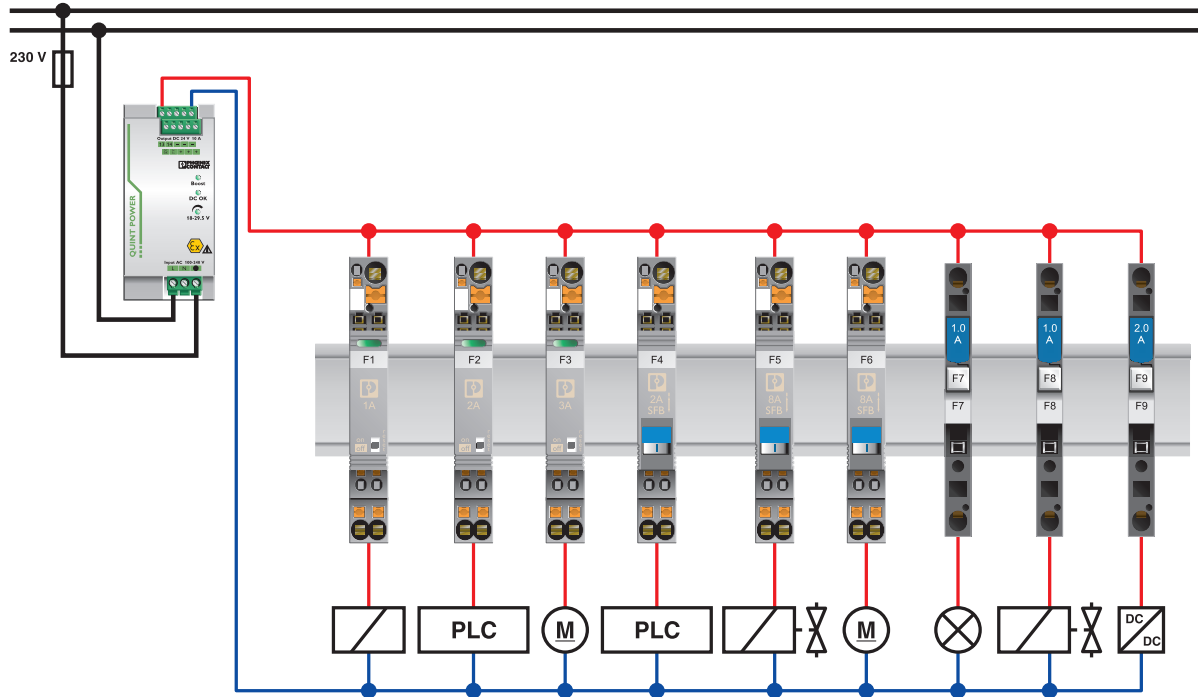

Thermomagnetic device circuit breaker - CB TM1 0.5A SFB P - 2800835

Dimensioned drawing

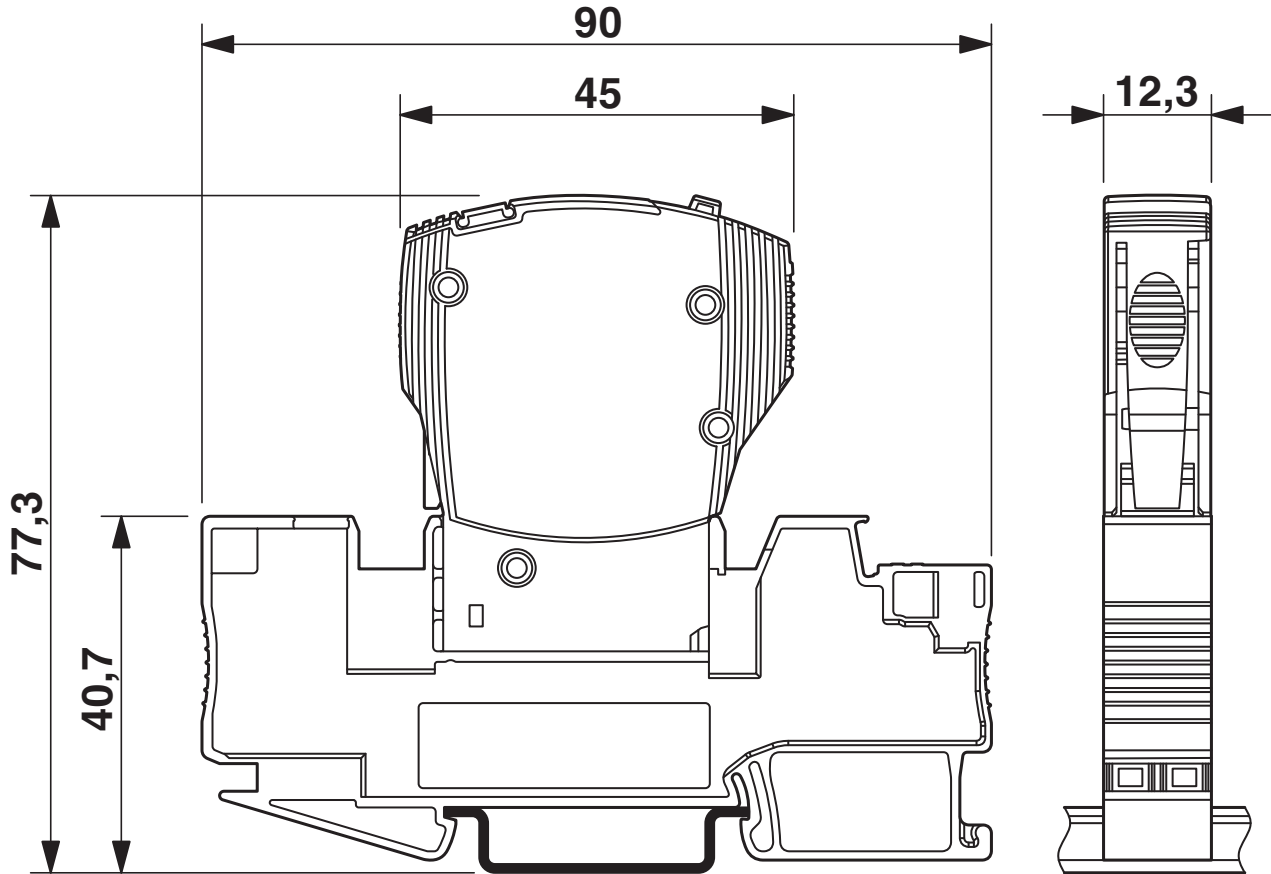

The figure shows the complete module consisting of a base element and connector



© Phoenix Contact 2012 - all rights reserved
<http://www.phoenixcontact.com>