



Chipsmall Limited consists of a professional team with an average of over 10 year of expertise in the distribution of electronic components. Based in Hongkong, we have already established firm and mutual-benefit business relationships with customers from,Europe,America and south Asia,supplying obsolete and hard-to-find components to meet their specific needs.

With the principle of “Quality Parts,Customers Priority,Honest Operation,and Considerate Service”,our business mainly focus on the distribution of electronic components. Line cards we deal with include Microchip,ALPS,ROHM,Xilinx,Pulse,ON,Everlight and Freescale. Main products comprise IC,Modules,Potentiometer,IC Socket,Relay,Connector.Our parts cover such applications as commercial,industrial, and automotives areas.

We are looking forward to setting up business relationship with you and hope to provide you with the best service and solution. Let us make a better world for our industry!



Contact us

Tel: +86-755-8981 8866 Fax: +86-755-8427 6832

Email & Skype: info@chipsmall.com Web: www.chipsmall.com

Address: A1208, Overseas Decoration Building, #122 Zhenhua RD., Futian, Shenzhen, China



Type 2 surge protection plug - VAL-MS 60 ST - 2807573

Please be informed that the data shown in this PDF Document is generated from our Online Catalog. Please find the complete data in the user's documentation. Our General Terms of Use for Downloads are valid (<http://phoenixcontact.com/download>)



Surge protection plug type 2 with high-capacity varistor for VAL-MS base element, thermal monitoring, visual fault warning. Design: 60 V AC



Key Commercial Data

Packing unit	1 STK
GTIN	 4 017918 075262
GTIN	4017918075262
Weight per Piece (excluding packing)	34.000 g
Custom tariff number	85363010
Country of origin	Germany

Technical data

Dimensions

Height	52.4 mm
Width	17.5 mm
Horizontal pitch	1 Div.

Ambient conditions

Degree of protection	IP20
Ambient temperature (operation)	-40 °C ... 80 °C
Ambient temperature (storage/transport)	-40 °C ... 80 °C
Altitude	≤ 2000 m (amsl (above mean sea level))
Permissible humidity (operation)	5 % ... 95 %
Shock (operation)	25g (half sinus / 11 ms / 3x ±X, ±Y, ±Z)

Type 2 surge protection plug - VAL-MS 60 ST - 2807573

Technical data

Ambient conditions

Vibration (operation)	5g (10 ... 500 Hz / 2.5 h / X, Y, Z)
-----------------------	--------------------------------------

General

IEC test classification	II
	T2
EN type	T2
IEC power supply system	TN
Mode of protection	L-PEN
Mounting type	On base element
Color	jet black RAL 9005
Housing material	PA 6.6
Degree of pollution	2
Flammability rating according to UL 94	V-0
Design	DIN rail module, two-section, divisible
Number of positions	1
Arrester can be tested with CHECKMASTER from software version:	From SW rev. 1.10
Surge protection fault message	optical

Protective circuit

Nominal voltage U_N	60 V AC (TN)
	60 V DC
	-48 V DC (RRH)
Nominal frequency f_N	50 Hz (60 Hz)
Maximum continuous voltage U_C	75 V AC
	100 V DC
Residual current I_{PE}	≤ 0.45 mA
Standby power consumption P_C	≤ 35 mVA
Nominal discharge current I_n (8/20) μ s	15 kA
Maximum discharge current I_{max} (8/20) μ s	40 kA
Short-circuit current rating I_{SCCR}	25 kA
Voltage protection level U_p	≤ 0.55 kV
Residual voltage U_{res}	≤ 0.55 kV (at I_n)
	≤ 0.425 kV (at 10 kA)
	≤ 0.325 kV (at 5 kA)
	≤ 0.275 kV (at 3 kA)
TOV behavior at U_T	100 V AC (5 s / withstand mode)
Response time t_A	≤ 25 ns
Max. backup fuse with branch wiring	125 A AC (gG)

Type 2 surge protection plug - VAL-MS 60 ST - 2807573

Technical data

Protective circuit

	50 A DC (gG)
--	--------------

Connection data

Connection method	VALVETRAB plug-in system
-------------------	--------------------------

UL specifications

SPD Type	4CA
Maximum continuous operating voltage MCOV (L-N)	75 V AC
Maximum continuous operating voltage MCOV (L+) - (L-)	100 V DC
Nom. voltage	60 V AC
Nominal voltage	60 V DC
Mode of protection	L-N
	(L+) - (L-)
Power distribution system	1
Nominal frequency	50/60 Hz
Measured limiting voltage MLV (L-N)	630 V
Measured limiting voltage MLV (L+) - (L-)	810 V
Nominal discharge current I_n (L-N)	10 kA
Nominal discharge current I_n (L+) - (L-)	10 kA

Standards and Regulations

Standards/regulations	IEC 61643-11 2011
	EN 61643-11 2012

Drawings

Dimensional drawing

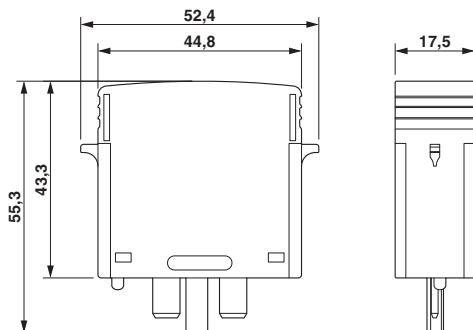

Circuit diagram



Type 2 surge protection plug - VAL-MS 60 ST - 2807573

Classifications

eCl@ss

eCl@ss 4.0	27140201
eCl@ss 4.1	27130801
eCl@ss 5.0	27130801
eCl@ss 5.1	27130801
eCl@ss 6.0	27130805
eCl@ss 7.0	27130805
eCl@ss 8.0	27130805
eCl@ss 9.0	27130805

ETIM

ETIM 2.0	EC000941
ETIM 3.0	EC000941
ETIM 4.0	EC000941
ETIM 5.0	EC000941
ETIM 6.0	EC000941

UNSPSC

UNSPSC 6.01	30212010
UNSPSC 7.0901	39121610
UNSPSC 11	39121610
UNSPSC 12.01	39121610
UNSPSC 13.2	39121620

Approvals

Approvals

Approvals

IECEE CB Scheme / CSA / UL Recognized / KEMA-KEUR / ÖVE / cUL Recognized / CCA / EAC / cULus Recognized







Ex Approvals

Approval details

IECEE CB Scheme		http://www.iecee.org/	AT 2905/M1
-----------------	--	---	------------

Type 2 surge protection plug - VAL-MS 60 ST - 2807573

Approvals

CSA		http://www.csagroup.org/services/testing-and-certification/certified-product-listing/	13631
UL Recognized		http://database.ul.com/cgi-bin/XYV/template/LISEXT/1FRAME/index.htm	FILE E 330181
KEMA-KEUR		http://www.dekra-certification.com	2170208.01
ÖVE		https://www.ove.at/en/certification-pz/certification-register/	18583-001-12
cUL Recognized		http://database.ul.com/cgi-bin/XYV/template/LISEXT/1FRAME/index.htm	FILE E 330181
CCA			NTR-AT 1947-A
EAC			RU C- DE.A*30.B01561
cULus Recognized		http://database.ul.com/cgi-bin/XYV/template/LISEXT/1FRAME/index.htm	

Accessories

Accessories

Bridge

Type 2 surge protection plug - VAL-MS 60 ST - 2807573

Accessories

Wiring bridge - MPB F600X16/ 1GS - 2818355



Wiring bridge flexible, diameter: 16 mm², with a fork-type cable lug on one side, length: 600 mm

Wiring bridge - MPB F400X16/ 1GS - 2818342



Wiring bridge flexible, diameter 16 mm², with a fork-type cable lug on one side, length: 400 mm

Wiring bridge - MPB F200X16/ 1GS - 2818339



Wiring bridge flexible, diameter 16 mm², with a fork-type cable lug on one side, length: 200 mm

Wiring bridge - MPB 18/1-10/1.0.0 - 2830443



Wiring bridge for modules with connecting pitch 17.5 mm, 1-phase, 10 pitches with contact sequence 1-0-0

Wiring bridge - MPB 18/4-12 - 2809296



Wiring bridge for modules with connecting pitch 17.5 mm, 4-phase, 12-pos.

Type 2 surge protection plug - VAL-MS 60 ST - 2807573

Accessories

Wiring bridge - MPB 18/4- 8 - 2809283



Wiring bridge for modules with connecting pitch 17.5 mm, 4-phase, 8-pos.

Wiring bridge - MPB 18/3- 6 - 2809241



Wiring bridge for modules with connecting pitch 17.5 mm, 3-phase, 6-pos.

Wiring bridge - MPB 18/1-57 - 2809238



Wiring bridge for modules with connecting pitch 17.5 mm, 1-phase, 57-pos.

Wiring bridge - MPB 18/1-12 - 2748593



Wiring bridge for modules with connecting pitch 17.5 mm, 1-phase, 12-pos.

Wiring bridge - MPB 18/1- 9 - 2748580



Wiring bridge for modules with connecting pitch 17.5 mm, 1-phase, 9-pos.

Type 2 surge protection plug - VAL-MS 60 ST - 2807573

Accessories

Wiring bridge - MPB 18/1- 8 - 2748577



Wiring bridge for modules with connecting pitch 17.5 mm, 1-phase, 8-pos.

Wiring bridge - MPB 18/1- 6 - 2748564



Wiring bridge for modules with connecting pitch 17.5 mm, 1-phase, 6-pos.

Wiring bridge - MPB 18/1- 4 - 2809225



Wiring bridge for modules with connecting pitch 17.5 mm, 1-phase, 4-pos.

Wiring bridge - MPB 18/1- 3 - 2809212



Wiring bridge for modules with connecting pitch 17.5 mm, 1-phase, 3-pos.

Wiring bridge - MPB 18/1- 2 - 2809209



Wiring bridge for modules with connecting pitch 17.5 mm, 1-phase, 2-pos.

Device marking

Type 2 surge protection plug - VAL-MS 60 ST - 2807573

Accessories

Zack marker strip - ZBN 18:UNBEDRUCKT - 2809128



Zack marker strip, Strip, white, unlabeled, can be labeled with: CMS-P1-PLOTTER, PLOTMARK, Mounting type: Snap into tall marker groove, for terminal block width: 18 mm, Lettering field: 18 x 5 mm

Labeled device marker

Marker for terminal blocks - ZBN 18,LGS:ERDE - 2749589



Marker for terminal blocks, Strip, white, labeled, Horizontal: Grounding symbol, Mounting type: Snap into tall marker groove, for terminal block width: 18 mm, Lettering field: 18 x 5 mm

Marker for terminal blocks - ZBN 18,LGS:L1-N,ERDE - 2749576



Marker for terminal blocks, Strip, white, labeled, Horizontal: L1, L2, L3, N, GND, Mounting type: Snap into tall marker groove, for terminal block width: 18 mm, Lettering field: 18 x 5 mm

Marker pen

Marker pen - B-STIFT - 1051993



Marker pen, for manual labeling of unprinted Zack strips, smear-proof and waterproof, line thickness 0.5 mm

Additional products

Type 2 surge protection plug - VAL-MS 60 ST - 2807573

Accessories

Type 2 surge protection base element - VAL-MS BE - 2817741



Base element for type 2 arresters of the VALVETRAB MS series of products. Design: 1-channel

Type 2 surge protection base element - VAL-MS BE/FM - 2817738



Base element for type 2 arresters of the VALVETRAB MS series of products, with remote indication contact. Design: 1-channel
