



Chipsmall Limited consists of a professional team with an average of over 10 year of expertise in the distribution of electronic components. Based in Hongkong, we have already established firm and mutual-benefit business relationships with customers from,Europe,America and south Asia,supplying obsolete and hard-to-find components to meet their specific needs.

With the principle of “Quality Parts,Customers Priority,Honest Operation,and Considerate Service”,our business mainly focus on the distribution of electronic components. Line cards we deal with include Microchip,ALPS,ROHM,Xilinx,Pulse,ON,Everlight and Freescale. Main products comprise IC,Modules,Potentiometer,IC Socket,Relay,Connector.Our parts cover such applications as commercial,industrial, and automotives areas.

We are looking forward to setting up business relationship with you and hope to provide you with the best service and solution. Let us make a better world for our industry!



Contact us

Tel: +86-755-8981 8866 Fax: +86-755-8427 6832

Email & Skype: info@chipsmall.com Web: www.chipsmall.com

Address: A1208, Overseas Decoration Building, #122 Zhenhua RD., Futian, Shenzhen, China



LOC	DIST	REVISIONS REVISIONI			
P	LTR REV	DESCRIPTION DESCRIZIONE	DATE DATA	DWN DIS.	APVD APP.
	A	FIRST ISSUE EC ET00-0065-99 (WAS 96-51009)	FEB99	A.M.	O.C.
	AI	RELEASED FOR PRODUCTION ET00 0201-99	07 Sept 99	G. S.	O.C.

SECTION A-A
(SEZIONE A-A)

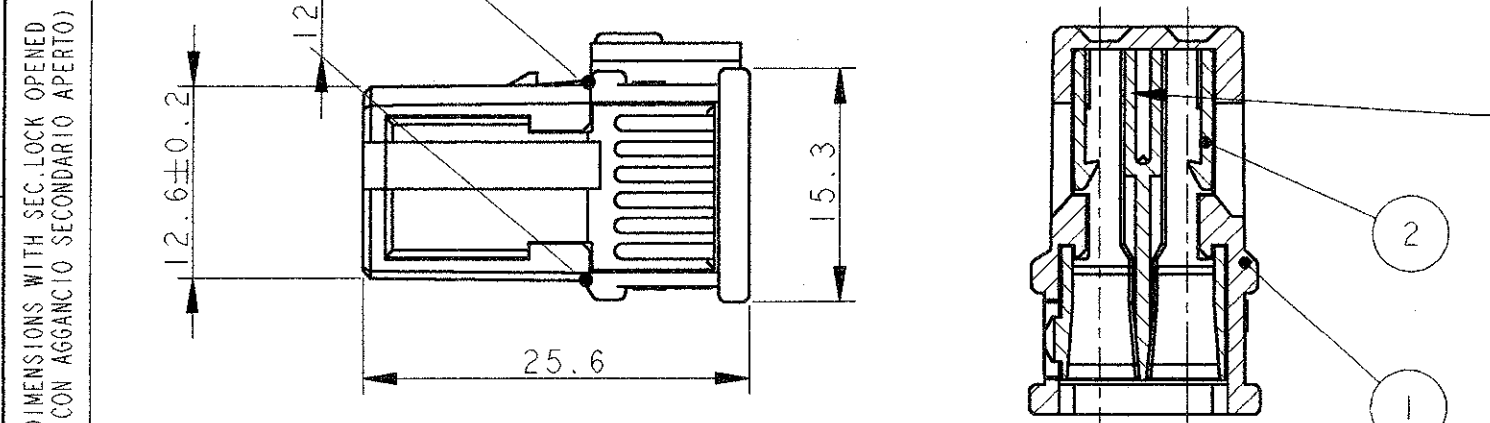

SUPPLIED WITH SEC. LOCKING DEVICE ON PRE-ASSEMBLED POSITION (FORNITO CON IL DISPOSITIVO DI AGGANCIAMENTO SECONDARIO IN POS. PRE-ASSEMBLATO)

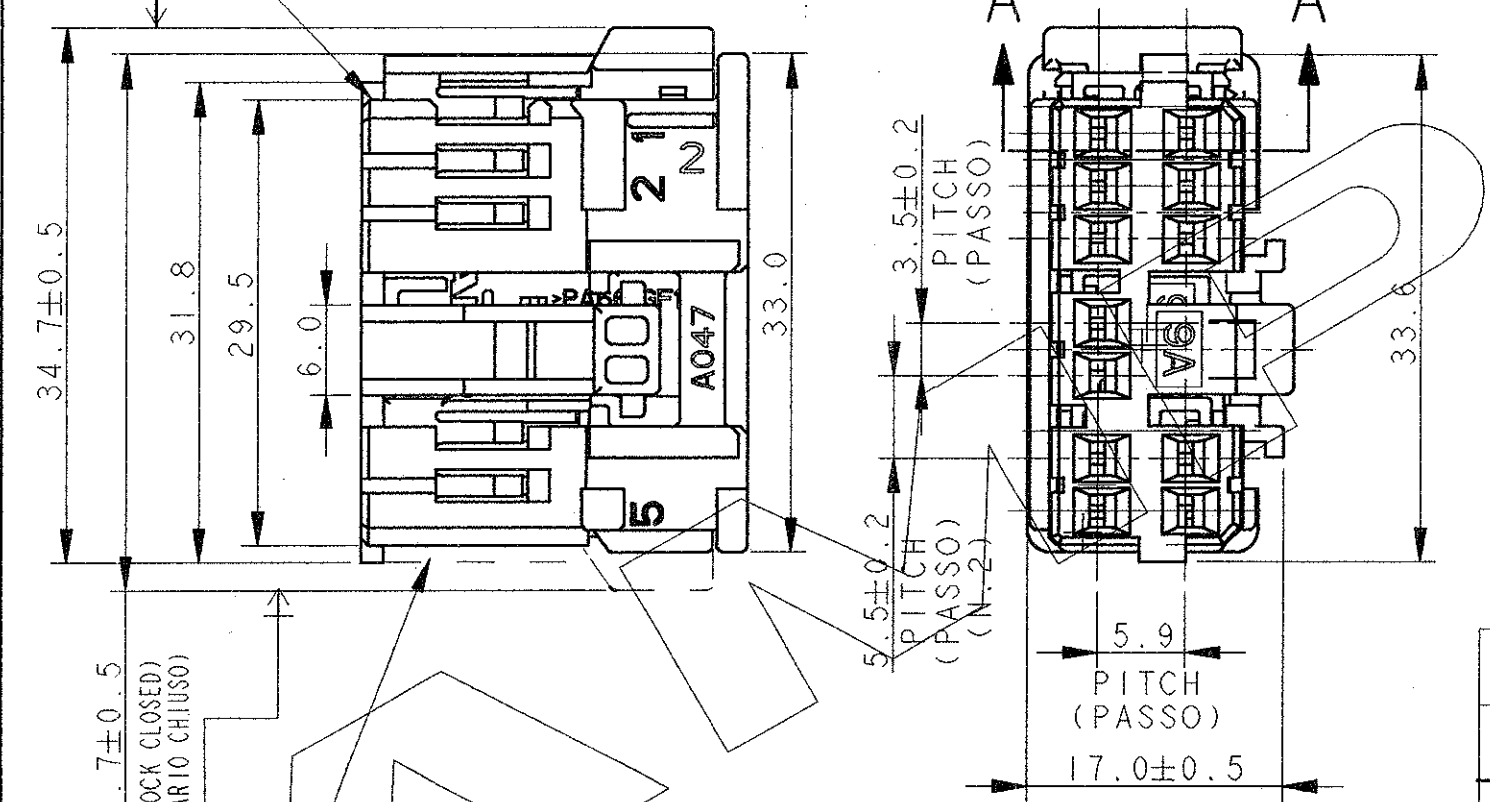

OVERALL DIMENSIONS WITH SEC. LOCK CLOSED (INGOMBRO CON AGGANCIAMENTO SECONDARIO CHIUSO)

FOR POLARIZATION DETAILS AND COUNTERPARTS P/N'S SEE SHEET 2 (PER DETTAGLIO POLARIZZAZIONI E P/N'S CONTROPARTI VEDERE FOGLIO 2)

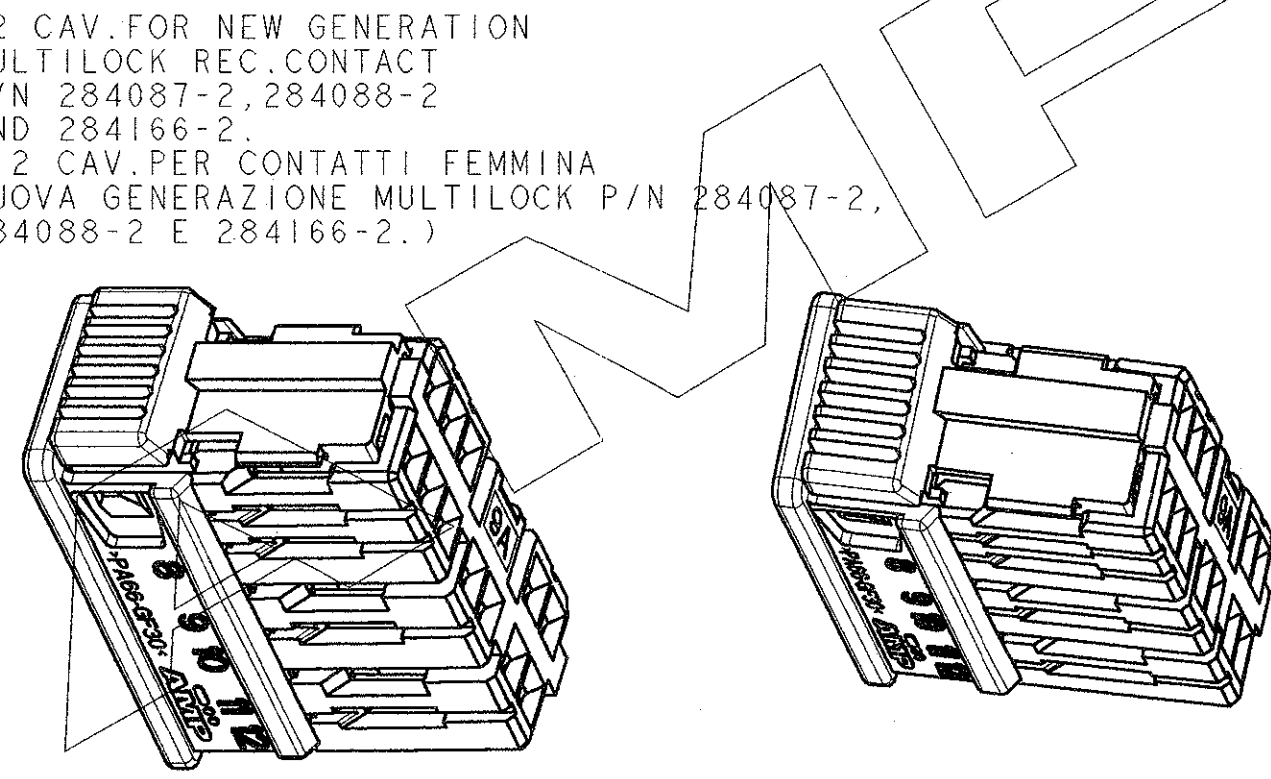

282990-2 AS SHOWN (COME MOSTRATO)

ITEM	DESCRIPTION (DESCRIZIONE)	FINISH/COLOR (FINITURA/COLORE)	MATERIAL (MATERIALE)	PART NUMBER (NUMERO)
2	RECEPTACLE HOUSING (BLOCC. PORTA FEMMINE)	SEE SHEET 2 VED. FOGLIO 2	PA 66 G.F.	SEE SHEET 2 VED. FOGLIO 2
1	SEC. LOCKING DEVICE (AGGANCIAMENTO SECONDARIO)	SEE SHEET 2 VED. FOGLIO 2	PA 66 G.F.	SEE SHEET 2 VED. FOGLIO 2

THIS DRAWING IS A CONTROLLED DOCUMENT FOR AMP INCORPORATED. IT IS SUBJECT TO CHANGE AND THE CONTROLLING ENGINEERING ORGANIZATION SHOULD BE CONTACTED FOR THE LATEST REVISION. QUESTO DISEGNO E' UN DOCUMENTO DI PROPRIETA' E RESPONSABILITA' DELL'AMP ITALIA S.P.A. SOGGETTO A VARIAZIONI. PER OTTENERE L'ULTIMA REVISIONE DEL DISEGNO CONTATTARE AMP ITALIA S.P.A.		DWN / DIS. 4-MAR-99 ANDREA MARANGON CHK / CONT. 4-MAR-99 OSCARE CANUTO APVD / APP. 4-MAR-99 ALESSANDRO GENTA		AMP AMP ITALIA SpA. C.so Filii Cervi 15 COLLEGNO (TO)	
DIMENSIONS: DIMENSIONI: mm		TOLERANCES UNLESS OTHERWISE SPECIFIED: TOLLERANZE: SE NON DIVERSAMENTE SPECIFICATO 0 PLC / DEC ±0.3 1 PLC / DEC ±0.3 2 PLC / DEC ± 3 PLC / DEC ± 4 PLC / DEC ± ANGLES / ANGOLI ±2		NAME: NAME 12 POS. NEW GENERATION RECEPTACLE CONNECTOR for trucks	
MATERIAL: MATERIALE SEE TABLE (VEDI TABELLA)		FINISH: FINITURA -		SIZE: A3 CAGE CODE: 00779 DRAWING NO: 282990	
WEIGHT: PESO 5.5 g		APPLICATION SPEC: SPEC. DI APPLICAZIONE 114-20098		SCALE: 2:1 SHEET: 1 OF 2 REV: AI	
CUSTOMER DRAWING FOR REFERENCE ONLY		DISEGNO PER CLIENTE SOLO PER RIFERIMENTO		SCALE: 2:1 SHEET: 1 OF 2 REV: AI	

LOC	DIST	REVISIONS REVISIONI		
		P	LTR REV	DESCRIPTION DESCRIZIONE
				DATE DATA
				DWN DIS.
				APVD APP.
SEE SHEET 1, (VEDERE FOGLIO 1)				

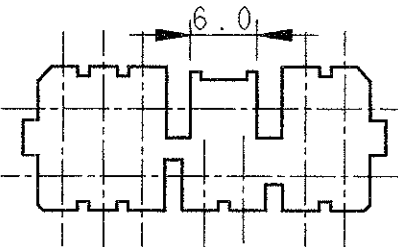
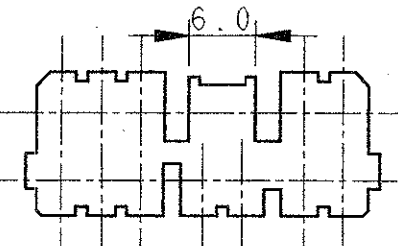
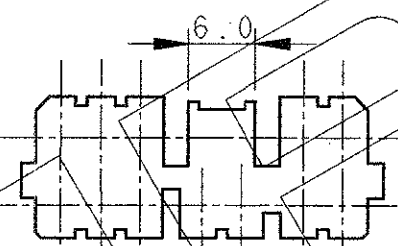
P/N	ITEM 1 COLOUR (COLORE)	GRAPHIC REPRESENTATION MATING FACE (RAPPRESENTAZIONE GRAFICA LATO ACCOPPIAMENTO)	P/N FREE HANGING COUNTERPART (CONTROPARTE VOLANTE)	P/N APPLICATION PANEL (DIMA DI APPLICAZIONE)
282990-2	BLACK (NERO)		282993-2	92-51126-2
282990-3	BLUE (BLU)		282993-3	92-51126-3
282990-4	GREY (GRIGIO)		282993-4	92-51126-4

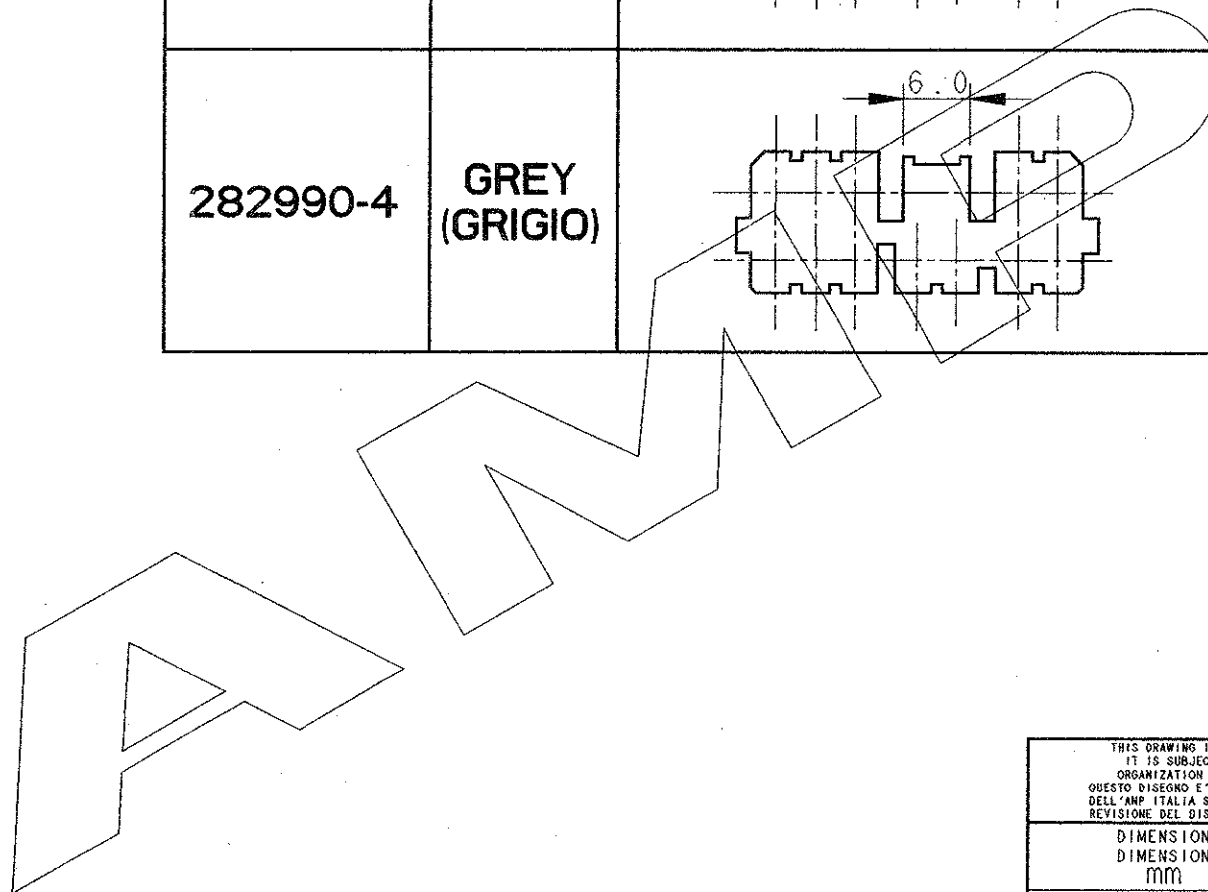

THIS DRAWING IS A CONTROLLED DOCUMENT FOR AMP INCORPORATED. IT IS SUBJECT TO CHANGE AND THE CONTROLLING ENGINEERING ORGANIZATION SHOULD BE CONTACTED FOR THE LATEST REVISION. QUESTO DISEGNO E' UN DOCUMENTO DI PROPRIETA' E RESPONSABILITA' DELL'AMP ITALIA S.p.A. SOGGETTO A VARIAZIONI. PER OTTENERE L'ULTIMA REVISIONE DEL DISEGNO CONTATTARE AMP ITALIA S.p.A.		DWN / DIS. 4-MAR-99 ANDREA MARANGON CHK / CONT. 4-MAR-99 OSCARE CANUTO APVD / APP. 4-MAR-99 ALESSANDRO GENTA	AMP AMP ITALIA Sp.A. C.so Filii Cervi 15 COLLEGNO (TO)
DIMENSIONS: DIMENSIONI: mm	TOLERANCES UNLESS OTHERWISE SPECIFIED: TOLLERANZE, SE NON DIVERSAMENTE SPECIFICATO	NAME NONE	12 POS. NEW GENERATION RECEPTACLE CONNECTOR for trucks
	0 PLC / DEC ±0.3 1 PLC / DEC ±0.3 2 PLC / DEC ± 3 PLC / DEC ± 4 PLC / DEC ± ANGLES / ANGOLI ±2	PRODUCT SPEC SPEC DI PRODOTTO SEE SHEET 1 (VEDERE FOGLIO 1) APPLICATION SPEC SPEC DI APPLICAZIONE SEE SHEET 1 (VEDERE FOGLIO 1)	SIZE A3
MATERIAL MATERIALE SEE SHEET 1 (VEDERE FOGLIO 1)	FINISH FINITURA -	WEIGHT PESO SEE SHEET 1 (VEDERE FOGLIO 1)	CAGE CODE 00779
CUSTOMER DRAWING FOR REFERENCE ONLY		DISEGNO PER CLIENTE SOLO PER RIFERIMENTO	DRAWING NO NUMERO 282990
		SCALE SCALA -	SHEET FOGLIO 2 OF 2 REV A1