

Chipsmall Limited consists of a professional team with an average of over 10 year of expertise in the distribution of electronic components. Based in Hongkong, we have already established firm and mutual-benefit business relationships with customers from,Europe,America and south Asia,supplying obsolete and hard-to-find components to meet their specific needs.

With the principle of “Quality Parts,Customers Priority,Honest Operation,and Considerate Service”,our business mainly focus on the distribution of electronic components. Line cards we deal with include Microchip,ALPS,ROHM,Xilinx,Pulse,ON,Everlight and Freescale. Main products comprise IC,Modules,Potentiometer,IC Socket,Relay,Connector.Our parts cover such applications as commercial,industrial, and automotives areas.

We are looking forward to setting up business relationship with you and hope to provide you with the best service and solution. Let us make a better world for our industry!



Contact us

Tel: +86-755-8981 8866 Fax: +86-755-8427 6832

Email & Skype: info@chipsmall.com Web: www.chipsmall.com

Address: A1208, Overseas Decoration Building, #122 Zhenhua RD., Futian, Shenzhen, China

REL-IR/L-120AC/4X21AU

Order No.: 2834135

The figure shows version: REL-IR/L-230AC/4X21 AU



<http://eshop.phoenixcontact.de/phoenix/treeViewClick.do?UID=2834135>

Plug-in industrial relay with power contacts and additional hard gold plating, 4 PDTs, test button, status LED, mechanical switch setting display, coil voltage: 120 V AC

Commercial data	
GTIN (EAN)	4  017918 941826
sales group	G082
Pack	10 pcs.
Customs tariff	85364900
Catalog page information	Page 60 (IF-2009)

Product notes

WEEE/RoHS-compliant since:
03/30/2007



<http://www.download.phoenixcontact.com>
Please note that the data given here has been taken from the online catalog. For comprehensive information and data, please refer to the user documentation. The General Terms and Conditions of Use apply to Internet downloads.

Technical data

Coil side	
Nominal input voltage U_N	120 V AC
Nominal input current at U_{IN}	11 mA (at 50 Hz) 9 mA (At 60 Hz)
Typical response time	4 ms ... 10 ms (AC, depending on phase relation)

Typical release time range	3 ms ... 12 ms (AC, depending on phase relation)
Coil resistance	4430 Ω +/-15% (at 20°C)

Contact side

Contact type	Single contact, 4-PDT
Contact material	AgNi, hard gold-plated
Maximum switching voltage	250 V AC/DC
Minimum switching voltage	1 V
Maximum inrush current	12 A (15 ms)
Min. switching current	1 mA
Limiting continuous current	5 A
Interrupting rating (ohmic load) max.	1250 VA (for 250 V AC)

General data

Width	21.5 mm
Height	28 mm
Depth	36 mm
Test voltage relay winding/relay contact	2 kV AC (50 Hz, 1 min.)
Test voltage relay contact/relay contact	2 kV AC (50 Hz, 1 min.)
Ambient temperature (operation)	-55 °C ... 70 °C
Ambient temperature (storage/transport)	-55 °C ... 70 °C
Operating mode	100% operating factor
Mechanical service life	5 x 10 ⁷ cycles
Standards/regulations	DIN EN 61810-1
	VDE 0435-201
	EN 50178
	IEC 62103
Pollution degree	2
Surge voltage category	II
Mounting position	Any
Assembly instructions	On relay base PR2

Connection data

Type of connection	Plug / solder connection
--------------------	--------------------------

Certificates / Approvals



Certification

CUL Listed, UL Listed, VDE-PZI

Diagrams/Drawings

Diagram

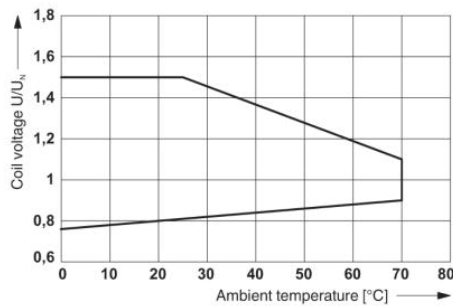

Operating voltage range

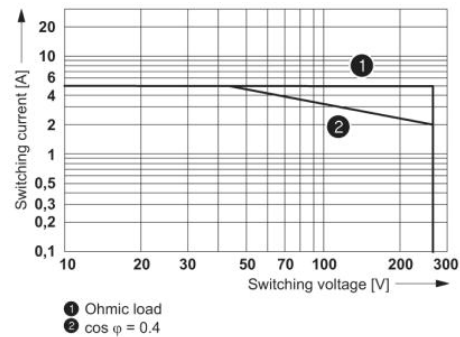

Interrupting rating

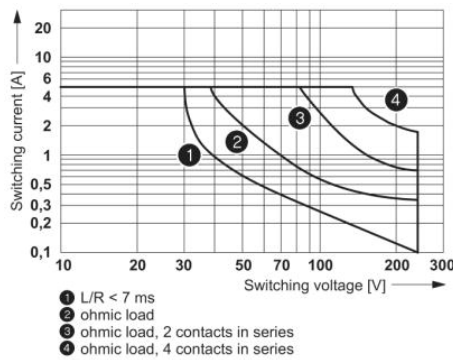

DC interrupting rating

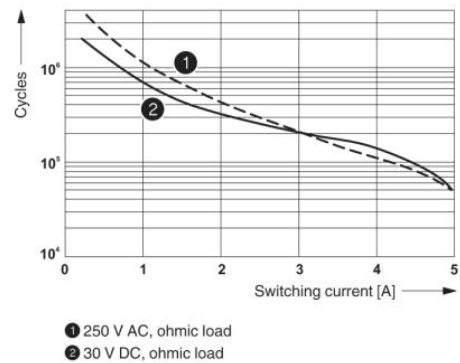

Electrical service life

Service life reduction factor

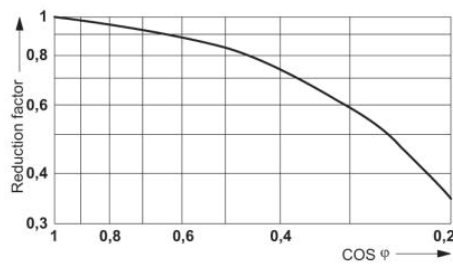

Circuit diagram

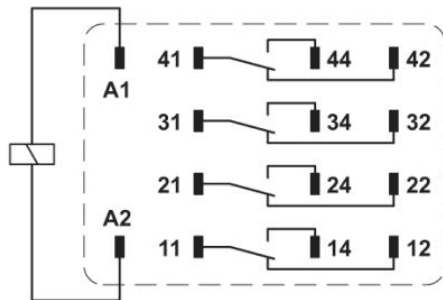

Shown without LED and damping diode.

Address

PHOENIX CONTACT Deutschland GmbH
Flachmarktstr. 8
32825 Blomberg, Germany
Phone +49 5235 3 12000
Fax +49 5235 3 41200
<http://www.phoenixcontact.de>



© 2011 Phoenix Contact
Technical modifications reserved;