



Chipsmall Limited consists of a professional team with an average of over 10 year of expertise in the distribution of electronic components. Based in Hongkong, we have already established firm and mutual-benefit business relationships with customers from,Europe,America and south Asia,supplying obsolete and hard-to-find components to meet their specific needs.

With the principle of “Quality Parts,Customers Priority,Honest Operation,and Considerate Service”,our business mainly focus on the distribution of electronic components. Line cards we deal with include Microchip,ALPS,ROHM,Xilinx,Pulse,ON,Everlight and Freescale. Main products comprise IC,Modules,Potentiometer,IC Socket,Relay,Connector.Our parts cover such applications as commercial,industrial, and automotives areas.

We are looking forward to setting up business relationship with you and hope to provide you with the best service and solution. Let us make a better world for our industry!



## Contact us

Tel: +86-755-8981 8866 Fax: +86-755-8427 6832

Email & Skype: info@chipsmall.com Web: www.chipsmall.com

Address: A1208, Overseas Decoration Building, #122 Zhenhua RD., Futian, Shenzhen, China



# PR2 Relay Base for: – Industrial DPDT or 4PDT Relays

## Universal Modular System

The 27 mm\* (1.063 in.) wide PR2 relay base range is a modular system consisting of PR2-B... relay bases, robust REL-IR... electromechanical industrial relays with DPDT and 4PDT contacts, and a comprehensive range of accessories. These include:

- Plug-in input/interference suppression modules
- Relay retaining bracket with labeling field and eject function
- Labels
- Continuous jumpers

Depending on the application, complete coupling relays can be created, which are optimized in terms of cost and function.

## Base Versions

The relay bases are available in three versions - the flat 2/2 level PR2-BSC2 type with screw connections, and the "logical" 1/3 level PR2-BSC3 with screw connections and PR2-BSP3 with spring-cage connections. The logical versions have coil and contact connections that are located opposite one another and thus meet the requirements of modern control cabinet concepts with clear isolation of control signals and load.

## Robust, Cost-Effective Industrial Relays

Industrial relays are used in many sectors of industry due to their robust structure, which has 2.6 mm (0.102 in.) flat pins. The main features of the REL/IR... series include the fully automated manufacture of products in conjunction with the high degree of product stability and global availability. The following versions are available:





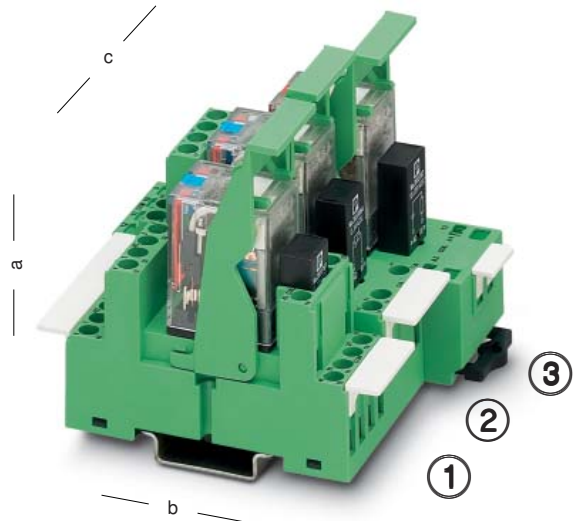

- With two 10 A 2PDT contacts
- With four 5 A 4PDT contacts
- In all popular AC and DC coil voltages

Considerably wider and more expensive miniature contactors can thus be replaced cost-effectively in many applications without adversely affecting machine or system operation. All industrial relays have the following standard features:

- Manual test key (AC coil = red key, DC coil = blue key)
- Mechanical switch setting display
- LED status indicators
- Free-wheeling diode (only DC types)
- Power contacts with solid gold coating (only types with 4PDT contacts)

\*) Spring-cage version is 31 mm (1.220 in.) wide



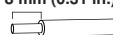
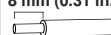
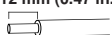





	①	②	③
	PR2-BSC2...	PR2-BSC3...	PR2-BSP3...
Nominal voltage U <sup>1)</sup>	300 V AC	300 V AC	300 V AC
Nominal current I <sup>1)</sup>	12 A	12 A	10 A
Conductor cross section			
– Solid	2 x 2.5 mm <sup>2</sup>	2 x 2.5 mm <sup>2</sup>	2 x 1.5 mm <sup>2</sup>
– Flexible	2 x 2.5 mm <sup>2</sup>	2 x 2.5 mm <sup>2</sup>	2 x 1.5 mm <sup>2</sup>
American Wire Gauge	2 x 14 AWG	2 x 14 AWG	2 x 16 AWG
Connection type	 M 3	 M 3	 3)
Approvals <sup>2)</sup>			
Stripping length	8 mm (0.31 in.) 	8 mm (0.31 in.) 	12 mm (0.47 in.) 
Height (a) with retaining bracket: – EL2-P35	84 mm (3.307 in.)	86 mm (3.386 in.)	84 mm (3.307 in.)
Depth (b)	75 mm (2.953 in.)	78.5 mm (3.091 in.)	95 mm (3.740 in.)
Width (c)	27 mm (1.063 in.)	27 mm (1.063 in.)	31 mm (1.220 in.)
Ambient temperature	-25°C...+85°C (-13°F...+185°F)	-25°C...+85°C (-13°F...+185°F)	-25°C...+85°C (-13°F...+185°F)

<sup>1)</sup> The maximum electrical data is relay dependent.

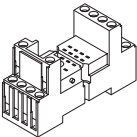
<sup>2)</sup> Details on request.

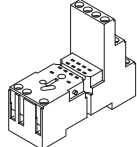
<sup>3)</sup> Two spring-cage connections per terminal point.

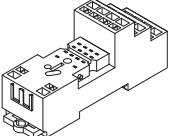
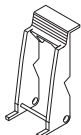
# PR2 Relay Base for Industrial DPDT or 4PDT Relays

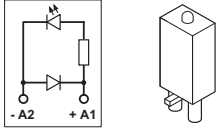
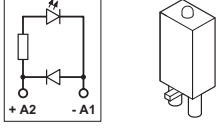
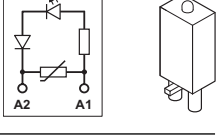
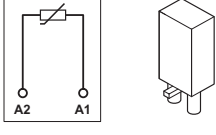
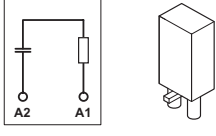
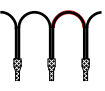
Description	Type	Order No.	Pcs. Pkt.
<p><b>PR2-B relay base</b>, for REL-IR Industrial DPDT or 4PDT Relays, 2/2 level version, screw connections, optional connection of input/interference suppression module, for mounting on , including MP2 markers, 10 pcs. per pack</p> 	PR2-BSC2/4x21	28 33 56 3	10
<p><b>PR2-B relay base</b>, for REL-IR Industrial DPDT or 4PDT Relays, 1/3 level version, screw connections, optional connection of input/interference suppression module, for mounting on , including MP2 markers, 10 pcs. per pack</p> 	PR2-BSC3/4x21	28 33 57 6	10
<p><b>PR2-B relay base</b>, for REL-IR Industrial DPDT or 4PDT Relays, 1/3 level version, spring-cage connections, optional connection of input/interference suppression module, for mounting on , including MP1 markers, 10 pcs. per pack</p> 	PR2-BSP3/4x21	28 33 58 9	10
<p><b>Relay retaining bracket</b>, with eject function and integrated device marking area (8 x 25 mm [0.315 x 0.984 in.]), suitable for PR2 relay base: – For 35 mm (1.378 in.) high industrial relays</p> 	EL2-P35	28 33 59 2	10
<p><b>Device marker:</b> – Suitable for PR2-BSP, 6 x 15 mm (0.236 x 0.591 in.) marking area – Suitable for PR2-BSC, 9 x 25 mm (0.354 x 0.984 in.) marking area</p> 	MP1 MP2	28 33 63 1 28 33 64 4	10 10
<p><b>Plug-in module</b>, for mounting on PR1 and PR2, with free-wheeling diode and yellow LED, polarity: <b>A1 +, A2 –</b> Input voltage: – 12 - 24 V DC ±20% – 48 - 60 V DC ±20% – 110 V DC ±20%</p> 	LDP-12-24DC <sup>1)</sup> LDP-48-60DC <sup>1)</sup> LDP-110DC <sup>1)</sup>	28 33 65 7 28 33 66 0 28 33 67 3	10 10 10
<p><b>Plug-in module</b>, for mounting on PR1 and PR2, with free-wheeling diode and yellow LED, polarity: <b>A1 –, A2 +</b> (Japanese standard) Input voltage: – 12 - 24 V DC ±20% – 48 - 60 V DC ±20% – 110 V DC ±20%</p> 	LDM-12-24DC <sup>1)</sup> LDM-48-60DC <sup>1)</sup> LDM-110DC <sup>1)</sup>	28 33 68 6 28 33 69 9 28 33 70 9	10 10 10
<p><b>Plug-in module</b>, for mounting on PR1 and PR2, with varistor and yellow LED, input voltage: – 12 - 24 V AC/DC ±20% – 48 - 60 V AC/DC ±20% – 120 - 230 V AC/110 V DC ±20%</p> 	LV-12-24UC (30 V varistor) LV-48-60UC (75 V varistor) LV-120-230AC/110 DC (275 V varistor)	28 33 71 2 28 33 72 5 28 33 73 8	10 10 10
<p><b>Plug-in module</b>, for mounting on PR1 and PR2, with varistor Input voltage: – 12 - 24 V AC/DC ±20% – 48 - 60 V AC/DC ±20% – 120 - 230 V AC/DC ±20%</p> 	V-12-24UC (30 V varistor) V-48-60UC (75 V varistor) V-120-230UC (275 V varistor)	28 33 86 4 28 33 87 7 28 33 88 0	10 10 10
<p><b>Plug-in module</b>, for mounting on PR1 and PR2, with RC element Input voltage: – 12 - 24 V AC/DC ±20% – 48 - 60 V AC/DC ±20% – 120 - 230 V AC/DC ±20%</p> 	RC-12-24UC (220 nF/100 Ω) RC-48-60UC (220 nF/220 Ω) RC-120-230UC (100 nF/470 Ω)	28 33 74 1 28 33 75 4 28 33 76 7	10 10 10
<p><b>Wire jumper</b>, 50-pos., can be separated, maximum jumpering distance of 60 mm (2.36 in.), 0.5 mm<sup>2</sup> (20 AWG), insulation: – Blue – Black – Gray</p> 	DB 50-90 BU DB 50-90 BK DB 50-90 GY	28 21 18 0 28 20 91 6 28 20 92 9	1 1 1

<sup>1)</sup>Might not be required, as LED and free-wheeling diode are already integrated in the REL-IR/LD... relays.

# Plug-In Industrial Relays With DPDT Contacts, Suitable for PR2 Relay Base

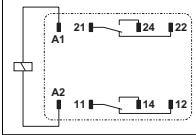
<p>Description</p> <p><b>Plug-in industrial relays<sup>1)</sup> with power contacts, DPDT contacts</b>, test key, status LED, free-wheeling diode, mechanical switch setting display, polarity: <b>A1 +, A2 -</b>          Coil voltage:          - 12 V DC          - 24 V DC          - 48 V DC          - 110 V DC</p> <p><b>Plug-in industrial relays<sup>1)</sup> with power contacts, DPDT contacts</b>, test key, status LED, free-wheeling diode, mechanical switch setting display, polarity: <b>A1 -, A2 +</b> (Japanese standard)          Coil voltage:          - 12 V DC          - 24 V DC          - 48 V DC          - 110 V DC</p> <p><b>Plug-in industrial relays<sup>1)</sup> with power contacts, DPDT contacts</b>, test key, status LED, mechanical switch setting display          Coil voltage:          - 24 V AC          - 120 V AC          - 230 V AC</p>	   <p>Representation without LED and free-wheeling diode.</p> <p>Contacts 21, 22, and 24 are led to relay base connections 41, 42, and 44.</p>
---	--

**Technical Data**

<b>Coil Side DC Coils</b>	
Nominal input voltage $U_N$	12 V DC    24 V DC    48 V DC    110 V DC
Permissible range (with reference to $U_N$ )	See diagram on page 5
Typical input current at $U_N$	75 mA    38 mA    19 mA    10 mA
Typical response time at $U_N$	13 ms    13 ms    13 ms    13 ms
Typical release time at $U_N$	5 ms    5 ms    5 ms    5 ms
DC coil resistance at 20°C (68°F)	160 Ω ±15%    630 Ω ±15%    2560 Ω ±15%    11100 Ω ±15%

<b>Coil Side AC Coils (50 Hz/60 Hz)</b>	
Nominal input voltage $U_N$	24 V AC    120 V AC    230 V AC
Permissible range (with reference to $U_N$ )	See diagram on page 5
Typical input current at $U_N$ (50 Hz/60 Hz)	54 mA/46 mA    11 mA/9 mA    5 mA/4 mA
Typical response time at $U_N$ (depending on phase relation)	4 - 10 ms    4 - 10 ms    4 - 10 ms
Typical release time at $U_N$ (depending on phase relation)	3 - 12 ms    3 - 12 ms    3 - 12 ms
DC coil resistance at 20°C (68°F)	180 Ω ±15%    4430 Ω ±15%    18790 Ω ±15%

<b>Contact Side</b>	
Contact type	REL-IR...2x21
Contact material	Single contact, 2 PDT contacts
Maximum switching voltage	Ag
Minimum switching voltage	250 V AC/125 V DC
Limiting continuous current	5 V
Maximum inrush current	10 A
Minimum switching current	20 A (15 ms)
Maximum shutdown power (ohmic load)	1 mA
Minimum switching power	2500 VA
	For additional data, see diagram on page 5
	5 mW

<b>General Data</b>	
Test voltage:	Winding/contact Contact/contact
Ambient temperature	2 kV, 50 Hz, 1 minute
Nominal operating mode	2 kV, 50 Hz, 1 minute
Mechanical service life	-55°C to +70°C (-67°F to +158°F)
Electrical service life	100% ED
Standards/specifications	5 x 10 <sup>7</sup> cycles
Approvals	See diagram on page 5
Mounting position/mounting	IEC 60 664/IEC 60 664 A/DIN VDE 0110, degree of pollution 2, Surge Voltage Category II
	UL; CSA; VDE
	Any/can be mounted without spacing

Type	Order No.	Pcs. Pkt.
REL-IR/LDP-12DC/2x21	28 34 01 2	10
REL-IR/LDP-24DC/2x21	28 34 02 5	10
REL-IR/LDP-48DC/2x21	28 34 03 8	10
REL-IR/LDP-110DC/2x21	28 34 04 1	10
REL-IR/LDM-12DC/2x21	28 34 15 1	10
REL-IR/LDM-24DC/2x21	28 34 16 4	10
REL-IR/LDM-48DC/2x21	28 34 17 7	10
REL-IR/LDM-110DC/2x21	28 34 18 0	10
REL-IR/L-24AC/2x21	28 34 05 4	10
REL-IR/L-120AC/2x21	28 34 06 7	10
REL-IR/L-230AC/2x21	28 34 07 0	10

<sup>1)</sup>Further voltage versions, lockable test key, etc. on request.

# Plug-In Industrial Relays With 4PDT Contacts, Suitable for PR2 Relay Base

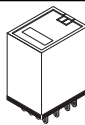
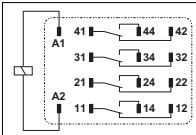
Description	Type	Order No.	Pcs. Pkt.																								
<p><b>Plug-in industrial relays<sup>1)</sup> with power contacts and solid gold coating, 4PDT contacts</b>, test key, status LED, free-wheeling diode, mechanical switch setting display, polarity: <b>A1 +, A2 -</b>            Coil voltage:            - 12 V DC            - 24 V DC            - 48 V DC            - 110 V DC</p>  <p><b>Plug-in industrial relays<sup>1)</sup> with power contacts and solid gold coating, 4PDT contacts</b>, test key, status LED, free-wheeling diode, mechanical switch setting display, polarity: <b>A1 -, A2 +</b> (Japanese standard)            Coil voltage:            - 12 V DC            - 24 V DC            - 48 V DC            - 110 V DC</p>  <p>Representation without LED and free-wheeling diode.</p> <p><b>Plug-in industrial relays<sup>1)</sup> with power contacts and solid gold coating, 4PDT contacts</b>, test key, status LED, mechanical switch setting display            Coil voltage:            - 24 V AC            - 120 V AC            - 230 V AC</p>	<p><b>REL-IR/LDP-12DC/4x21AU</b>  <b>REL-IR/LDP-24DC/4x21AU</b>  <b>REL-IR/LDP-48DC/4x21AU</b>  <b>REL-IR/LDP-110DC/4x21AU</b></p> <p><b>REL-IR/LDM-12DC/4x21AU</b>  <b>REL-IR/LDM-24DC/4x21AU</b>  <b>REL-IR/LDM-48DC/4x21AU</b>  <b>REL-IR/LDM-110DC/4x21AU</b></p> <p><b>REL-IR/L-24AC/4x21AU</b>  <b>REL-IR/L-120AC/4x21AU</b>  <b>REL-IR/L-230AC/4x21AU</b></p>	<p><b>28 34 08 3</b>  <b>28 34 09 6</b>  <b>28 34 10 6</b>  <b>28 34 11 9</b></p> <p><b>28 34 19 3</b>  <b>28 34 20 3</b>  <b>28 34 21 6</b>  <b>28 34 22 9</b></p> <p><b>28 34 12 2</b>  <b>28 34 13 5</b>  <b>28 34 14 8</b></p>	<p>10 10 10 10</p> <p>10 10 10 10</p> <p>10 10 10</p>																								
<p><b>Technical Data</b></p>																											
<p><b>Coil Side DC Coils</b>            Nominal input voltage <math>U_N</math>            Permissible range (with reference to <math>U_N</math>)            Typical input current at <math>U_N</math>            Typical response time at <math>U_N</math>            Typical release time at <math>U_N</math>            DC coil resistance at 20°C (68°F)</p>	<table border="1"> <thead> <tr> <th>12 V DC</th> <th>24 V DC</th> <th>48 V DC</th> <th>110 V DC</th> </tr> </thead> <tbody> <tr> <td>See diagram on page 5</td> <td>See diagram on page 5</td> <td>See diagram on page 5</td> <td>See diagram on page 5</td> </tr> <tr> <td>75 mA</td> <td>38 mA</td> <td>19 mA</td> <td>10 mA</td> </tr> <tr> <td>13 ms</td> <td>13 ms</td> <td>13 ms</td> <td>13 ms</td> </tr> <tr> <td>5 ms</td> <td>5 ms</td> <td>5 ms</td> <td>5 ms</td> </tr> <tr> <td>160 Ω ±15%</td> <td>630 Ω ±15%</td> <td>2560 Ω ±15%</td> <td>11100 Ω ±15%</td> </tr> </tbody> </table>			12 V DC	24 V DC	48 V DC	110 V DC	See diagram on page 5	See diagram on page 5	See diagram on page 5	See diagram on page 5	75 mA	38 mA	19 mA	10 mA	13 ms	13 ms	13 ms	13 ms	5 ms	5 ms	5 ms	5 ms	160 Ω ±15%	630 Ω ±15%	2560 Ω ±15%	11100 Ω ±15%
12 V DC	24 V DC	48 V DC	110 V DC																								
See diagram on page 5	See diagram on page 5	See diagram on page 5	See diagram on page 5																								
75 mA	38 mA	19 mA	10 mA																								
13 ms	13 ms	13 ms	13 ms																								
5 ms	5 ms	5 ms	5 ms																								
160 Ω ±15%	630 Ω ±15%	2560 Ω ±15%	11100 Ω ±15%																								
<p><b>Coil Side AC Coils (50 Hz/60 Hz)</b>            Nominal input voltage <math>U_N</math>            Permissible range (with reference to <math>U_N</math>)            Typical input current at <math>U_N</math> (50 Hz/60 Hz)            Typical response time at <math>U_N</math> (depending on phase relation)            Typical release time at <math>U_N</math> (depending on phase relation)            DC coil resistance at 20°C (68°F)</p>	<table border="1"> <thead> <tr> <th>24 V AC</th> <th>120 V AC</th> <th>230 V AC</th> </tr> </thead> <tbody> <tr> <td>See diagram on page 5</td> <td>See diagram on page 5</td> <td>See diagram on page 5</td> </tr> <tr> <td>54 mA/46 mA</td> <td>11 mA/9 mA</td> <td>5 mA/4 mA</td> </tr> <tr> <td>4 - 10 ms</td> <td>4 - 10 ms</td> <td>4 - 10 ms</td> </tr> <tr> <td>3 - 12 ms</td> <td>3 - 12 ms</td> <td>3 - 12 ms</td> </tr> <tr> <td>180 Ω ±15%</td> <td>4430 Ω ±15%</td> <td>18790 Ω ±15%</td> </tr> </tbody> </table>			24 V AC	120 V AC	230 V AC	See diagram on page 5	See diagram on page 5	See diagram on page 5	54 mA/46 mA	11 mA/9 mA	5 mA/4 mA	4 - 10 ms	4 - 10 ms	4 - 10 ms	3 - 12 ms	3 - 12 ms	3 - 12 ms	180 Ω ±15%	4430 Ω ±15%	18790 Ω ±15%						
24 V AC	120 V AC	230 V AC																									
See diagram on page 5	See diagram on page 5	See diagram on page 5																									
54 mA/46 mA	11 mA/9 mA	5 mA/4 mA																									
4 - 10 ms	4 - 10 ms	4 - 10 ms																									
3 - 12 ms	3 - 12 ms	3 - 12 ms																									
180 Ω ±15%	4430 Ω ±15%	18790 Ω ±15%																									
<p><b>Contact Side</b>            Contact type            Contact material            Maximum switching voltage            Minimum switching voltage            Limiting continuous current            Maximum inrush current            Minimum switching current            Maximum shutdown power (ohmic load)            Minimum switching power</p>	<p><b>REL-IR...4x21AU</b>            Single contact, 4 PDT contacts            AgNi + 3 μ Au            250 V AC/125 V DC            1 V            5 A            12 A (15 ms)            1 mA            1250 VA            For additional data, see diagram on page 5            1 mW</p>																										
<p><b>General Data</b>            Test voltage: Winding/contact                              Contact/contact            Ambient temperature            Nominal operating mode            Mechanical service life            Electrical service life            Standards/specifications            Approvals            Mounting position/mounting</p>	<p>2 kV, 50 Hz, 1 minute            2 kV, 50 Hz, 1 minute            -55°C to +70°C (-67°F to +158°F)            100% ED            5 x 10<sup>7</sup> cycles            See diagram on page 5            IEC 60 664/IEC 60 664 A/DIN VDE 0110,            degree of pollution 2, Surge Voltage Category II            UL; CSA; VDE            Any/can be mounted without spacing</p>																										

<sup>1)</sup>Further voltage versions, lockable test key, etc. on request.

# Diagrams for REL-IR... Industrial Relays

## REL-IR...2x21 (DPDT Contacts)

Operating voltage range

$$T_u = T_{coil}$$

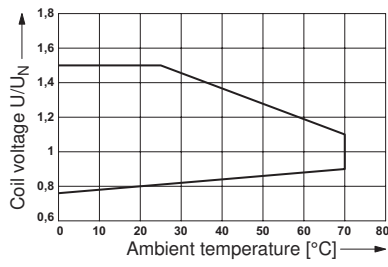

Shutdown power

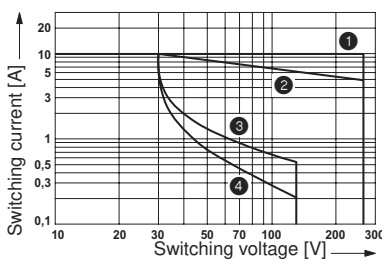

- ① AC, ohmic load
- ② AC,  $\cos \varphi = 0.4$
- ③ DC, ohmic load
- ④ DC,  $L/R = 7$  ms

Electrical service life

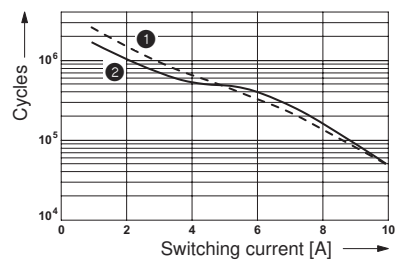

- ① 250 V AC, ohmic load
- ② 30 V DC, ohmic load

## REL-IR...4x21AU (4PDT Contacts)

Operating voltage range

$$T_u = T_{coil}$$

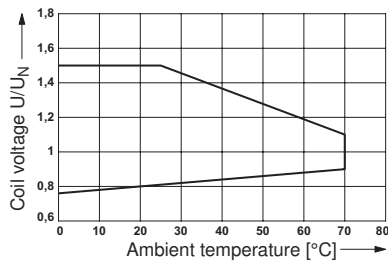

Shutdown power

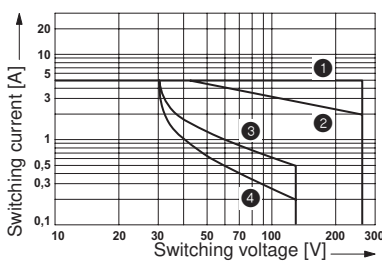

- ① AC, ohmic load
- ② AC,  $\cos \varphi = 0.4$
- ③ DC, ohmic load
- ④ DC,  $L/R = 7$  ms

Electrical service life

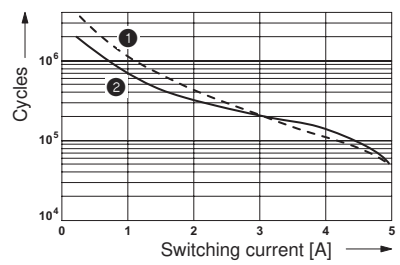

- ① 250 V AC, ohmic load
- ② 30 V DC, ohmic load