



Chipsmall Limited consists of a professional team with an average of over 10 year of expertise in the distribution of electronic components. Based in Hongkong, we have already established firm and mutual-benefit business relationships with customers from,Europe,America and south Asia,supplying obsolete and hard-to-find components to meet their specific needs.

With the principle of “Quality Parts,Customers Priority,Honest Operation,and Considerate Service”,our business mainly focus on the distribution of electronic components. Line cards we deal with include Microchip,ALPS,ROHM,Xilinx,Pulse,ON,Everlight and Freescale. Main products comprise IC,Modules,Potentiometer,IC Socket,Relay,Connector.Our parts cover such applications as commercial,industrial, and automotives areas.

We are looking forward to setting up business relationship with you and hope to provide you with the best service and solution. Let us make a better world for our industry!



Contact us

Tel: +86-755-8981 8866 Fax: +86-755-8427 6832

Email & Skype: info@chipsmall.com Web: www.chipsmall.com

Address: A1208, Overseas Decoration Building, #122 Zhenhua RD., Futian, Shenzhen, China



IB IL AO 1/U/SF

INTERBUS Inline Terminal With One Analog Voltage Output

Data Sheet 5736CC01

05/2001

5736A001

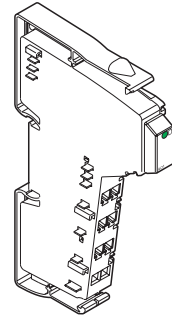

This data sheet is intended to be used in conjunction with the “Configuring and Installing the INTERBUS Inline Product Range“ user manual IB IL SYS PRO UM E.

Function

This terminal is used to output analog voltage signals. The signals are available with 16 bit resolution.

Features

- One analog signal output to connect voltage outputs
- Actuator connection (using 2-wire technology and shield connection)
- Voltage range: 0 V to 10 V
- Process data update including conversion time of the digital/analog converter < 1 ms

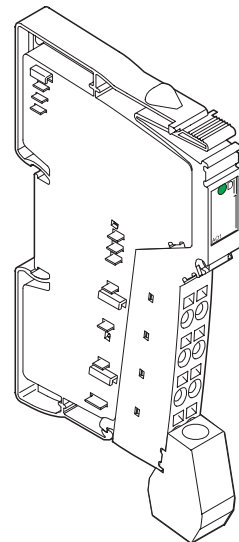

5736A007

Figure 1 IB IL AO 1/U/SF terminal with the connector plugged in



Please note that the connector is not supplied with the terminal. Refer to the “Ordering Data” Table at the end of this data sheet to choose the appropriate connector for your application.

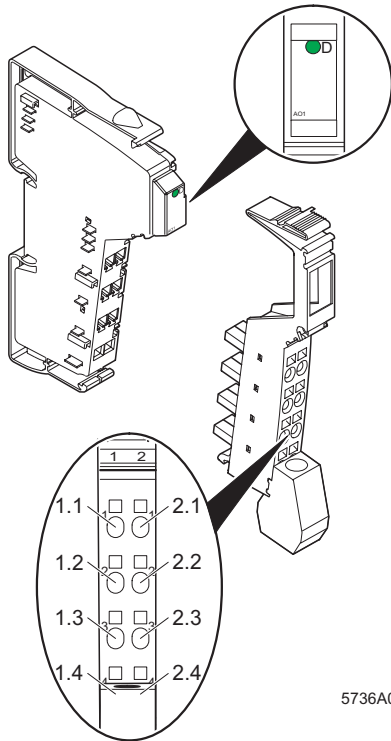

5736A002

Figure 2 IB IL AO 1/U/SF terminal with the appropriate connector

Local Diagnostic and Status Indicators

Des.	Color	Meaning
D	Green	Bus diagnostics

Terminal Assignment

Terminal Point	Signal	Assignment
1.1	U	Voltage output 0 V to 10 V
2.1	–	Not used
1.2, 2.2	–	Not used
1.3, 2.3	GND	Ground
1.4, 2.4	Shield	Shield connection

Installation Instruction

High current flowing through the voltage jumpers U_M and U_S leads to a temperature rise of the voltage jumpers and the inside of the terminal. Note the following instruction to keep the current flowing through the voltage jumpers of the analog terminals as low as possible:



All of the analog terminals need a separate main circuit!

If this is not possible in your application and if you are using analog terminals in a main circuit together with other terminals, make sure you are placing the analog terminals behind all the other terminals at the end of the main circuit.

Please note the derating curve on page 12.

Internal Circuit Diagram

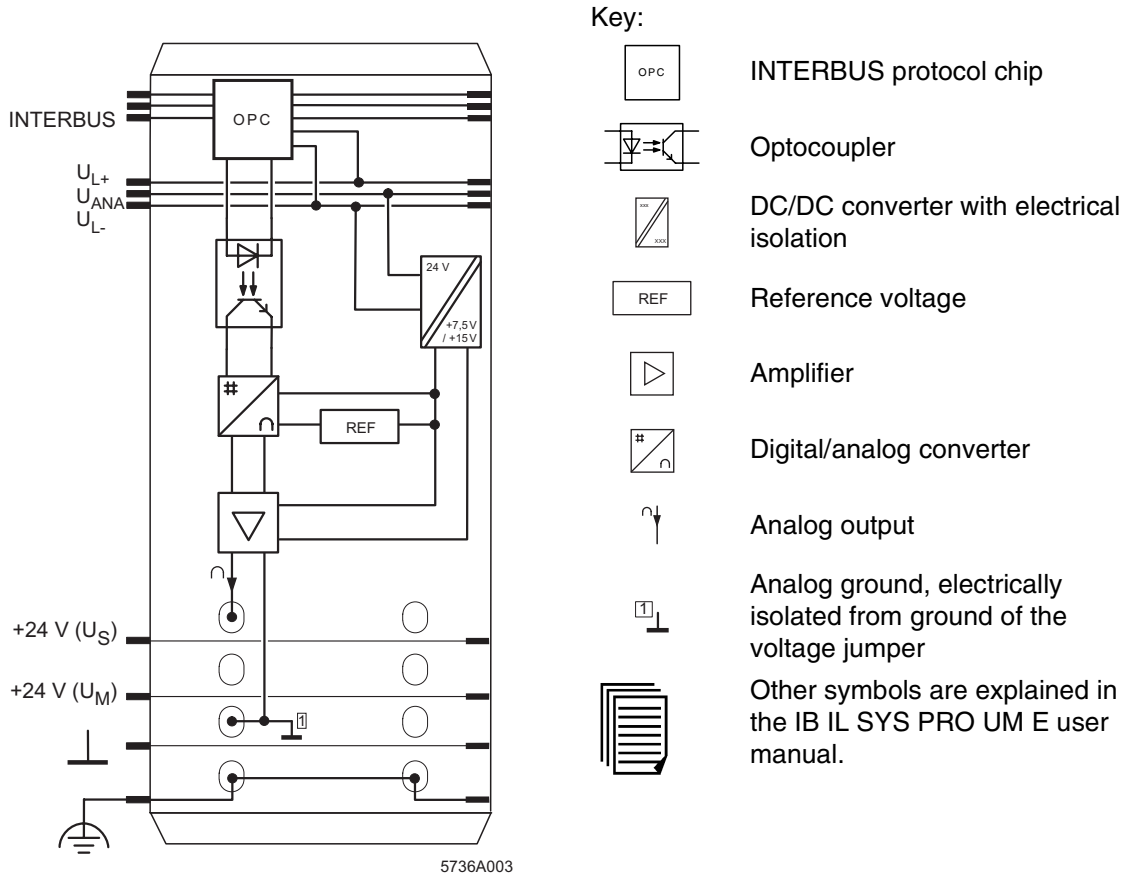

Figure 3 Internal wiring of the terminal points

Electrical Isolation

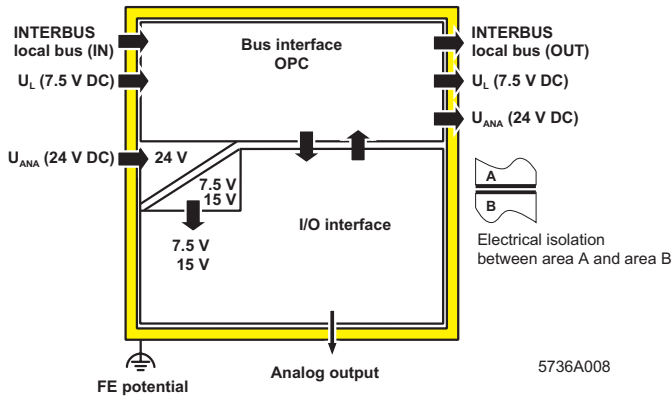

Figure 4 Electrical isolation of the function areas

Connection



Always connect the analog actuator using shielded, twisted-pair cables.

Connect one end of the shielding to protective earth ground (PE). At the module, fold the outer cable sheath back and connect the shield to the terminal via the shield connector clamp. The clamp connects the shield directly to FE (functional earth ground) on the module side.



When using cables longer than 10 m (32.8 ft.) in environments with heavy noise, we recommend connecting the shield through an RC element to the FE potential of the actuator. Typically, the capacitor C should be rated between 1 and 15 nF. The resistor R should be at least 10 MW .

Connection Example



Use a connector with shield connection when installing the actuator. Figure 5 shows the connection schematically (without shield connector).

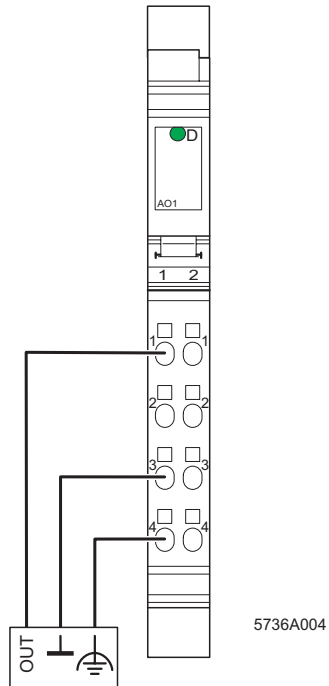

Figure 5 Typical actuator connection (using 2-wire technology and shield connection)

Programming Data

ID code	7D _{hex} (125 _{dec})
Length code	01 _{hex}
Input address area	0 bytes
Output address area	2 bytes
Parameter channel (PCP)	0 bytes
Register length (bus)	2 bytes

INTERBUS Process Data Words



The process data input word is not used.

Assignment of the Terminal Points to the Process Data Output Word

INTERBUS reference	Word	Word x															
	Bit	15	14	13	12	11	10	9	8	7	6	5	4	3	2	1	0
"Byte-bit" view	Byte	Byte 0								Byte 1							
	Bit	7	6	5	4	3	2	1	0	7	6	5	4	3	2	1	0
Terminal points	Signal	Terminal point 1.1: Voltage output															
	Signal reference	Terminal point 1.3															
	Shield (FE)	Terminal point 1.4															

INTERBUS OUT Process Data Output Words

The process data output word specifies the output value in each cycle.

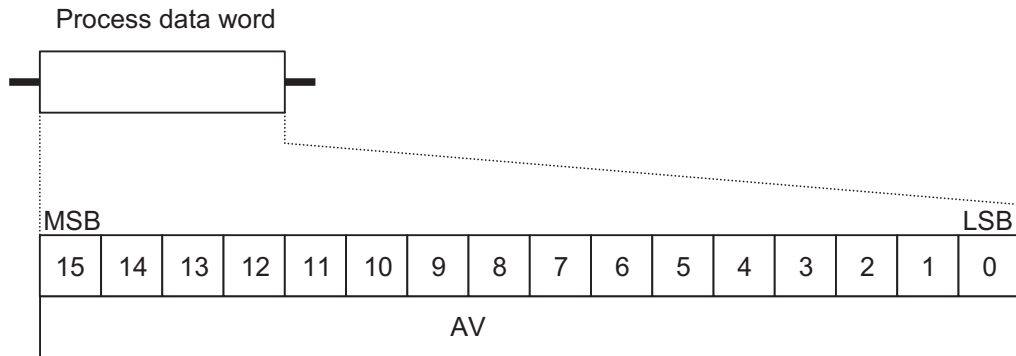

55620006

Figure 6 Process data output word

AV Analog value

MSB Most Significant Bit

LSB Least Significant Bit

All output values are displayed with 16 bit resolution.

Significant Values in the Process Data Word

INTERBUS OUT Process Data Word for the Voltage Output 0 V to 10 V (Example)																		
Voltage output 0 V to 10 V	Analog value (V)	Process data word																
		Hex.	Binary (two's complement)															
			MSB	15	14	13	12	11	10	9	8	7	6	5	4	3	2	1
10 V minus 1 QS	9.99985	FFFF	1	1	1	1	1	1	1	1	1	1	1	1	1	1	1	1
10 V minus 2 QS	9.99969	FFFE	1	1	1	1	1	1	1	1	1	1	1	1	1	1	1	0
Half FVOR	5.0000	8000	1	0	0	0	0	0	0	0	0	0	0	0	0	0	0	0
1 QS	0.153 mV	0001	0	0	0	0	0	0	0	0	0	0	0	0	0	0	0	1
Zero	0.0000	0000	0	0	0	0	0	0	0	0	0	0	0	0	0	0	0	0

Abbreviations used:

- QS Quantization Step(s)
- MSB Most Significant Bit
- FVOR Final Value of the Output Range
- LSB Least Significant Bit

Output Behavior of the Voltage Output



Take output behavior (in the event of an error) into account when planning your system!

Switching Operation/ State of the Supply Voltage	Marginal Conditions	INTERBUS OUT Process Data Word (hexadecimal)	Behavior/Status of the Analog Output
U_{ANA} from 0 V to 24 V	$U_L = 0$ V	xxxx	0 V
U_{ANA} from 24 V to 0 V	$U_L = 7.5$ V	xxxx	0 V
Bus in stop state	$U_{ANA} = 0$ V	xxxx	0 V
Bus in stop state	$U_{ANA} = 24$ V	xxxx	0 V or keep last value

U_{ANA} Analog supply voltage of the terminal

U_L Supply voltage of the module electronics (logic supply)

xxxx Any value ranging from 0000_{hex} to FFFF_{hex}.

Response of the Control System or Computer to a Hardware Signal for Different Control or Computer Systems



Signal	Control or Computer System	Status After the Switching Operation	
		INTERBUS OUT Process Data Word	Analog Output
			U_{out}
NORM*	Schneider Automation	0000	0 V
BASP	Siemens S5	0000	0 V
CLAB	Bosch	0000	0 V
SYSFAIL	VME	0000	0 V
SYSFAIL	PC	0000	0 V
CLEAR OUT	Moeller IPC	0000	0 V

* On controller boards for Schneider Automation control systems it is possible to set the NORM signal in such a way that the INTERBUS OUT process data word and the analog output keep the last value.

Response of the Voltage Output to a Control Command of the INTERBUS Controller Board

Command	Status After the Switching Operation	
	INTERBUS OUT Process Data Word	Analog Output
		U_{out}
STOP	Keep last value	Keep last value
ALARM STOP (reset)	Keep last value	Keep last value

Technical Data

General	
Housing dimensions (width x height x depth)	12.2 mm x 120 mm x 71.5 mm (0.480 in. x 4.724 in. x 2.795 in.)
Weight	46 g (without connector)
Operating mode	Process data operation with 1 word
Connection type of the actuators	2-wire technology
Permissible temperature (operation)	-25°C to +55°C (-13°F to +131°F)
Permissible temperature (storage/transport)	-25°C to +85°C (-13°F to +185°F)
Permissible humidity (operation)	75% on average, 85% occasionally
 Ranging from -25°C to +55°C (-13°F to +131°F). Appropriate measures against increased humidity (> 85%) must be taken.	
Permissible humidity (storage/transport)	75% on average, 85% occasionally
 For a short period, slight condensation may appear on the housing if, for example, the terminal is brought into a closed room from a vehicle.	
Permissible air pressure (operation)	80 kPa to 106 kPa (up to 2000 m [6562 ft.] above sea level)
Permissible air pressure (storage/transport)	70 kPa to 106 kPa (up to 3000 m [9843 ft.] above sea level)
Degree of protection	IP 20 according to IEC 60529
Class of protection	Class 3 according to VDE 0106, IEC 60536

Deviations From Common Technical Data That Is Indicated in the IB IL SYS PRO UM E User Manual

Mechanical Demands	
Shock test according to IEC 60068-2-27	15g load for 11 ms, half sinusoidal wave, three shocks in each space direction and orientation. 25g load for 6 ms, half sinusoidal wave, three shocks in each space direction and orientation.

Interface

INTERBUS interface	Data routing
--------------------	--------------

Power Consumption	
Communications Power U_L	7.5 V
Current consumption from U_L (local bus)	Approx. 30 mA, typical; 40 mA, maximum
I/O supply voltage U_{ANA}	24 V DC
Current consumption of U_{ANA}	15 mA, typical; 20 mA, maximum
Total power consumption	Approx. 585 mW, typical

Supply of the Module Electronics and I/O Through Bus Terminal/Power Terminal	
Connection method	Potential routing

Derating: Permissible ambient temperature depending on the current of the voltage jumpers U_M and U_S (total current)

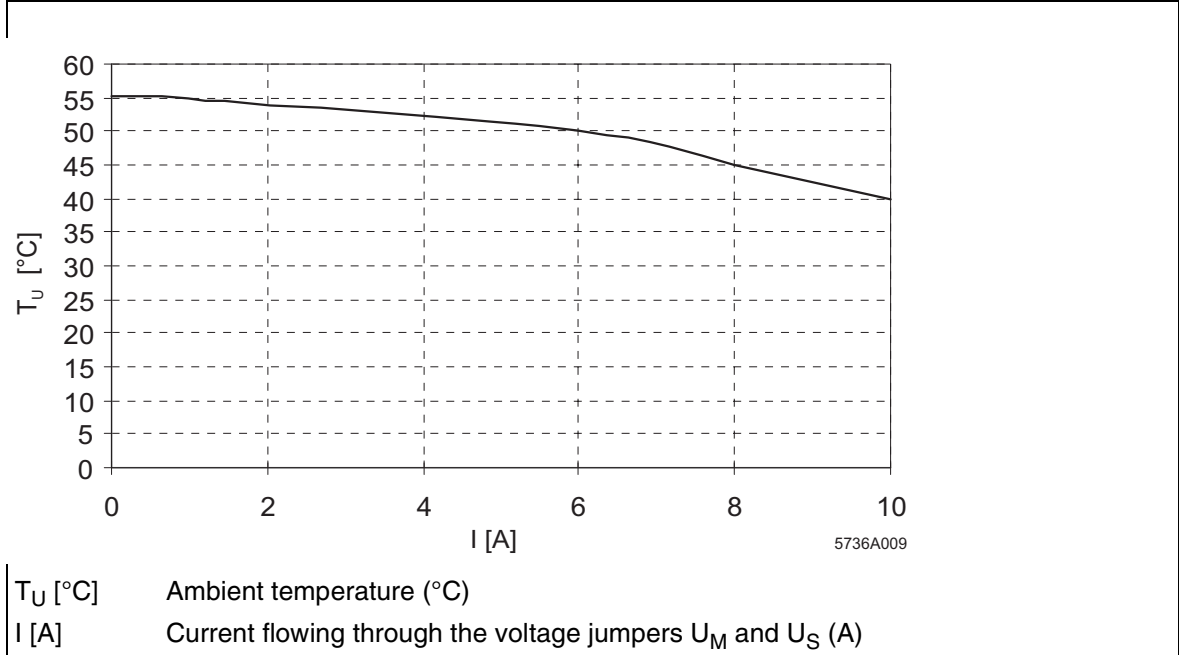

Analog Output			
Number	1		
Signals/resolution in the process data word (quantization)	0 to 9.99985 V 0.153 mV/LSB		
Voltage	0 to 10 V	0 to 9.99985 V	0.153 mV/LSB
Measuring value representation	16 bits straight binary		
Basic error limit	±0.05%, typical		
Output load	2 kΩ, minimum		
Process data update including the conversion time of the digital/analog converter	1 INTERBUS cycle (depending on the bus configuration); < 1 ms		
Slew rate (> 99% of the final value)	< 10 μs		

Tolerance and Temperature Response of the Voltage Output (The error indications refer to the output range final value of 10 V.)		
	Typical	Maximum
Error at 23°C (73.4°F)		
Total offset voltage	±0.03%	±0.05%
Gain error	±0.10%	±0.15%
Differential non-linearity	±0.0012%	±0.003%
Total error at 23°C (73.4°F)	±0.15%	±0.25%
Temperature response at -25°C to 55°C (-13°F to 131°F)		
Offset voltage drift T_{KVO}	±10 ppm/K	±65 ppm/K
Gain drift T_{KG}	±30 ppm/K	±35 ppm/K
Total voltage drift $T_{Ktot} = T_{KVO} + T_{KG}$	±40 ppm/K	±100 ppm/K
Total error of the voltage output (-25°C to 55°C [-13°F to 131°F]) Offset error + gain error + linearity error + drift error	±0.30%	±0.60%

Additional tolerances influenced by electromagnetic fields		
Type of electromagnetic interference	Criterion	Typical, relative deviation of the measuring range final value
Electromagnetic fields Field strength 10 V/m acc. to IEC 61000-4-3	A	< 1%
Fast transients Supply 2 kV, output 1 kV acc. to IEC 61000-4-4	B	< 1%
Conducted interference Class 3 (test voltage 10 V) acc. to IEC 61000-4-6	A	< 6%

Safety Devices	
None	

Electrical Isolation	
	The DC/DC converter ensures electrical isolation between the logic level and the I/O area.
Common potentials	
24 V I/O voltage, 24 V segment voltage, and GND have the same potential. FE (functional earth ground) is a separate potential area.	
Separate system potentials consisting of bus terminal/power terminal and I/O terminal	
- Test distance	- Test voltage
7.5 V supply (bus logic) / 24 V supply U_{ANA} / I/O	500 V AC, 50 Hz, 1 min.
7.5 V supply (bus logic) / 24 V supply U_{ANA} / functional earth ground	500 V AC, 50 Hz, 1 min.
24 V supply (I/O) / functional earth ground	500 V AC, 50 Hz, 1 min.

Error Messages to the Higher-Level Control or Computer System	
Breakdown or dropping of communications power U_L	Yes, I/O error message to the bus terminal

Ordering Data

Description	Order Designation	Order No.
Terminal with one analog voltage output	IB IL AO 1/U/SF	27 27 77 6
 You need 1 connector (total) for the AO 1/U/SF terminal.		
I/O connector with six terminals using spring-cage method and shield connection (green, w/o color print), pack of 5	IB IL SCN-6 SHIELD	27 26 35 3
“Configuring and Installing the INTERBUS Inline Product Range“ user manual”	IB IL SYS PRO UM E	27 43 04 8

Phoenix Contact GmbH & Co. KG
Flachsmarktstr. 8
32825 Blomberg
Germany

 + 49 - (0) 52 35 - 3-00

 + 49 - (0) 52 35 - 3-4 12 00

 www.phoenixcontact.com