



Chipsmall Limited consists of a professional team with an average of over 10 year of expertise in the distribution of electronic components. Based in Hongkong, we have already established firm and mutual-benefit business relationships with customers from,Europe,America and south Asia,supplying obsolete and hard-to-find components to meet their specific needs.

With the principle of “Quality Parts,Customers Priority,Honest Operation,and Considerate Service”,our business mainly focus on the distribution of electronic components. Line cards we deal with include Microchip,ALPS,ROHM,Xilinx,Pulse,ON,Everlight and Freescale. Main products comprise IC,Modules,Potentiometer,IC Socket,Relay,Connector.Our parts cover such applications as commercial,industrial, and automotives areas.

We are looking forward to setting up business relationship with you and hope to provide you with the best service and solution. Let us make a better world for our industry!



Contact us

Tel: +86-755-8981 8866 Fax: +86-755-8427 6832

Email & Skype: info@chipsmall.com Web: www.chipsmall.com

Address: A1208, Overseas Decoration Building, #122 Zhenhua RD., Futian, Shenzhen, China



TRIO-UPS/1AC/24DC/5

Uninterruptible power supply with integrated power supply unit

INTERFACE

Data sheet
104103_en_00

© PHOENIX CONTACT - 2009-09-01



1 Description

The TRIO-UPS/1AC/24DC/5 provides an uninterruptible 24 V DC voltage at a maximum load current of up to 5 A in both an error-free AC power supply network and in the event of power failure.

It is designed specifically for supplying industrial PCs (IPC).

The power supply unit and the electronic switch-over unit are housed in the same housing.

In the event of supply voltage failure, buffer mode is activated without interruption. In this operating mode, the output voltage is directly dependent on the battery voltage. In the event of a voltage dip, the IPC continues operating without interruption, thus increasing system availability. Uncontrolled shutdown is avoided.

The TRIO-UPS/1AC/24DC/5 can be parameterized using a service PC and the UPS-CONF configuration and management software via an IFS-USB-PROG-ADAPTER.

For convenient parameter transfer between various TRIO-UPS devices, the IFS-CONFSTICK configuration stick is available as an option.

Features

- Space-saving
The TRIO-UPS combines a power supply unit and electronic switch-over unit in the same housing
- Flexible
Rechargeable battery module with 1.3, 3.4, 7.2 or 12 Ah
- Autonomous
In the event of AC mains failure, the industrial PC continues operating without interruption
- Time-saving
When the supply voltage is reapplied, the industrial PC starts automatically
- Parameterizable
Can be parameterized with the PC or configuration stick



DANGER

Never carry out work when voltage is present.

The device contains dangerous live elements and high levels of stored energy.

Depending on the ambient temperature and load, the housing can become very hot.



Make sure you always use the latest documentation.

It can be downloaded at www.phoenixcontact.net/download.



This data sheet is valid for all products listed under "Ordering data" on page 3.

2 Table of contents

1	Description.....	1
2	Table of contents	2
3	Ordering data.....	3
4	Technical data	3
4.1	I/O data.....	3
4.2	Battery management	4
4.3	Signaling and switching outputs	5
4.4	Ambient conditions.....	5
4.5	Standards/approvals	6
5	Safety regulations	7
6	Connection, operating, and indication elements	8
6.1	Connection terminal blocks	8
6.2	Block diagram	9
6.3	Input	9
6.4	Output	10
6.5	LED indicators.....	10
7	Installation	11
7.1	Narrow mounting position.....	11
7.2	Flat mounting position	11
8	Rechargeable battery module.....	12
9	Method of operation.....	13
9.1	Output voltage	13
9.2	Remote shutdown	13
9.3	Buffer time setting	13
9.4	PC mode	13
9.5	PC idle time	14
9.6	Battery management.....	15
10	Interfaces.....	15
10.1	Config.-Port	15
10.2	IFS-USB-PROG-ADAPTER	15
10.3	IFS-CONFSTICK.....	15
11	UPS-CONF configuration and management software	16

3 Ordering data

UPS system

Description	Type	Order No.	Pcs./Pkt.
Uninterruptible power supply with integrated power supply unit	TRIO-UPS/1AC/24DC/5	2866611	1



The TRIO-UPS/1AC/24DC/5 is supplied without a rechargeable battery module. The rechargeable battery module must be ordered separately (see accessories).

Accessories

Description	Type	Order No.	Pcs./Pkt.
Rechargeable battery module, 24 V DC, 1.3 Ah	MINI-BAT/24DC/1.3AH	2866417	1
Rechargeable battery module, 24 V DC, 3.4 Ah	QUINT-BAT/24DC/3.4AH	2866349	1
Rechargeable battery module, 24 V DC, 7.2 Ah	QUINT-BAT/24DC/7.2AH	2866352	1
Rechargeable battery module, 24 V DC, 12 Ah	QUINT-BAT/24DC/12AH	2866365	1
Configuration and management software	UPS-CONF	2320403	1
USB data link cable between the UPS and IPC	IFS-USB-PROG-ADAPTER	2811271	1
Configuration stick for parameter transfer between various TRIO-UPS/1AC/24DC/5 devices	IFS-CONFSTICK	2986122	1

4 Technical data

4.1 I/O data

Input data	
Nominal input voltage (wide-range input)	100 ... 240 V AC
Input voltage range (nominal load)	85 ... 264 V AC (< 90 V AC derating: 2.5%/V) 100 ... 350 V DC (UL508: 100 ... 250 V)
Frequency	45 ... 65 Hz
Approximate current consumption (mains operation and battery charging/ maximum)	
At 230 V AC	0.95 A/1.1 A
At 120 V AC	1.7 A/1.8 A
Inrush current limiting / I ² t at 25°C	typical < 44 A / < 1.3 A ² s
Switch-on time after applying the mains voltage	
At 230 V AC	150 ms
At 120 V AC	200 ms
Transient surge protection	Varistor
Internal input fuse	T 6.3 A
Recommended backup fuse	
Circuit breaker	6 A/10 A/16 A (B characteristic)
Discharge current to PE	0.8 mA
Output data	
Rise time	< 100 ms
Residual ripple	< 10 mV _{PP}
Switching peaks	< 25 mV _{PP}
Parallel connection to increase the buffer time	Yes, 2
Surge protection against internal surge voltages	Yes, < 35 V DC
Maximum resistance to return supply	35 V DC

Output data in mains operation (AC input voltage present)

Nominal output voltage U_N	24 V DC
Output voltage (adjustable)	22.5 ... 29.5 V DC
Nominal output current, > 24 V DC constant capacity (-25°C to +70°C)	5 A
Derating (above 55°C)	2.5%/K
Current limit	6 A, approximately
Connection of capacitive loads	Yes, unlimited
Control deviation	< 1% (static load change 10 ... 90%)
Approximate efficiency (mains operation and battery charging)	
At 230 V AC	88%
At 120 V AC	86%
Approximate power dissipation (mains operation and battery charging)	
At 230 V AC	16 W
At 120 V AC	20 W

Output data in battery operation (AC input voltage not present)

Nominal output voltage U_N	24 V DC
Output voltage ($U_{OUT} = U_{BAT} - 0.5 V$)	27.9 ... 19.2 V DC - 0.5 V
Nominal output current (-25°C to +70°C)	5 A
Derating (above 55°C)	2.5%/K
Current limit	6 A, approximately
Connection of capacitive loads	Yes, 3300 μ F
Efficiency	> 86%
Power dissipation	
Maximum no load	2 W
Maximum nominal load	4 W
Maximum buffer time (adjustable per minutes)	0.5; 1; 2; 3; 5; 10; 15; 20; PC mode
Overload fuse (electronic)	Yes
Remote shutdown	Yes

4.2 Battery management**Battery management**

Charging characteristic curve	I/U
Charging current ¹ (preset/minimum/maximum)	1.0 A/0.2 A/1.5 A
End-of-charge voltage ¹ (preset/minimum/maximum)	27,6 V DC / 25 V DC / 30 V DC
Temperature compensation ¹ (preset/minimum/maximum)	42 mV/K / 0 mV/K / 200 mV/K
Battery presence check/time interval	60 s
Battery quality check ¹ (preset/minimum/maximum)	12 h/4 h/200 h
Protection against total discharge ¹ (preset/minimum/maximum)	19.2 V DC / 18 V DC / 21 V DC
"Battery almost flat" alarm signaling threshold ¹ (preset/minimum/maximum)	20.4 V DC / 18 V DC / 30 V DC

¹ Can be adjusted via UPS-CONF software

4.3 Signaling and switching outputs

Status indicators

Mains voltage OK (Power in OK)	Green LED, static ON
Alarm	
LED indicator	Red LED, static ON
Switching output	24 V DC, active high
Current limit (internal)	200 mA
Battery operation (Battery Mode)	
LED indicator	Yellow LED, static ON
Switching output	24 V DC, active high
Current limit (internal)	200 mA
Signal options ¹	Bat.-Mode, Bat.-Mode Delayed
Battery charging (Battery Charge)	
LED indicator	Yellow LED, flashing
Switching output	24 V DC, active high
Current limit (internal)	200 mA
Signal options ¹	Bat.-Charge, Bat.-Mode, Bat.-Mode Delayed, battery almost flat

¹ Can be adjusted via UPS-CONF software

4.4 Ambient conditions

Climatic requirements

Ambient temperature	
Operation (> 55°C derating)	-25°C ... +70°C
Storage/transport	-40°C ... +80°C
Humidity at +25°C, no condensation	95%
Pollution degree according to EN 50178	2
Climatic class	3K3

Mechanical requirements



Vibration (operation)	< 15 Hz, amplitude ±2.5 mm according to IEC 60068-2-6 15 Hz ... 150 Hz, 2.3g, 90 min.
Shock according to IEC 60068-2-27	30g in each direction

General data

Insulation voltage I/O (type/routine test)	4 kV AC/2 kV AC
Input/PE (type/routine test)	2 kV AC/2 kV AC
Output/PE (routine test)	500 V DC
Mounting position according to	EN 60715
Degree of protection	IP20
Protection class (with PE connection)	I
MTBF according to IEC 61709 (SN 29500)	> 500,000 h
Material	Aluminum (AlMg3)/zinc-plated sheet steel
Dimensions (W/H/D)	60 mm x 130 mm x 118 mm
Weight	1.1 kg

4.5 Standards/approvals

Standards/approvals

Electrical equipment of machines (surge voltage category III)	EN 60204
Safety transformers for switched-mode power supply units	IEC 61558-2-17
Electrical safety (of information technology equipment)	EN 60950/VDE 0805 UL/C-UL Recognized UL 60950 
Industrial control equipment	UL/C-UL Listed UL 508 
Electronic equipment for use in power installations	EN 50178 (VDE 0160)
PELV/SELV	PELV (EN 60204)/SELV (IEC 60950)
Safe isolation	VDE 0100-410
Protection against electric shock	DIN 57100-410
Protection against electric shock, basic requirements for safe isolation in electrical equipment	DIN VDE 0106-101
Limitation of mains harmonic currents	EN 61000-3-2

Conformance with EMC Directive 2004/108/EC, noise immunity according to 2006/95/EC (electromagnetic compatibility)

Noise immunity according to EN 61000-6-2			
Electrostatic discharge according to EN 61000-4-2	Housing	Level 3	
	Contact discharge	6 kV	
	Air discharge	8 kV	
	Remark	Criterion B	
Electromagnetic HF field according to EN 61000-4-3	Housing	Level 3	
	Frequency range	80 MHz ... 2 GHz	
	Field strength	10 V/m	
	Remark	Criterion A	
Fast transients (burst) according to EN 61000-4-4	Input	4 kV (Level 4 - asymmetrical: Cable to ground)	
	Output	2 kV (Level 4 - asymmetrical: Cable to ground)	
	Signal	1 kV (Level 4 - asymmetrical: Cable to ground)	
	Remark	Criterion B	
Surge current loads (surge) according to EN 61000-4-5	Input	4 kV (Level 4 - asymmetrical: Cable to ground) 2 kV (Level 4 - asymmetrical: Cable to cable)	
	Output	2 kV (Level 3 - asymmetrical) 1 kV (Level 3 - symmetrical)	
	Signal	2 kV (Level 3 - asymmetrical)	
	Remark	Criterion B	
	Conducted interference according to EN 61000-4-6	Input/output/signal	Level 3
		Frequency range	10 kHz ... 80 MHz
Voltage		10 kV	
Remark		Criterion A	
Noise emission according to EN 61000-6-3	Radio interference voltage according to EN 55011	EN 55011 (EN 55022) Class B, industrial and residential applications	

5 Safety regulations

Installation notes

**NOTE:**

- The device must only be installed, operated, and maintained by qualified personnel.
- Follow the installation instructions.
- When installing and operating the device, the applicable safety directives (including national safety directives), accident prevention regulations, as well as general technical regulations, must be observed.
- For the safety data, please refer to the package slip and certificates (conformity assessment, other approvals, if necessary).
- Do not repair the device yourself, replace it with an equivalent device.
- Repairs may only be carried out by the manufacturer. The manufacturer is not liable for damage resulting from violation.
- The IP20 degree of protection (IEC 60529/ EN 60529) of the device is intended for use in a clean and dry environment.
- The device must not be subject to mechanical strain and/or thermal loads, which exceed the limits described.

Connection notes

**NOTE: Electrostatic discharge**

The device contains components that can be damaged or destroyed by electrostatic discharge. When handling the device, observe the necessary safety precautions against electrostatic discharge (ESD) according to EN 61340-5-1 and EN 61340-5-2.

6 Connection, operating, and indication elements

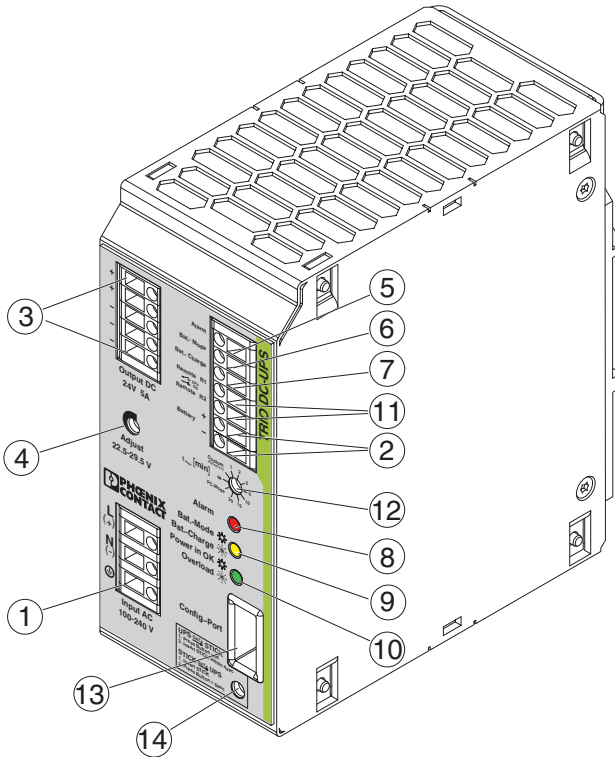

Figure 1 TRIO-UPS/1AC/24DC/5 structure

No.	Description
①	100 ... 240 V AC input
②	24 V rechargeable battery module connection
③	24 V DC output, buffered
④	22.5 ... 29.5 V DC potentiometer
⑤	Active switching output: Alarm
⑥	Active switching output: Bat.-Mode
⑦	Active switching output: Bat.-Charge
⑧	Red LED indicator: Alarm
⑨	Yellow LED indicator: Bat.-Mode/Bat.-Charge
⑩	Green LED indicator: Power in OK/Overload
⑪	Remote shutdown (R1, R2)
⑫	Buffer time setting 0.5 ... 20 minutes, PC mode, unlimited ∞
⑬	Config.-Port
⑭	"Confirm" button

6.1 Connection terminal blocks

Use a screwdriver with the correct blade width for wiring. For reliable and safe-to-touch connections, strip 8 mm off the cable ends.

The following cable cross-sections can be connected:

Terminal block No.	Rigid [mm ²]	Stranded [mm ²]	AWG	Tightening torque	
				[Nm]	[lb in]
① - ③, ⑤ - ⑦, ⑪	0.2 - 2.5	0.2 - 2.5	24 - 12	0.5 - 0.6	3.5 - 4.5



In order to comply with UL approval, use copper cables that are designed for operating temperatures >75°C.

6.2 Block diagram

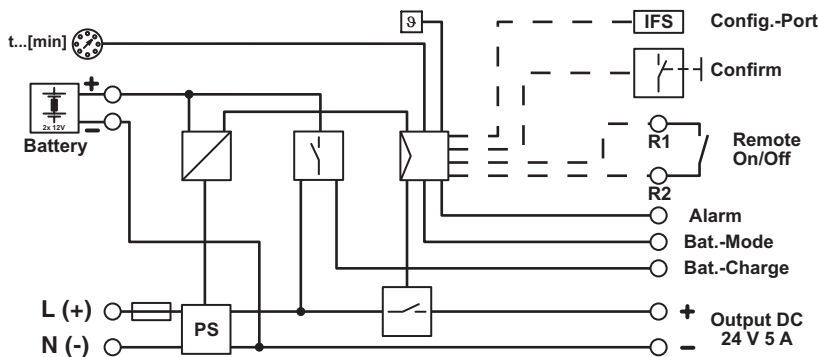

Figure 2 Block diagram for the TRIO-UPS/1AC/24DC/5

6.3 Input

The 100 ... 240 V AC connection is made using the L (+) and N (-) screw connections.

Device installation must be carried out according to the regulations of EN 60950. It must be possible to switch off the device using a suitable disconnecting device outside the power supply.

i For example, primary side line protection could be used.

An internal fuse is provided for device protection. Additional device protection is not required.

i If an internal fuse is blown, this is due to a device fault. In this case, send the device to Phoenix Contact for inspection.

Network type

The device can be connected to single-phase AC networks or to two of the phase conductors of three-phase systems (TN, TT or IT networks according to VDE 0100-300/IEC 60364-3) with nominal voltages of 100 V AC ... 240 V AC.

i For operation using two phase conductors of a three-phase system, an all-pole disconnecting device must be provided.

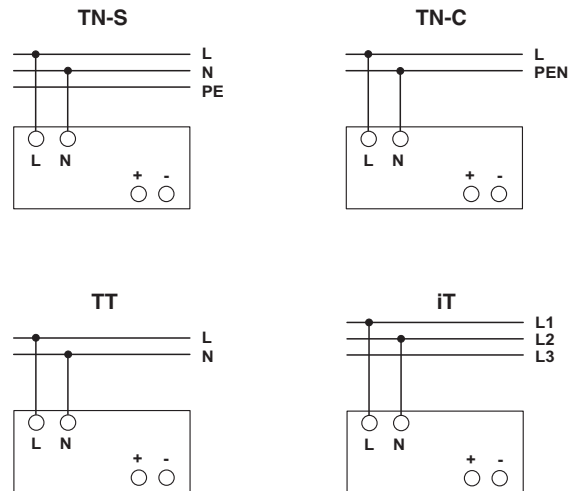

Figure 3 Single-phase network systems

6.4 Output

The 24 V DC connection is made using the "OUT DC 24 V, +, -" screw connections. The output voltage set upon delivery is 24 V DC. The output voltage can be set from 22.5 V DC to 29.5 V DC on the potentiometer.

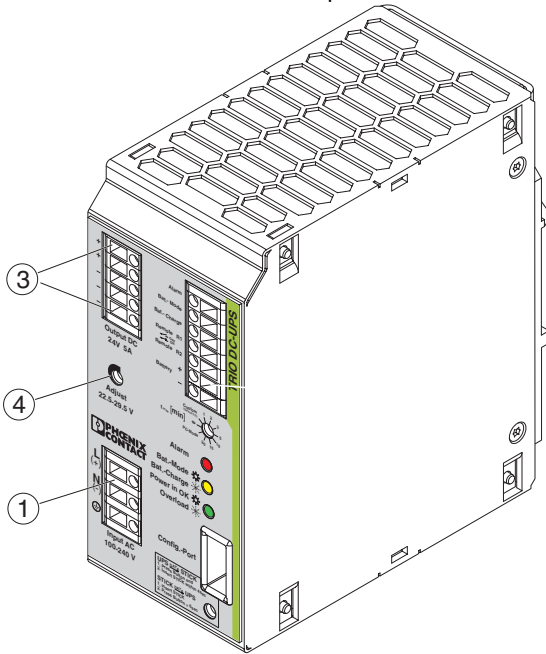

Figure 4 Connection

No.	Description
1	100 ... 240 V AC input
2	24 V DC output, buffered
3	22.5 ... 29.5 V DC potentiometer

6.5 LED indicators

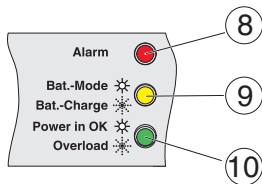

Figure 5 LED indicators

No.	Description
8	Red LED indicator: Alarm
9	Yellow LED indicator: Bat.-Mode/Bat.-Charge
10	Green LED indicator: Power in OK/Overload

The signal outputs are connected via the "Alarm", "Bat.-Mode", and "Bat.-Charge" terminal blocks. There are three LED status indicators and three active switching outputs for function monitoring.

Status	Green	Yellow	Red	Description
1	○	○	○	The UPS is switched off or the UPS is operating in mains mode, battery mode is deactivated (remote), battery management is still active
2	☀	☀	☀	The UPS is starting mains operation, for the LED test all LEDs are switched on and off again once before the current operating state is indicated
3	☀	○	○	The UPS is operating in mains mode, the battery is OK and charged
4	☀	☀	○	The UPS is operating in mains mode, the battery is OK and is charging (charge < 85% of nominal capacity)
5	○	☀	○	The UPS is operating in battery mode, the battery voltage U_{BAT} is > 20.4 V
6	○	☀	☀	The UPS is operating in battery mode, the battery is almost flat (battery voltage U_{BAT} is < 20.4 V)
7	○	○	☀	UPS protection against total discharge has terminated battery mode (battery voltage U_{BAT} = 19.2 V) and continues indication for a maximum of 10 hours
8	☀	○	☀	The UPS is operating in mains mode, the battery is faulty
9	☀	○	○	The UPS has been overloaded in mains mode, the battery is OK and charged
10	☀	○	☀	The UPS has been overloaded in mains mode, the battery is faulty

Key

LED OFF	○
LED ON	☀
LED flashing	☀

7 Installation

A minimum spacing between other devices does not have to be observed in order to ensure correct device function.

7.1 Narrow mounting position

The power supply unit can be snapped onto all DIN rails according to EN 60715 and must be mounted horizontally (connection terminal blocks facing upwards and downwards).

Mounting

Position the module with the DIN rail guideway on the top edge of the DIN rail and then snap it downwards.

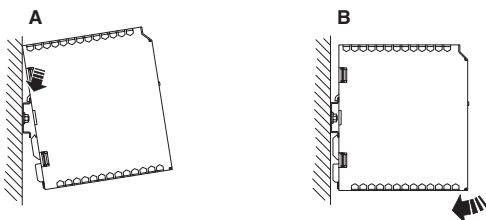

Figure 6 Mounting the TRIO-UPS/1AC/24DC/5

Removal

Release the snap-on catch using a screwdriver and then detach the module from the bottom edge of the DIN rail.

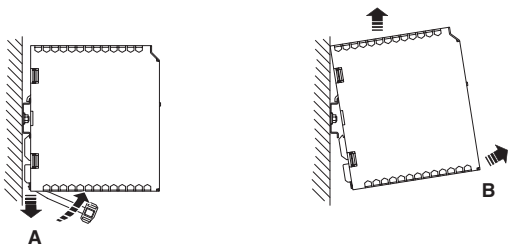

Figure 7 Removing the TRIO-UPS/1AC/24DC/5

7.2 Flat mounting position

A flat mounting position can be achieved by mounting the module onto the DIN rail at a 90° angle. Mount the DIN rail adapter (UTA 107) as shown in the figure. The screws that were previously used to secure the UTA must be used: Torx T10 (0.8 Nm ... 0.9 Nm tightening torque).

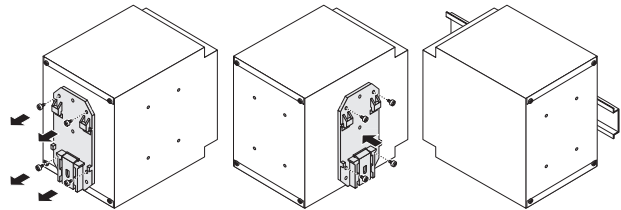

Figure 8 Modification for flat mounting position

8 Rechargeable battery module

The rechargeable battery module is connected to the power supply unit via the "Battery +" and "Battery -" terminal blocks ②.



NOTE: Risk of short circuit

The fuse for the rechargeable battery module must be removed when installing or replacing the module.



The batteries are sealed, maintenance-free lead AGM batteries, which are intended for operating temperatures of 0°C ... 40°C.

They have a service life of six to nine years at an ambient temperature of 20°C.

In order to ensure immediate availability, all batteries are supplied fully charged. Startup should be carried out at the latest after nine months at 20°C ... 30°C, or after six months at 30°C ... 40°C.

The following rechargeable battery modules are recommended:

	Rechargeable battery module	Fuse	Recommended charging current
①	MINI-BAT/24DC/1.3Ah	15 A	0.8 A ²
②	QUINT-BAT/24DC/3.4Ah ¹	25 A	1.0 A ²
③	QUINT-BAT/24DC/7.2Ah ¹	2 x 25 A	1.5 A ²
④	QUINT-BAT/24DC/12Ah ¹	2 x 25 A	1.5 A ²

¹ Connection via plug connector, 14 mm

² Can be adjusted via UPS-CONF software

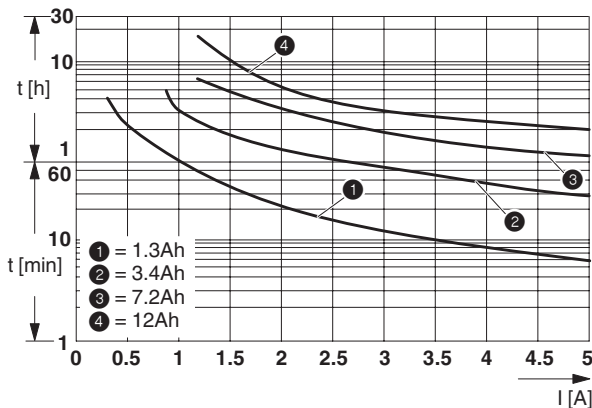

Figure 9 Characteristic curves for the rechargeable battery modules

Battery mode can be exited after a predefined time has elapsed or by means of external shutdown. If the device is to be shut down after a specific time has elapsed, the time can be set via the selector switch ⑫ on the front of the device. When the supply voltage is reapplied, the device can switch to battery mode again.

9 Method of operation

9.1 Output voltage

In mains operation (AC input voltage present) the output voltage of the TRIO-UPS corresponds to the setting at the potentiometer ④. In the event of supply voltage failure, battery mode is activated without interruption. The output voltage is now directly dependent on the battery voltage and is $U_{BAT} - 0.5 \text{ V}$.

9.2 Remote shutdown

If the connected load cannot be supplied from the power storage device in the event that the AC voltage fails, the UPS can be disabled via R1/R2. This shutdown can be performed during mains operation or while battery mode is active.

UPS active, remote shutdown deactivated, default upon delivery:

- Terminal points "R1" and "R2" are short circuited (with plug-in bridges by default upon delivery) OR 24 V DC is present at terminal point "R2".
- If the supply voltage fails, the TRIO-UPS switches to battery mode. UPS not active, remote shutdown activated:
- Terminal points "R1" and "R2" are not short circuited AND 0 V DC is present at terminal point "R2".
- All LEDs are OFF.
- If the supply voltage fails, the TRIO-UPS does not switch to battery mode, the device shuts down.
- The connected loads are supplied and the rechargeable battery module is charged as long as the supply voltage is present.

9.3 Buffer time setting

The time after which battery mode is exited is set via the ⑫ selector switch on the front of the device:

- 0.5 to 20 minutes
- Parameterizable time via software ("CUSTOM" switch position, default: 0.5 minutes)
- Unlimited (buffering with the total stored energy)
- PC mode (see Section 9.4 "PC mode")

9.4 PC mode

In "PC mode", the UPS function follows a chronological sequence that can be parameterized via the software and individually optimized for the relevant IPC solution.

Requirements: IFS-USB-PROG-ADAPTER data cable (Order No. 2811271) and UPS-CONF software (Order No. 2320403).

To set the parameters, an Interface interface (IFS) is used for data exchange between the TRIO-UPS and a suitable user interface on the IPC. The user is supported by help texts and graphics for the individual parameters.

As an option, parameterization can be carried out using an IFS-CONFSTICK. Here, a parameter record is transferred from the TRIO-UPS to the IFS-CONFSTICK. This parameter record can then be written to any other TRIO-UPS.

In "PC mode", the UPS function follows a parameterizable chronological sequence of delay time, IPC shutdown, and IPC idle time.

Delay time:

If the mains voltage is not applied again within the first 60 seconds of battery mode, for example, "Bat.-Mode" is indicated in order to shut down an IPC with a delay.

IPC shutdown:

Shutdown is performed via a data cable to the IPC. The IPC must be connected to the UPS via a USB data cable.

The IPC is supplied by the TRIO-UPS for a parameterizable period of time, e.g., 2 minutes.

9.5 PC idle time

Once the "PC shutdown" time has elapsed, the output voltage is switched off, e.g., for 30 seconds (also when the mains voltage is applied again).

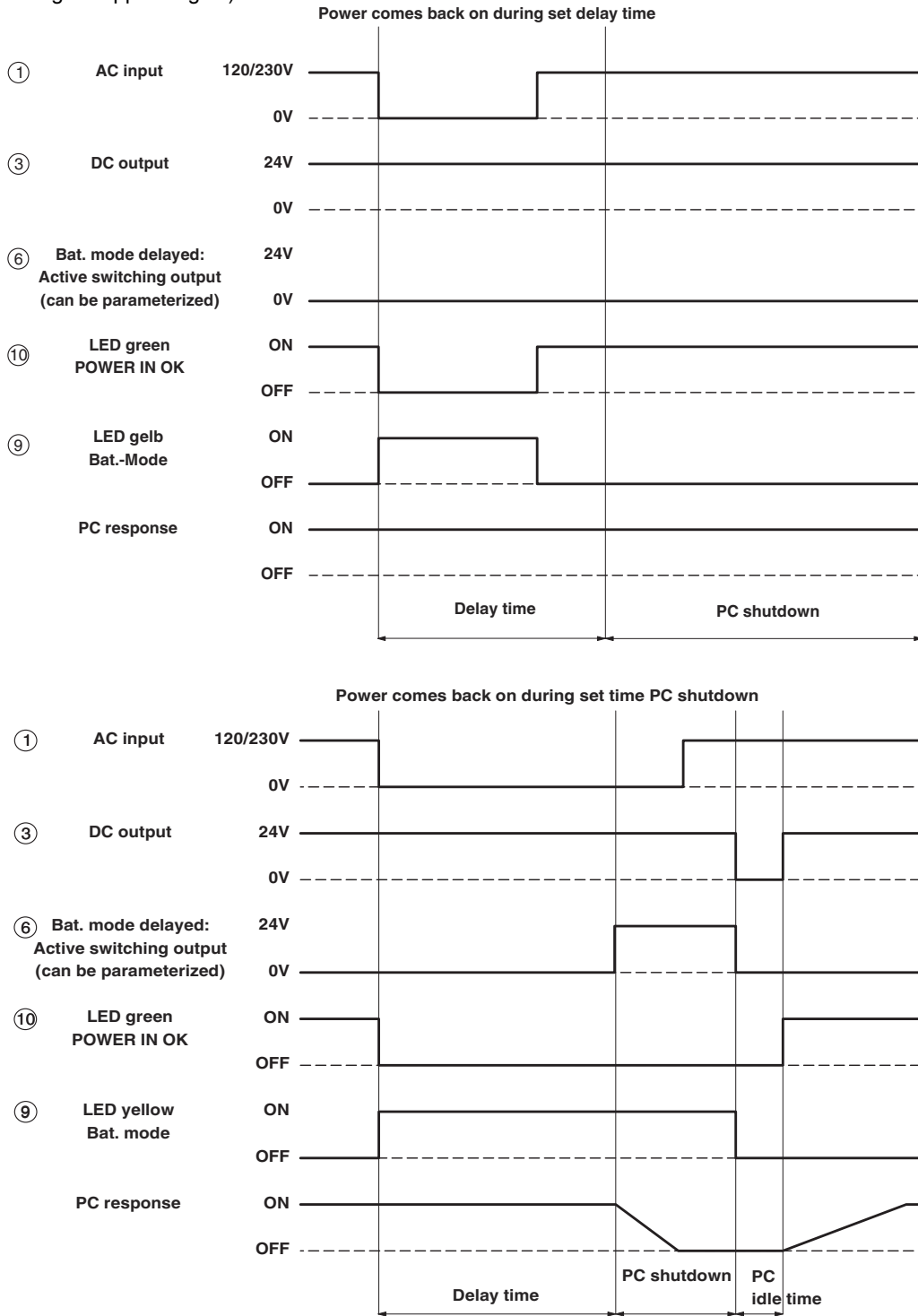

Figure 10 Time diagrams

9.6 Battery management

Battery management of the TRIO-UPS is divided into two checks that are performed cyclically during normal operation.

Battery presence check

The battery presence check is used to detect a correctly installed battery. If this is not the case, the check is failed and the green ⑩ and red ⑧ LED indicators are controlled statically.

Battery quality check

The battery quality check is a lifecycle test. It enables conclusions to be drawn, e.g., regarding the maximum lifecycle of the battery if the maximum charging time has been exceeded. In this case, the green ⑩ and red ⑧ LED indicators are controlled statically.

10 Interfaces

10.1 Config.-Port

The TRIO-UPS is connected to the USB connection on the service PC via the "Config.-Port" using the IFS-USB-PROG-ADAPTER data cable.

10.2 IFS-USB-PROG-ADAPTER

The programming adapter (Order No. 2811271) represents the interface between the service PC and the TRIO-UPS and is required in order to parameterize the TRIO-UPS.

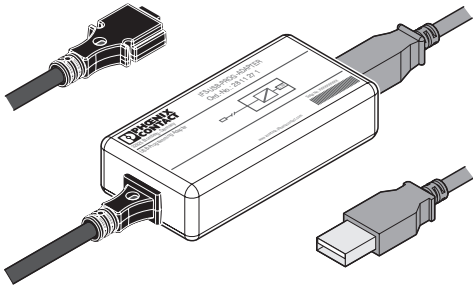

Figure 11 Programming adapter

10.3 IFS-CONFSTICK

The IFS-CONFSTICK is a multi-functional memory block for easy storage and back up of configuration and parameter data.

Transferring parameters to the IFS-CONFSTICK

To transfer parameters, proceed as follows:

1. Press and hold down the "Confirm" button.
2. You now have four seconds to carefully insert the IFS-CONFSTICK in the "Config.-Port" on the TRIO-UPS, taking care to observe the connection direction.
3. Parameter transfer is started and indicated by the cyclic control of the three LED indicators. Sequence: Red - Yellow - Green
 - a) Error-free transfer:
Green LED indicator ON
 - b) Transfer error:
Red LED indicator ON

Transferring parameters to the TRIO-UPS

To transfer parameters, proceed as follows:

1. Carefully insert the IFS-CONFSTICK in the "Config.-Port" on the TRIO-UPS, taking care to observe the connection direction.
1. Press and hold down the "Confirm" button for at least six seconds.
2. Parameter transfer is started and indicated by the cyclic control of the three LED indicators. Sequence: Green - Yellow - Red
 - a) Error-free transfer:
Green LED indicator ON
 - b) Transfer error:
Red LED indicator ON

The following can be parameterized:

- Times
- Switching outputs
- Battery management

11 UPS-CONF configuration and management software

The Windows-based UPS-CONF configuration and management software (Order No. 2320403) is used to parameterize the TRIO-UPS.



The UPS-CONF configuration and management software can be downloaded free of charge at www.phoenixcontact.net/download.

Various dialog boxes are available for parameterization. The current operating status of the TRIO-UPS is always displayed at the bottom of the dialog box.



Figure 12 Example, TRIO-UPS status display

A distinction is made between the following states:

Status	Meaning
Operation mode	Preset operating mode at the selector switch ⑫
Power Source	Power source that is currently active
Battery Condition	Current battery charging state
Device Status	Current state of the TRIO-UPS
Connection to UPS	Connection status between service PC and TRIO-UPS



If an alarm is detected or an existing online connection between the IPC and TRIO-UPS is interrupted, the UPS-CONF dialog box is automatically displayed on screen. The status is queried cyclically.