



Chipsmall Limited consists of a professional team with an average of over 10 year of expertise in the distribution of electronic components. Based in Hongkong, we have already established firm and mutual-benefit business relationships with customers from,Europe,America and south Asia,supplying obsolete and hard-to-find components to meet their specific needs.

With the principle of “Quality Parts,Customers Priority,Honest Operation,and Considerate Service”,our business mainly focus on the distribution of electronic components. Line cards we deal with include Microchip,ALPS,ROHM,Xilinx,Pulse,ON,Everlight and Freescale. Main products comprise IC,Modules,Potentiometer,IC Socket,Relay,Connector.Our parts cover such applications as commercial,industrial, and automotives areas.

We are looking forward to setting up business relationship with you and hope to provide you with the best service and solution. Let us make a better world for our industry!



Contact us

Tel: +86-755-8981 8866 Fax: +86-755-8427 6832

Email & Skype: info@chipsmall.com Web: www.chipsmall.com

Address: A1208, Overseas Decoration Building, #122 Zhenhua RD., Futian, Shenzhen, China



Hybrid motor starter - ELR H5-SC- 24DC/500AC-9 - 2900538

Please be informed that the data shown in this PDF Document is generated from our Online Catalog. Please find the complete data in the user's documentation. Our General Terms of Use for Downloads are valid (<http://phoenixcontact.com/download>)



Hybrid motor starter for reversing 3~ AC motors up to 500 V AC and 9 A output current, with 24 V DC control voltage, and screw connection.

Why buy this product

- 22.5 mm wide
- Reduction in wiring
- Space saving
- Long service life
- 3-phase loop bridges
- Low-wear switching



Key Commercial Data

Packing unit	1 STK
GTIN	 4 046356 526104
GTIN	4046356526104

Technical data

Device supply

Rated control circuit supply voltage U_s	24 V DC
Control supply voltage range	19.2 V DC ... 30 V DC
Rated control supply current I_s	40 mA
Type of protection	Surge protection
	Reverse polarity protection

Input data

Input name	Control input right/left
Rated actuating voltage U_c	24 V DC
Triggering voltage range	19.2 V DC ... 30 V DC
Rated actuating current I_c	5 mA (Input type 1)

Hybrid motor starter - ELR H5-SC- 24DC/500AC-9 - 2900538

Technical data

Input data

Switching threshold	9.6 V ("0" signal)
	19.2 V ("1" signal)
Typical turn-off time	< 30 ms
Type of protection	Reverse polarity protection

Output data load output

Output name	AC output
Rated operating voltage U_e	500 V AC
Operating voltage range	42 V AC ... 550 V AC
Rated operating current I_e	9 A (AC-51)
	6.5 A (AC-53a)
Mains frequency	50/60 Hz
Load current range	0 A ... 9 A (see to derating)
Trigger characteristic in acc. with IEC 60947-4-2	-
Leakage current	0 mA
Type of protection	Surge protection

General

Switching frequency	≤ 2 Hz (Load-dependent)
Mounting position	vertical (horizontal DIN rail, motor output below)
Mounting type	DIN rail mounting
Assembly instructions	alignable, for spacing see derating
Operating mode	100% operating factor
Maximum power dissipation	7 W
Minimum power dissipation	0.88 W
Operating voltage display	Green LED
Status display	Yellow LED

Connection data, input side

Connection name	Control circuits
Connection method	Screw connection
Stripping length	8 mm
Screw thread	M3
Conductor cross section solid	0.2 mm ² ... 2.5 mm ²
Conductor cross section flexible	0.2 mm ² ... 2.5 mm ²
Conductor cross section AWG	24 ... 14
Torque	0.5 Nm ... 0.6 Nm

Connection data, output side

Connection name	Load circuit
Connection method	Screw connection
Stripping length	8 mm
Screw thread	M3

Hybrid motor starter - ELR H5-SC- 24DC/500AC-9 - 2900538

Technical data

Connection data, output side

Conductor cross section solid	0.2 mm ² ... 2.5 mm ²
Conductor cross section flexible	0.2 mm ² ... 2.5 mm ²
Conductor cross section AWG	24 ... 14
Torque	0.5 Nm ... 0.6 Nm

Ambient conditions

Ambient temperature (operation)	-25 °C ... 70 °C (observe derating)
Ambient temperature (storage/transport)	-40 °C ... 80 °C
Degree of protection	IP20

Dimensions

Width	22.5 mm
Height	106.6 mm
Depth	113.7 mm

UL data

SCCR	100 kA (500 V AC (fuse: 30 A class CC/30 A class J (high fault)))
	5 kA (500 V AC (fuse: 20 A RK5 (standard fault)))
FLA	6.5 A (500 V AC)
Group installation	20 A (class RK5, SCCR 5kA, #24 - 14 AWG max. solid and stranded)
	30 A (class CC or J, SCCR 100kA, #24 - 14 AWG max, solid and stranded)
Category code	NLDX / NRNT

Insulation characteristics

Rated insulation voltage	500 V
Rated surge voltage	6 kV
Overvoltage category	III
Degree of pollution	2
Designation	Insulation characteristics between the control input and control supply voltage, and auxiliary circuit to the main circuit
Insulation	Safe isolation (IEC 60947-1/EN 50178) at operating voltage ≤ 300 V AC
	Basic isolation (IEC 60947-1) at operating voltage 300 ... 500 V AC
	Safe isolation (EN 50178) at operating voltage 300 ... 500 V AC
Designation	Isolation characteristics between the control input and control supply voltage to auxiliary circuit
Insulation	Safe isolation (IEC 60947-1) in the auxiliary circuit ≤ 300 V AC
	Safe isolation (EN 50178) in the auxiliary circuit ≤ 300 V AC

Standards and Regulations

Designation	Standards/regulations
Standards/regulations	IEC 60947-1
	IEC 60947-4-2
	IEC 61508

Hybrid motor starter - ELR H5-SC- 24DC/500AC-9 - 2900538

Technical data

Standards and Regulations

	ISO 13849
--	-----------

Approvals/conformities

UL certificate	NLDX.E228652
----------------	--------------

Environmental Product Compliance

China RoHS	Environmentally Friendly Use Period = 50
	For details about hazardous substances go to tab "Downloads", Category "Manufacturer's declaration"

Drawings

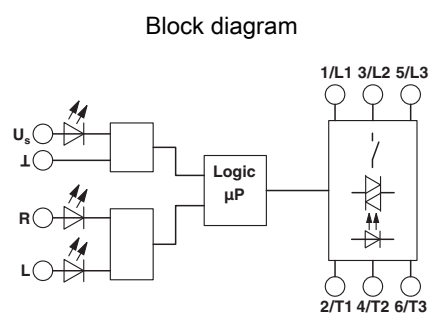
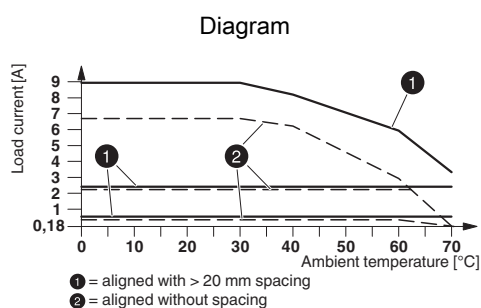

Derating diagram

Approvals

Approvals

Approvals

UL Listed / cUL Listed / IECCE CB Scheme / UL Listed / cUL Listed / EAC / CCC / cULus Listed

Ex Approvals







Approval details

UL Listed		http://database.ul.com/cgi-bin/XYV/template/LISEXT/1FRAME/index.htm	FILE E 228652
-----------	--	---	---------------

cUL Listed		http://database.ul.com/cgi-bin/XYV/template/LISEXT/1FRAME/index.htm	FILE E 228652
------------	--	---	---------------

Hybrid motor starter - ELR H5-SC- 24DC/500AC-9 - 2900538

Approvals

IECEE CB Scheme		http://www.iecee.org/	DE1-55728
UL Listed		http://database.ul.com/cgi-bin/XYV/template/LISEXT/1FRAME/index.htm	FILE E 323771
cUL Listed		http://database.ul.com/cgi-bin/XYV/template/LISEXT/1FRAME/index.htm	FILE E 323771
EAC			RU C- DE.A*30.B.01082
CCC			2016010304871315
cULus Listed			

Phoenix Contact 2018 © - all rights reserved
<http://www.phoenixcontact.com>

PHOENIX CONTACT GmbH & Co. KG
Flachsmarktstr. 8
32825 Blomberg
Germany
Tel. +49 5235 300
Fax +49 5235 3 41200
<http://www.phoenixcontact.com>