



Chipsmall Limited consists of a professional team with an average of over 10 year of expertise in the distribution of electronic components. Based in Hongkong, we have already established firm and mutual-benefit business relationships with customers from,Europe,America and south Asia,supplying obsolete and hard-to-find components to meet their specific needs.

With the principle of "Quality Parts,Customers Priority,Honest Operation,and Considerate Service",our business mainly focus on the distribution of electronic components. Line cards we deal with include Microchip,ALPS,ROHM,Xilinx,Pulse,ON,Everlight and Freescale. Main products comprise IC,Modules,Potentiometer,IC Socket,Relay,Connector.Our parts cover such applications as commercial,industrial, and automotives areas.

We are looking forward to setting up business relationship with you and hope to provide you with the best service and solution. Let us make a better world for our industry!



Contact us

Tel: +86-755-8981 8866 Fax: +86-755-8427 6832

Email & Skype: info@chipsmall.com Web: www.chipsmall.com

Address: A1208, Overseas Decoration Building, #122 Zhenhua RD., Futian, Shenzhen, China



D-SUB bus connector - SUBCON-PLUS-CAN/AX/M12 - 2902326

Please be informed that the data shown in this PDF Document is generated from our Online Catalog. Please find the complete data in the user's documentation. Our General Terms of Use for Downloads are valid (<http://phoenixcontact.com/download>)



D-SUB plug, 9-pos., socket, assignment: 2, 3, 5, 6, 7, 9; two M12 cable glands (A-coded) under 180° (axial). Bus system: CAN, CANopen®. Termination resistor via separate M12 terminator.

Why buy this product

- Assembly under field conditions
- Quick connection thanks to M12-SPEEDCON fast locking system
- Through-contacted shielding from M12 to D-SUB

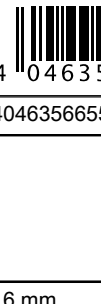

Key Commercial Data

Packing unit	1 STK
GTIN	 4 046356 655019
GTIN	4046356655019

Technical data

Dimensions

Width	16 mm
Height	75 mm
Length	38 mm

Ambient conditions

Ambient temperature (operation)	-30 °C ... 80 °C
Ambient temperature (storage/transport)	-40 °C ... 85 °C
Ambient temperature (assembly)	-20 °C ... 80 °C
Permissible humidity (operation)	10 % ... 75 % (At +25°C, non-condensing)
Altitude	5000 m (For restrictions see manufacturer's declaration)
Degree of protection	IP40

General

Bus system	CAN, CANopen, SafetyBus-P
------------	---------------------------

D-SUB bus connector - SUBCON-PLUS-CAN/AX/M12 - 2902326

Technical data

General

Signal	CAN
	CANopen®
SUBCON fixing screws	4-40 UNC
Tightening torque	0.4 Nm
Housing material	Polyamide
Pin assignment	2, 3, 5, 7, 9
MTTF	6706 Years (SN 29500 standard, temperature 25 °C, operating cycle 21 % (5 days a week, 8 hours a day))
	1817 Years (SN 29500 standard, temperature 40 °C, operating cycle 34.25 % (5 days a week, 12 hours a day))
	155 Years (SN 29500 standard, temperature 40 °C, operating cycle 100 % (7 days a week, 24 hours a day))

Connection data

Connection	D-SUB connection
Number of positions	9
Connection method	D-SUB socket
Termination resistor	separately via M12 termination resistor
Connection	M12 plug
Number of positions	5
Connection method	M12 connector, A-coded
Torque	0.4 Nm
Connection	M12 socket
Number of positions	5
Connection method	M12 connector, A-coded
Torque	0.4 Nm

Standards and Regulations

Noxious gas test	ISA-S71.04-1985 G3 Harsh Group A
------------------	----------------------------------

Environmental Product Compliance

China RoHS	Environmentally friendly use period: unlimited = EFUP-e
	No hazardous substances above threshold values

Drawings

D-SUB bus connector - SUBCON-PLUS-CAN/AX/M12 - 2902326

Block diagram

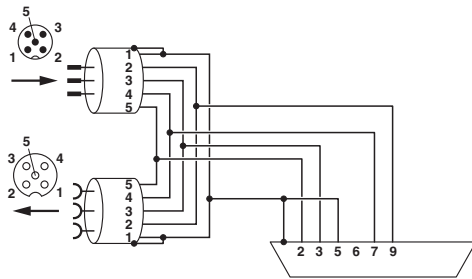

Dimensional drawing

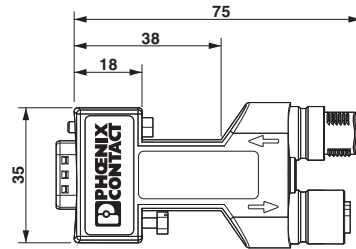

SUBCON-PLUS...AX...M12 dimensional drawing, axial (180°) version

SUBCON-PLUS-CAN/...M12 function block diagram

Schematic diagram

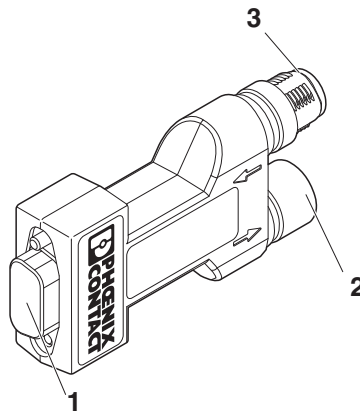

Function elements

- 1 = D-SUB 9
- 2 = Outgoing M12 connection
- 3 = Incoming M12 connection
- 4 = D-SUB PG connection (depending on the version)

Approvals

Approvals

Approvals

UL Recognized / cUL Recognized / cULus Recognized

Ex Approvals

Approval details

D-SUB bus connector - SUBCON-PLUS-CAN/AX/M12 - 2902326

Approvals

UL Recognized		http://database.ul.com/cgi-bin/XYV/template/LISEXT/1FRAME/index.htm	FILE E 238705
---------------	---	---	---------------

cUL Recognized		http://database.ul.com/cgi-bin/XYV/template/LISEXT/1FRAME/index.htm	FILE E 238705
----------------	---	---	---------------

cULus Recognized		http://database.ul.com/cgi-bin/XYV/template/LISEXT/1FRAME/index.htm	
------------------	---	---	--

Phoenix Contact 2018 © - all rights reserved
<http://www.phoenixcontact.com>

PHOENIX CONTACT GmbH & Co. KG
Flachsmarktstr. 8
32825 Blomberg
Germany
Tel. +49 5235 300
Fax +49 5235 3 41200
<http://www.phoenixcontact.com>