



Chipsmall Limited consists of a professional team with an average of over 10 year of expertise in the distribution of electronic components. Based in Hongkong, we have already established firm and mutual-benefit business relationships with customers from,Europe,America and south Asia,supplying obsolete and hard-to-find components to meet their specific needs.

With the principle of “Quality Parts,Customers Priority,Honest Operation,and Considerate Service”,our business mainly focus on the distribution of electronic components. Line cards we deal with include Microchip,ALPS,ROHM,Xilinx,Pulse,ON,Everlight and Freescale. Main products comprise IC,Modules,Potentiometer,IC Socket,Relay,Connector.Our parts cover such applications as commercial,industrial, and automotives areas.

We are looking forward to setting up business relationship with you and hope to provide you with the best service and solution. Let us make a better world for our industry!



Contact us

Tel: +86-755-8981 8866 Fax: +86-755-8427 6832

Email & Skype: info@chipsmall.com Web: www.chipsmall.com

Address: A1208, Overseas Decoration Building, #122 Zhenhua RD., Futian, Shenzhen, China



Electronic device circuit breaker - HMC 11 120AC 1A C1D2 - 2907191

Please be informed that the data shown in this PDF Document is generated from our Online Catalog. Please find the complete data in the user's documentation. Our General Terms of Use for Downloads are valid (<http://phoenixcontact.com/download>)



HMC series of supplemental circuit protector modules, 1 A rating

Why buy this product

- Optional T-bus for reduced wiring
- UL recognized for hazardous locations Class I, Division 2, Groups A, B, C, and D
- Dual-rated for 50 V DC and 120 V AC
- Hydraulic-magnetic technology provides extended temperature stability

Key Commercial Data

Packing unit	1 STK
GTIN	 4 055626 342344
GTIN	4055626342344
Weight per Piece (excluding packing)	150.000 g
Country of origin	United States

Technical data

Note

Trade restriction	The products are offered exclusively for export outside the EU and the European Economic Area.
-------------------	--

Dimensions

Height	93.6 mm
Width	22.6 mm
Depth	109.2 mm

Ambient conditions

Ambient temperature (operation)	-40 °C ... 65 °C
Ambient temperature (storage/transport)	-40 °C ... 65 °C

General

Electronic device circuit breaker - HMC 11 120AC 1A C1D2 - 2907191

Technical data

General

Flammability rating according to UL 94	V0
Mounting type	DIN rail: 35 mm
Color	gray
Number of positions	4

Electrical data

Rated voltage	120 V AC (50/60 Hz)
	50 V DC
Nominal current I_N	1 A
Rated short-circuit switching capacity I_{cn}	1 kA ()

Standards and Regulations

Standards/specifications	UL 1077
--------------------------	---------

Drawings

Diagram

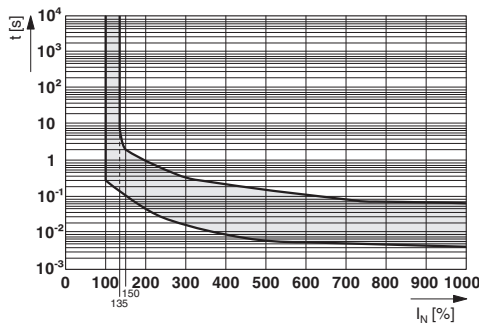

Dimensional drawing

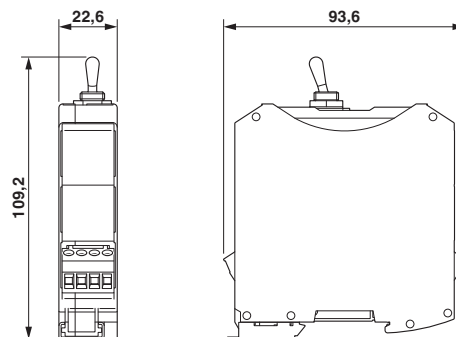

Classifications

eCl@ss

eCl@ss 5.0	27141116
eCl@ss 5.1	27141116
eCl@ss 8.0	27141116
eCl@ss 9.0	27141116

ETIM

ETIM 5.0	EC000899
----------	----------

UNSPSC

UNSPSC 13.2	39121410
-------------	----------

Electronic device circuit breaker - HMC 11 120AC 1A C1D2 - 2907191

Approvals

Approvals

Approvals

UL Recognized / cUL Recognized / cULus Recognized

Ex Approvals

UL Recognized / cUL Recognized / cULus Recognized

Approval details

UL Recognized		http://database.ul.com/cgi-bin/XYV/template/LISEXT/1FRAME/index.htm	FILE E 140459
---------------	---	---	---------------

cUL Recognized		http://database.ul.com/cgi-bin/XYV/template/LISEXT/1FRAME/index.htm	FILE E 140459
----------------	---	---	---------------

cULus Recognized		http://database.ul.com/cgi-bin/XYV/template/LISEXT/1FRAME/index.htm	
------------------	---	---	--

Accessories

Accessories

DIN rail

DIN rail perforated - NS 35/ 7,5 PERF 2000MM - 0801733



DIN rail, material: steel galvanized and passivated with a thick layer, perforated, height 7.5 mm, width 35 mm, length: 2000 mm

Electronic device circuit breaker - HMC 11 120AC 1A C1D2 - 2907191

Accessories

DIN rail, unperforated - NS 35/ 7,5 CU UNPERF 2000MM - 0801762



DIN rail, material: Copper, unperforated, height 7.5 mm, width 35 mm, length: 2 m

DIN rail, unperforated - NS 35/15 UNPERF 2000MM - 1201714

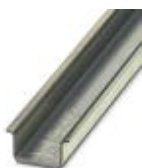

DIN rail, material: Steel, unperforated, height 15 mm, width 35 mm, length: 2 m

DIN rail, unperforated - NS 35/15 CU UNPERF 2000MM - 1201895



DIN rail, material: Copper, unperforated, 1.5 mm thick, height 15 mm, width 35 mm, length: 2 m

DIN rail, unperforated - NS 35/15-2,3 UNPERF 2000MM - 1201798



DIN rail, unperforated, Width: 35 mm, Height: 15 mm, Length: 2000 mm, Color: silver

DIN rail, unperforated - NS 35/15 AL UNPERF 2000MM - 1201756



DIN rail, deep drawn, high profile, unperforated, 1.5 mm thick, material: aluminum, height 15 mm, width 35 mm, length 2000 mm

Electronic device circuit breaker - HMC 11 120AC 1A C1D2 - 2907191

Accessories

DIN rail perforated - NS 35/15 PERF 2000MM - 1201730



DIN rail, material: steel galvanized and passivated with a thick layer, perforated, height 15 mm, width 35 mm, length: 2000 mm

End block

End clamp - CLIPFIX 35-5 - 3022276



Quick mounting end clamp for NS 35/7,5 DIN rail or NS 35/15 DIN rail, with marking option, with parking option for FBS...5, FBS...6, KSS 5, KSS 6, width: 5.15 mm, color: gray

End clamp - E/UK 1 - 1201413



End clamps, for supporting the ends of double-level and three-level terminal blocks, width: 10 mm, color: gray