



Chipsmall Limited consists of a professional team with an average of over 10 year of expertise in the distribution of electronic components. Based in Hongkong, we have already established firm and mutual-benefit business relationships with customers from,Europe,America and south Asia,supplying obsolete and hard-to-find components to meet their specific needs.

With the principle of "Quality Parts,Customers Priority,Honest Operation,and Considerate Service",our business mainly focus on the distribution of electronic components. Line cards we deal with include Microchip,ALPS,ROHM,Xilinx,Pulse,ON,Everlight and Freescale. Main products comprise IC,Modules,Potentiometer,IC Socket,Relay,Connector.Our parts cover such applications as commercial,industrial, and automotives areas.

We are looking forward to setting up business relationship with you and hope to provide you with the best service and solution. Let us make a better world for our industry!



Contact us

Tel: +86-755-8981 8866 Fax: +86-755-8427 6832

Email & Skype: info@chipsmall.com Web: www.chipsmall.com

Address: A1208, Overseas Decoration Building, #122 Zhenhua RD., Futian, Shenzhen, China



QUINT4-PS/1AC/24DC/2.5/PT

Power supply unit

Data sheet
108315_en_00

© PHOENIX CONTACT 2017-12-13



1 Description

QUINT POWER power supplies are exceptionally small yet offer superior system availability in the sub 100 W power range.

Powerful

- Static boost of up to 125% (P_N) for a sustained period
- Dynamic boost of up to 200% (P_N) for 5 s

Space-saving

- Slim design
- Slim design for 120 mm control boxes

Preventive

- Function monitoring through adjustable signaling of power thresholds or output voltage

Flexible connection technology

- Tried-and-tested screw connection
- Fast Push-in connection

Durable

- Efficiency up to 92%
- Low power dissipation

Technical data (short form)

Input voltage range	100 V AC ... 240 V AC -15 % ... +10 %
Mains buffering	> 54 ms (120 V AC) > 54 ms (230 V AC)
Nominal output voltage (U_N)	24 V DC
Setting range of the output voltage (U_{Set})	24 V DC ... 28 V DC
Nominal output current (I_N)	2.5 A
Static Boost ($I_{Stat.Boost}$)	3.125 A (permanently up to 40°C)
Dynamic Boost ($I_{Dyn.Boost}$)	5 A (Available up to 60°C for 5 s)
Output power (P_N)	60 W
Output power ($P_{Stat. Boost}$)	75 W
Output power ($P_{Dyn. Boost}$)	120 W
Efficiency	typ. 91.9 % (120 V AC) typ. 92.6 % (230 V AC)
Residual ripple	< 40 mV _{pp}
MTBF (IEC 61709, SN 29500)	> 734000 h (40 °C)
Ambient temperature (operation)	-25 °C ... 70 °C -40°C (startup type tested) > 60 °C Derating: 2.5 %/K
Dimensions W/H/D	32 mm / 106 mm / 90 mm
Weight	0.244 kg



All technical specifications are nominal and refer to a room temperature of 25 °C and 70% relative humidity at 100 m above sea level.

2	Table of contents	
1	Description	1
2	Table of contents	2
3	Ordering data	3
4	Technical data	4
5	Safety and installation notes	12
6	High-voltage test (HIPOT)	13
6.1	High-voltage dielectric test (dielectric strength test)	13
6.2	High-voltage dielectric test during the manufacturing process	13
6.3	High-voltage dielectric test performed by the customer	13
7	Structure of the power supply	15
7.1	Function elements	15
7.2	Device dimensions	15
7.3	Keep-out areas	16
7.4	Block diagram	17
8	Mounting/removing the power supply	18
8.1	Mounting the power supply unit	18
8.2	Removing the power supply unit	18
8.3	Fix connection wiring to the power supply	19
9	Device connection terminal blocks	20
9.1	Input	20
9.2	Protection of the primary side	20
9.3	Output	21
9.4	Protection of the secondary side	21
10	Output characteristic curves	22
11	Boost currents	23
11.1	Static Boost	23
11.2	Dynamic Boost	23
12	Signaling	24
12.1	Rotary selector switch in position DC OK	24
12.2	Rotary selector switch in position >50 %, >75 % or boost >100 %	24
12.3	Location and function of the signaling elements	24
12.4	Active signal outputs, digital	25
13	Operating modes	26
13.1	Series operation	26
13.2	Parallel operation	26
14	Derating	28
14.1	Ambient temperature	28
14.2	Installation height	28

3 Ordering data

Description	Type	Order No.	Pcs./Pkt.
Primary-switched QUINT POWER power supply with Push-in connection for DIN rail mounting, input: single-phase, output: 24 V DC / 2.5 A	QUINT4-PS/1AC/24DC/2.5/PT	2909576	1
Accessories	Type	Order No.	Pcs./Pkt.
Pluggable device protection, according to type 3/class III, for 1-phase power supply networks with separate N and PE (3-conductor system: L1, N, PE), with integrated surge-proof fuse and remote indication contact. Also suitable for DC applications.	PLT-SEC-T3-230-FM	2905229	1
Pluggable device protection, according to type 3/class III, for 1-phase power supply networks with separate N and PE (3-conductor system: L1, N, PE), with integrated surge-proof fuse and remote indication contact. Also suitable for DC applications.	PLT-SEC-T3-24-FM	2905223	1
Screwdriver, flat bladed, size: 0.4 x 2.0 x 60 mm, 2-component grip, with non-slip grip	SF-SL 0,4X2,0-60	1212546	10
Multi-channel electronic device circuit breaker for protecting four loads at 24 V DC in the event of overload and short circuit. With electronic locking of the set nominal currents. For installation on DIN rails.	CBMC E4 24DC/1-10A NO	2906032	1
Multi-channel electronic device circuit breaker for protecting four loads at 24 V DC in the event of overload and short circuit. With electronic locking of the set nominal currents. For installation on DIN rails.	CBMC E4 24DC/1-4A NO	2906031	1
Multi-channel electronic device circuit breaker that can be preconfigured, for protecting four loads at 24 V DC in the event of overload and short circuit. With electronic locking of the set nominal currents. For installation on DIN rails.	CBMC E4 24DC/1-4A NO-C	2908713	1



The range of accessories is being continuously extended. The current range of accessories can be found in the download area for the product.

4 Technical data

Input data



Unless otherwise stated, all data applies for 25°C ambient temperature, 230 V AC input voltage, and nominal output current (I_N).

Input voltage range	100 V AC ... 240 V AC -15 % ... +10 % 110 V DC ... 250 V DC -20 % ... +40 %
Electric strength, max.	300 V AC 30 s
Frequency range (f_N)	50 Hz ... 60 Hz -10 % ... +10 %
Current consumption (for nominal values) typ.	0.85 A (100 V AC) 0.7 A (120 V AC) 0.39 A (230 V AC) 0.37 A (240 V AC) 0.75 A (110 V DC) 0.33 A (250 V DC)



The specified values for current consumption apply for operation in the static boost ($P_N \times 125\%$).

Discharge current to PE typical	< 0.25 mA (264 V AC, 60 Hz) 0.22 mA (264 V AC, 60 Hz)
Mains buffering	> 54 ms (120 V AC) > 54 ms (230 V AC)
Typical response time	500 ms
Protective circuit	Transient surge protection Varistor
Switch-on current surge limitation typical after 1 ms	4.3 A
Inrush surge current I^2t	< 0.1 A ² s
Input fuse slow-blow, internal	3.15 A



During the first few microseconds, the current flow into the filter capacitors is excluded.



The SCCR value (short-circuit current rating) of the power supply unit corresponds to the SCCR value of the backup fuse (see input protection table).

Input protection , AC (to be connected externally upstream)

Input current I_{IN} Input protection	Circuit breaker					Neozed fuse or equivalent gG	Power switch $\leq 13 \times I_{IN}$ (maximum magnetic tripping)
	A	B	C	D	K		
6 A	-	✓	✓	-	-	-	-
8 A	-	✓	✓	-	-	-	-
10 A	-	✓	✓	-	-	-	-
13 A	-	✓	✓	-	-	-	-
16 A	-	✓	✓	-	-	-	-

Electric strength of the insulation

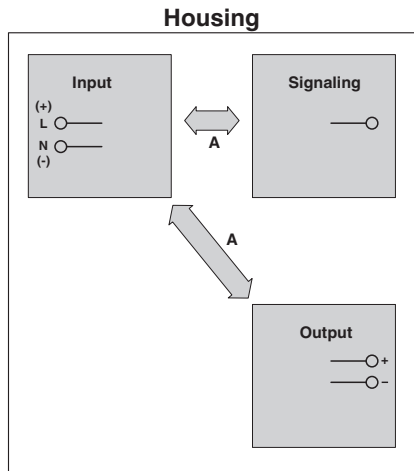

	A
Type test (IEC/EN 60950-1)	4 kV AC
Production test	3 kV AC
Field test	2 kV AC

POWER factor

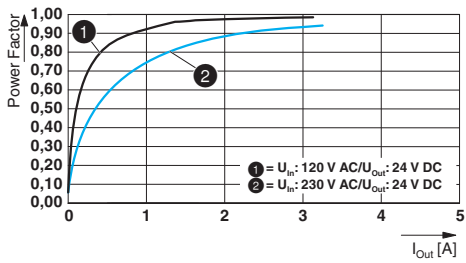

Crest factor	120 V AC	230 V AC
		typ. 1,69

Input current vs. output current

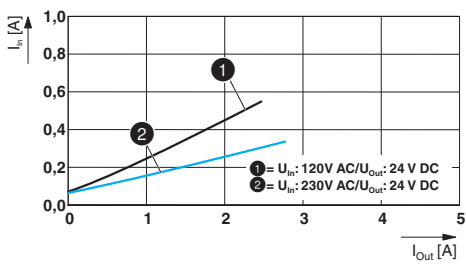

Input connection data

Connection method	Push-in technology
Conductor cross section, solid	0.2 mm ² ... 2.5 mm ²
Conductor cross section, flexible	0.2 mm ² ... 2.5 mm ²
Stranded conductor cross section with ferrule	0.25 mm ² ... 2.5 mm ²
Conductor cross section AWG	24 ... 14
Stripping length	10 mm
Tightening torque	0.5 Nm ... 0.6 Nm

Output data

Nominal output voltage (U _N)	24 V DC
Setting range of the output voltage (U _{Set}) (constant capacity)	24 V DC ... 28 V DC
Nominal output current (I _N)	2.5 A
Static Boost (I _{Stat.Boost})	3.125 A (permanently up to 40°C)
Dynamic Boost (I _{Dyn.Boost})	5 A (Available up to 60°C for 5 s)
Control deviation Static load change 10 % ... 90 %	< 0.5 %
Control deviation Dynamic load change 10 % ... 90 %, (10 Hz)	< 2 %
Control deviation change in input voltage ±10 %	< 0.1 %
Short-circuit-proof	yes
No-load proof	yes
Residual ripple (with nominal values)	< 40 mV _{PP}
Connection in parallel	Yes, for redundancy and increased capacity
Connection in series	yes
Feedback resistance	≤ 35 V DC
Circuit breaker against surge voltage at output by invasive foreign matter	≤ 32 V DC
Rise time typical	50 ms (U _{Out} = 10 % ... 90 %)

Output connection data

Connection method	Push-in technology
Conductor cross section, solid	0.2 mm ² ... 2.5 mm ²
Conductor cross section, flexible	0.2 mm ² ... 2.5 mm ²
Stranded conductor cross section with ferrule	0.25 mm ² ... 2.5 mm ²
Conductor cross section AWG	24 ... 14
Stripping length	10 mm
Tightening torque	0.5 Nm ... 0.6 Nm

LED signaling

P _{Out} > P _{Thr}	LED lights up yellow, output power > P _{Thr} , depending on the rotary selector switch setting
U _{Out} > 0.9 x U _{Set}	LED lights up green
U _{Out} < 0.9 x U _{Set}	LED flashes green

Signal contact (adjustable)	
Digital	0 / 24 V DC , 30 mA
Default	24 V DC , 30 mA (24 V DC for $U_{Out} > 0.9 \times U_{Set}$)

Signal connection data	
Connection method	Push-in technology
Conductor cross section, solid	0.2 mm ² ... 2.5 mm ²
Conductor cross section, flexible	0.2 mm ² ... 2.5 mm ²
Stranded conductor cross section with ferrule	0.25 mm ² ... 2.5 mm ²
Conductor cross section AWG	24 ... 14
Stripping length	10 mm
Tightening moment	0.5 Nm ... 0.6 Nm

Reliability	230 V AC
MTBF (IEC 61709, SN 29500)	> 1347000 h (25 °C) > 734000 h (40 °C) > 295000 h (60 °C)

Life expectancy (electrolytic capacitors) Output current (I_{Out})	120 V AC	230 V AC
2.5 A	> 148000 h (40 °C)	> 153000 h (40 °C)
2.5 A	> 419000 h (25 °C)	> 432000 h (25 °C)



The expected service life is based on the capacitors used. If the capacitor specification is observed, the specified data will be ensured until the end of the stated service life. For runtimes beyond this time, error-free operation may be reduced. The specified service life of more than 15 years is simply a comparative value.

Switching frequency	Min.	Max.
PFC stage	30 kHz	150 kHz
Auxiliary converter stage	4 kHz	70 kHz
Main converter stage	70 kHz	150 kHz

General data	
Degree of protection	IP20
Protection class	II
Inflammability class in acc. with UL 94 (housing / terminal blocks)	V0
Type of housing	Polycarbonate
Hood version	Polycarbonate
Dimensions W / H / D (state of delivery)	32 mm / 106 mm / 90 mm
Weight	0.244 kg

Power dissipation	120 V AC	230 V AC
Maximum power dissipation in no-load condition	< 1 W	< 1 W
Power loss nominal load max.	< 5 W	< 5 W

Efficiency

120 V AC

230 V AC

typ. 91.9 %

typ. 92.6 %

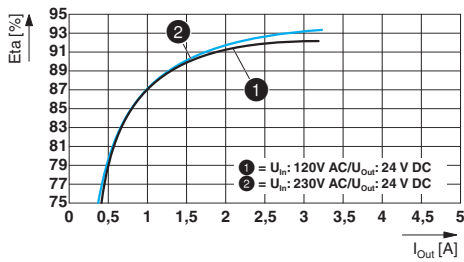

Ambient conditions

Ambient temperature (operation) -25 °C ... 70 °C (> 60 °C Derating: 2.5 %/K)



The ambient temperature (operation) refers to IEC 61010 surrounding air temperature.

Ambient temperature (start-up type tested)	-40 °C
Ambient temperature (storage/transport)	-40 °C ... 85 °C
Max. permissible relative humidity (operation)	≤ 95 % (at 25 °C, non-condensing)
Installation height	≤ 5000 m (> 2000 m, observe derating)
Vibration (operation)	< 15 Hz, ±2.5 mm amplitude; 15 Hz ... 100 Hz: 2.3 g 90 Min. (in accordance with IEC 60068-2-6)
Shock	18 ms, 30g, in each space direction (according to IEC 60068-2-27)
Degree of pollution	2
Climatic class	3K3 (in acc. with EN 60721)
Overvoltage category	
EN 61010-1/EN 61010-2-201 (≤ 5000 m)	II
EN 62477-1 (≤ 2000 m)	III

Standards

Safety of power supply units up to 1100 V (insulation distances)	DIN EN 61558-2-16
Electrical safety (of control and regulation devices)	IEC 61010-1
SELV	IEC 61010-1 (SELV) IEC 61010-2-201 (PELV)
Safe isolation	IEC 61558-2-16 IEC 61010-2-201

Approvals

UL	UL Listed UL 61010-1 UL Listed UL 61010-2-201 UL 1310 Class 2 Power Units
SIQ	CB-Scheme (IEC 61010-1, IEC 61010-2-201)



Current approvals/permissions for the product can be found in the download area under phoenixcontact.net/products

Electromagnetic compatibility		
CE basic standard	Minimum normative requirements	Higher requirements in practice (covered)
Conducted noise emission EN 55016	EN 61000-6-4 (Class A)	EN 61000-6-3 (Class B)
Noise emission EN 55016	EN 61000-6-4 (Class A)	EN 61000-6-3 (Class B)
Harmonic currents EN 61000-3-2	not required	0 kHz ... 2 kHz
Flicker EN 61000-3-3	not required	0 kHz ... 2 kHz
CE basic standard	Minimum normative requirements of EN 61000-6-2 (CE) (immunity for industrial environments)	Higher requirements in practice (covered)
Electrostatic discharge EN 61000-4-2		
Housing contact discharge	4 kV (Test Level 2)	8 kV (Test Level 4)
Housing air discharge	8 kV (Test Level 3)	8 kV (Test Level 3)
Comments	Criterion B	Criterion A
Electromagnetic HF field EN 61000-4-3		
Frequency range	80 MHz ... 1 GHz	80 MHz ... 1 GHz
Test field strength	10 V/m (Test Level 3)	20 V/m
Frequency range	1.4 GHz ... 2 GHz	1 GHz ... 6 GHz
Test field strength	3 V/m (Test Level 2)	10 V/m (Test Level 3)
Frequency range	2 GHz ... 2.7 GHz	
Test field strength	1 V/m (Test Level 1)	
Comments	Criterion B	Criterion A
Fast transients (burst) EN 61000-4-4		
Input	2 kV (Test Level 3 - asymmetrical)	4 kV (Test Level 4 - asymmetrical)
Output	2 kV (Test Level 3 - asymmetrical)	4 kV (Test Level 4 - asymmetrical)
Signal	1 kV (Test Level 3 - asymmetrical)	4 kV (Test Level 4 - asymmetrical)
Comments	Criterion B	Criterion B
Surge current loads (surge) EN 61000-4-5		
Input	1 kV (Test Level 3 - symmetrical) 2 kV (Test Level 3 - asymmetrical)	2 kV (Test Level 4 - symmetrical) 4 kV (Test Level 4 - asymmetrical)
Output	0.5 kV (Test Level 2 - symmetrical) 0.5 kV (Test Level 1 - asymmetrical)	1 kV (Test Level 3 - symmetrical) 2 kV (Test Level 3 - asymmetrical)

CE basic standard	Minimum normative requirements of EN 61000-6-2 (CE) (immunity for industrial environments)	Higher requirements in practice (covered)
Signal	0.5 kV (Test Level 2 - symmetrical) 0.5 kV (Test Level 1 - asymmetrical)	2 kV (Test Level 4 - symmetrical) 4 kV (Test Level 4 - asymmetrical)
Comments	Criterion B	Criterion A
Conducted interference EN 61000-4-6		
Input/Output/Signal	asymmetrical	asymmetrical
Frequency range	0.15 MHz ... 80 MHz	0.15 MHz ... 80 MHz
Voltage	10 V (Test Level 3)	10 V (Test Level 3)
Comments	Criterion A	Criterion A
Power frequency magnetic field EN 61000-4-8		
	50 Hz , 60 Hz (30 A/m)	16.67 Hz , 50 Hz , 60 Hz (100 A/m 60 s)
	not required	50 Hz , 60 Hz (1 kA/m , 3 s)
	not required	0 Hz (300 A/m , DC, 60 s)
Comments	Criterion A	Criterion A
Voltage dips EN 61000-4-11		
Input voltage (100 V AC , 60 Hz)		
Voltage dip	70 % , 25 periods (Test Level 2)	70 % , 0.5, 1.25 periods (Test Level 2)
Comments	Criterion C	Criterion B
Voltage dip	40 % , 10 periods (Test Level 2)	40 % , 5, 10, 50 periods (Test Level 2)
Comments	Criterion C	Criterion B
Voltage dip	0 % , 1 period (Test Level 2)	0 % , 0.5, 1, 5, 50 periods (Test Level 2)
Comments	Criterion B	Criterion B
Basic standard	Minimum normative requirements of EN 61000-6-5 (power station equipment, zone 1, 2)	Higher requirements in practice (covered)
Pulse-shape magnetic field EN 61000-4-9		
	not required	1000 A/m
Comments	none	Criterion A
Attenuated sinusoidal oscillations (ring wave) EN 61000-4-12		
Input	1 kV (symmetrical)	2 kV (symmetrical)
	2 kV (asymmetrical)	4 kV (asymmetrical)

Basic standard	Minimum normative requirements of EN 61000-6-5 (power station equipment, zone 1, 2)	Higher requirements in practice (covered)
Comments	Criterion B	Criterion B
Asymmetrical conducted disturbance variables EN 61000-4-16		
Input, Output, Signals	50 Hz , 60 Hz , 10 V (Permanent) (Test Level 3)	16.67 Hz , 50 Hz , 30 V (Permanent) (Test Level 3)
	16.67 Hz , 50 Hz , 60 Hz , 150 Hz , 100 V (1 s) (Test Level 4)	16.67 Hz , 50 Hz , 60 Hz , 300 V (1 s) (Test Level 4)
Comments	Criterion A	Criterion A
Attenuated oscillating wave EN 61000-4-18		
Input, Output	0.5 kV (symmetrical)	1 kV (symmetrical)
	1 kV (asymmetrical)	2.5 kV (asymmetrical)
Comments	none	Criterion B

Key

- Criterion A Normal operating behavior within the specified limits.
- Criterion B Temporary impairment to operational behavior that is corrected by the device itself.
- Criterion C Temporary adverse effects on the operating behavior, which the device corrects automatically or which can be restored by actuating the operating elements.

5 Safety and installation notes

Symbols used

Instructions and possible hazards are indicated by corresponding symbols in this document.



This is the safety alert symbol. It is used to alert you to potential personal injury hazards. Obey all safety measures that follow this symbol to avoid possible personal injuries.

There are different categories of personal injury that are indicated by a signal word.



WARNING

This indicates a hazardous situation which, if not avoided, could result in death or serious injury.



CAUTION

This indicates a hazardous situation which, if not avoided, could result in minor or moderate injury.

The following symbols are used to indicate potential damage, malfunctions, or more detailed sources of information.



NOTE

This symbol together with the signal word NOTE and the accompanying text alert the reader to a situation which may cause damage or malfunction to the device, hardware/software, or surrounding property.



This symbol and the accompanying text provide the reader with additional information or refer to detailed sources of information.

Safety notes and warning instructions



WARNING: Danger to life by electric shock!

- Only skilled persons may install, start up, and operate the device.
- Never carry out work when voltage is present.
- Establish connection correctly and ensure protection against electric shock.
- Cover termination area after installation in order to avoid accidental contact with live parts (e. g., installation in control cabinet).



NOTE

- Observe the national safety and accident prevention regulations.
- Assembly and electrical installation must correspond to the state of the art.
- The power supply is a built-in device and is designed for mounting in a control cabinet.
- The IP20 degree of protection of the device is intended for use in a clean and dry environment.
- Observe mechanical and thermal limits.
- Horizontal mounting position (normal mounting position)
- Mount the power supply unit in the standard installation position. Position of the L/N connection terminal blocks at bottom.
- Ensure that the primary-side wiring and secondary-side wiring are the correct size and have sufficient fuse protection.
- For the connection parameters for wiring the power supply, such as the required stripping length with and without ferrule, refer to the technical data section.
- Use copper cables for operating temperatures of >75 °C (ambient temperature <55 °C)
>90 °C (ambient temperature <75 °C).
- The power supply is approved for the connection to TN, TT and IT power grids (star networks) with a maximum phase-to-phase voltage of 240 V AC
- Protect the device against foreign bodies penetrating it, e.g., paper clips or metal parts.
- The power supply is maintenance-free. Repairs may only be carried out by the manufacturer. The warranty no longer applies if the housing is opened.
- The power supply may only be used for its intended use.

6 High-voltage test (HIPOT)

This protection class II power supply is subject to the Low Voltage Directive and is factory tested. During the HIPOT test (high-voltage test), the insulation between the input circuit and output circuit is tested for the prescribed electric strength values, for example. The test voltage in the high-voltage range is applied at the input and output terminal blocks of the power supply. The operating voltage used in normal operation is a lot lower than the test voltage used.



High-voltage tests up to 2 kV AC / 2.8 kV DC can be performed as described.

The test voltage should rise and fall in ramp form. The relevant rise and fall time of the ramp should be at least two seconds.

6.1 High-voltage dielectric test (dielectric strength test)

In order to protect the user, power supplies (as electric components with a direct connection to potentially hazardous voltages) are subject to more stringent safety requirements. For this reason, permanent safe electrical isolation between the hazardous input voltage and the touch-proof output voltage as safety extra-low voltage (SELV) must always be ensured.

In order to ensure permanent safe isolation of the AC input circuit and DC output circuit, high-voltage testing is performed as part of the safety approval process (type test) and manufacturing (routine test).

6.2 High-voltage dielectric test during the manufacturing process

During the manufacturing process for the power supply, a high-voltage test is performed as part of the dielectric test in accordance with the specifications of IEC/UL/EN 61010-1. The high-voltage test is performed with a test voltage of at least 3 kV AC / 4.2 kV DC or higher. Routine manufacturing tests are inspected regularly by a certification body.

6.3 High-voltage dielectric test performed by the customer

Apart from routine and type tests to guarantee electrical safety, the end user does not have to perform another high-voltage test on the power supply as an individual component. According to EN 60204-1 (Safety of machinery - Electrical equipment of machines) the power supply can be disconnected during the high-voltage test and only installed once the high-voltage test has been completed.

6.3.1 Performing high-voltage testing

If high-voltage testing of the control cabinet or the power supply as a stand-alone component is planned during final inspection and testing, the following features must be observed.

- The power supply wiring must be implemented as shown in the wiring diagram.
- The maximum permissible test voltages must not be exceeded.

Avoid unnecessary loading or damage to the power supply due to excessive test voltages.

i For the relevant applicable test voltages and insulation distances, refer to the corresponding table (see technical data: electric strength of the insulation section).

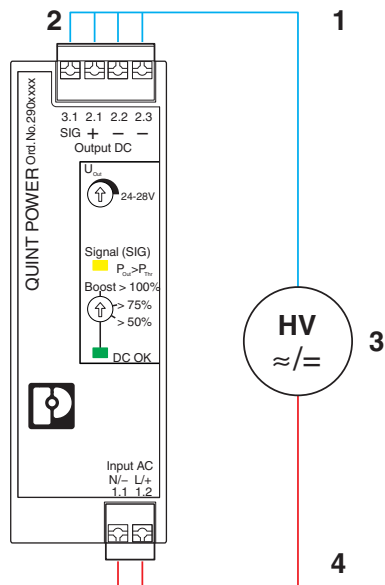

Figure 1 Potential-related wiring for the high-voltage test

Key

No.	Designation	Color coding	Potential levels
1	DC output circuit	Blue	Potential 1
2	Signal contacts	Blue	Potential 1
3	High-voltage tester	--	--
4	AC input circuit	Red	Potential 2

7 Structure of the power supply

The fanless convection-cooled power supply can be snapped onto all DIN rails according to EN 60715.

7.1 Function elements

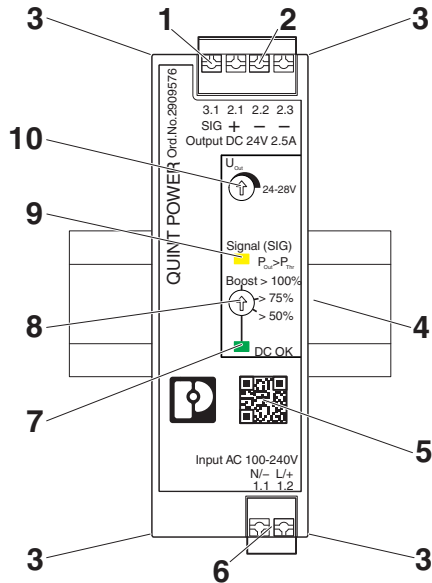

Figure 2 Operating and indication elements

Key

No.	Designation
1	Connection terminal block signal output (SIG) DC OK, $P_{Out} > P_{Thr}$: +24 V DC, 30 mA
2	Connection terminal block output voltage: Output DC +/-
3	Accommodation for cable binders
4	Integrated snap-on foot for carrier rail mounting
5	QR code web link
6	Connection terminal block input voltage: Input L/N
7	Signaling DC OK LED
8	Rotary selector, status of the output voltage (DC OK) or output power ($P_{Out} > P_{Thr}$)
9	Signaling $P_{Out} > P_{Thr}$ LED (yellow): output power $P_{Out} >$ output power threshold P_{Thr}
10	Potentiometer output voltage

7.2 Device dimensions

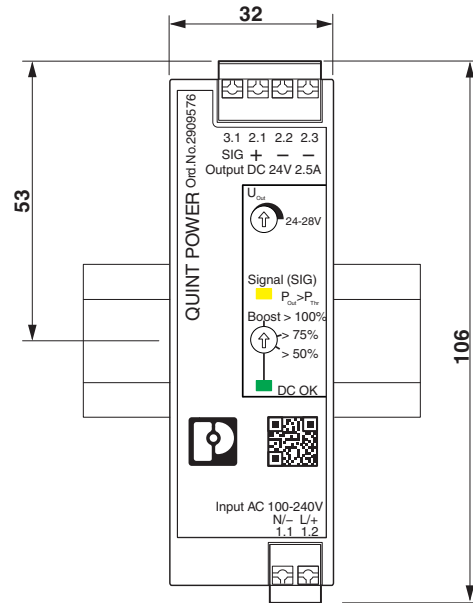

Figure 3 Device dimensions (dimensions in mm)

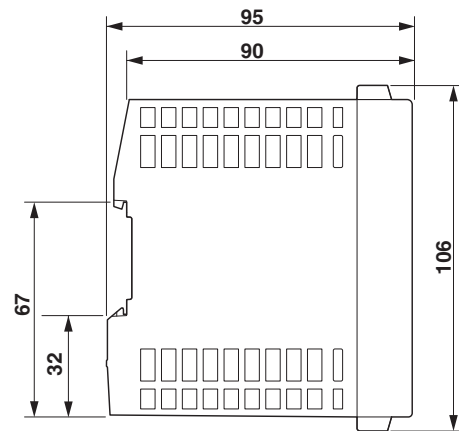

Figure 4 Device dimensions (dimensions in mm)

7.3 Keep-out areas

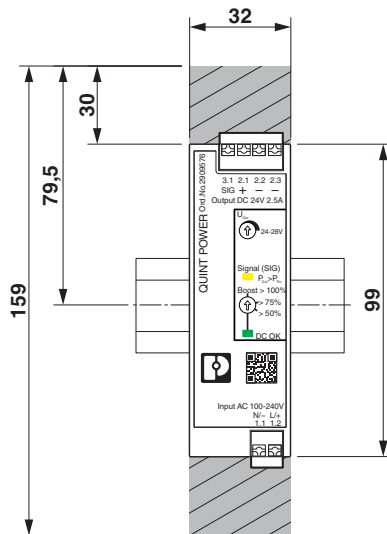

Figure 5 Device dimensions and minimum keep-out areas (in mm)

The minimum clearance to other devices to the left and right is 0 mm.

7.4 Block diagram

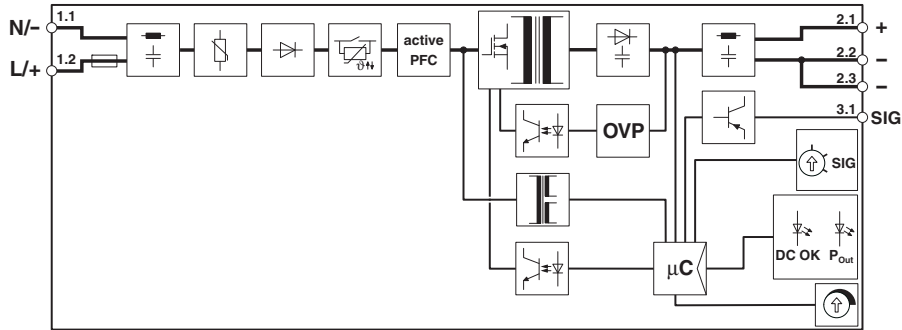

Figure 6 Block diagram

Key

Symbol	Designation
	Filter
	Current limitation
	Rectification
	Inrush current limitation
	Power factor correction (PFC)
	Switching transistor and main transmitter (electrically isolating)
	Secondary rectification and smoothing
	Auxiliary converter (electrically isolating)

Symbol	Designation
	Optocoupler (electrically isolating)
	Additional regulatory protection against surge voltage
	Microcontroller
	PNP transistor switch output
	Rotary selector switch
	Signal/display LEDs (P _{Out} , DC OK)
	Potentiometer output voltage

8 Mounting/removing the power supply

8.1 Mounting the power supply unit

Proceed as follows to mount the power supply:

1. The power supply is mounted in the normal mounting position from above onto the 35 mm DIN rail (DIN EN 60715). Make sure that the integrated snap-on foot is in the correction position behind the DIN rail (A).
2. Then press the power supply down until the integrated snap-on foot audibly latches into place (B).
3. Check that the power supply is securely attached to the DIN rail.

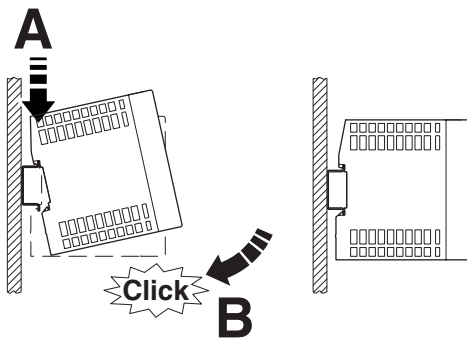

Figure 7 Snapping the power supply onto the DIN rail

8.2 Removing the power supply unit

Proceed as follows to remove the power supply:

1. Take a suitable screwdriver and insert this into the lock hole on the integrated snap-on foot (A).
2. Release the lock by lifting the screwdriver (B).
3. Carefully swivel the power supply forward (C) so that the lock slides back into the starting position.
4. Then separate the power supply from the DIN rail (D).

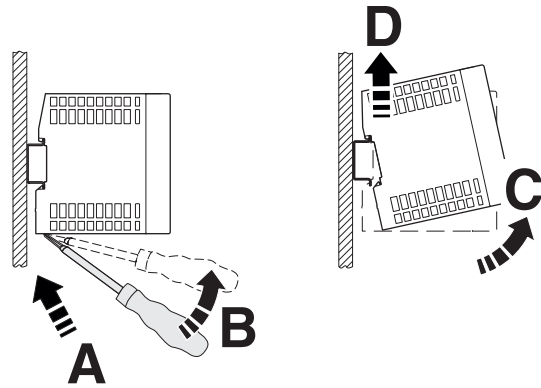

Figure 8 Removing the power supply from the DIN rail

8.3 Fix connection wiring to the power supply

Two receptacles for the bundled attachment of the connection wiring are integrated in the left and right housing panel. Use cable binders to secure the connection wiring (optional PKB 140X3,6 - Order No. 1005460).

Proceed as follows to secure the connection wiring:

- Wire the power supply with sufficient connection reserve (input terminal blocks, output terminal blocks, signal terminal block)
- Bundle and set up the connection wiring so that the ventilation slits on the top and bottom of the housing are covered as little as possible.
- Thread the cable binders into the necessary receptacles for the cable binders.

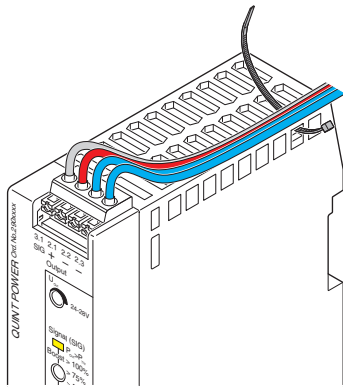

Figure 9 Lay and align connection wiring

- Secure the connection wiring with the cable binders. Make sure that the connection wiring is attached safely and securely without damaging the connection wiring.

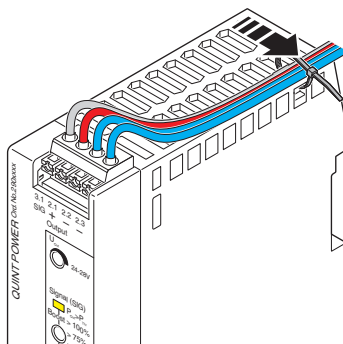

Figure 10 Secure connection wiring with cable binder

- Shorten the excess length of the cable binder ends.
- Then check again that the connection wiring is properly secured.

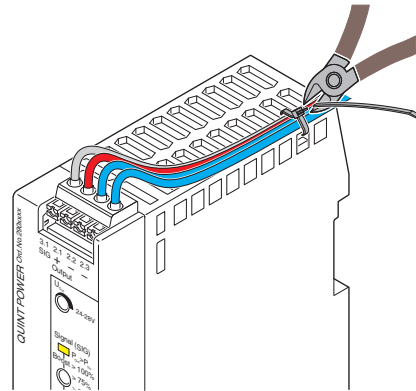

Figure 11 Shorten protruding ends of the cable binder



NOTE: Mechanical damage to the connection wiring caused by friction

In extreme ambient conditions, e.g., strong vibrations, protect the connection wiring against mechanical damage using additional insulation material. The additional insulation material for protecting the connection wiring is limited to the area where the cable binders are attached.

9 Device connection terminal blocks

The AC input and DC output terminal blocks on the front of the power supply feature Push-in connection technology.



For the necessary connection parameters for the connection terminal blocks, refer to the technical data section.

9.1 Input

The power supply is operated on single-phase AC systems or two outer conductors of three-phase systems. The power supply is connected on the primary side via the INPUT L/N connection terminal blocks.



The power supply is approved for connection to TN, TT, and IT power grids with a maximum phase-to-phase voltage of 240 V AC.

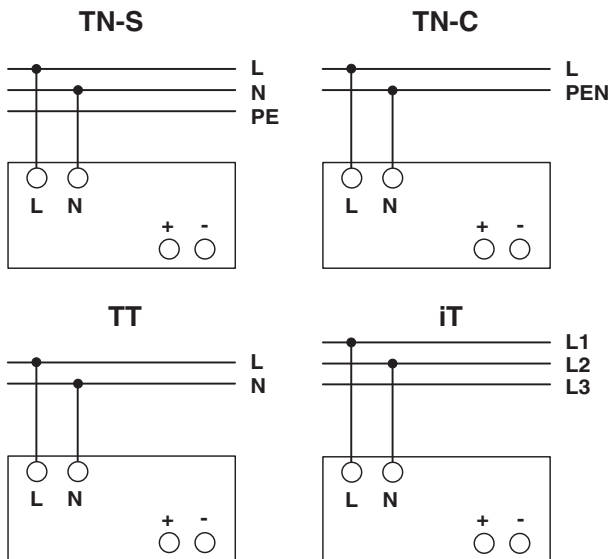

Figure 12 Network configurations in star network

9.2 Protection of the primary side

Installation of the device must correspond to EN 61010 regulations. It must be possible to switch off the device using a suitable disconnecting device outside the power supply. The line protection on the primary side is suitable for this (see technical data section).



DANGER: Hazardous voltage

An all-pos. fuse must be present for operation on three-phase and DC systems.

Protection for AC supply

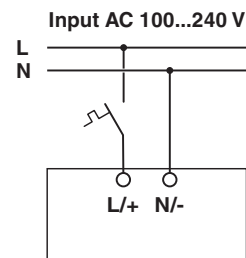

Figure 13 Pin assignment for AC supply voltage

Protection for DC supply

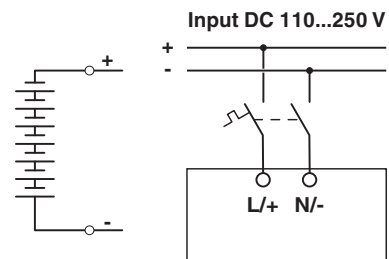

Figure 14 Pin assignment for DC supply voltage

9.3 Output

By default, the power supply is pre-set to a nominal output voltage of 24 V DC.

The output voltage is adjusted using the potentiometer.

9.4 Protection of the secondary side

The power supply is electronically short-circuit-proof and no-load-proof. In the event of an error, the output voltage is limited



If sufficiently long connecting cables are used, fuse protection does not have to be provided for each individual load.

If each load is protected separately with its own protective device, the selective shutdown in the event of a fault enables the system to remain operational.

10 Output characteristic curves

The U/I output characteristic curve is optimized for the following applications:

- When supplying loads with high switch-on currents, such as motors. The dynamic boost of the power supply supplies up to 200% of the nominal power for 5 s. This ensures that sufficient reserve energy is available; overdimensioning of the power supply is not necessary.
- For system extension. With the static boost, up to 125% of the nominal output power is available for a sustained period (up to 40°C).
- For fast energy storage charging (e.g., of batteries) to supply a wide range of loads. The power supply operates in the nominal operating range. Energy supply to the load is ensured.

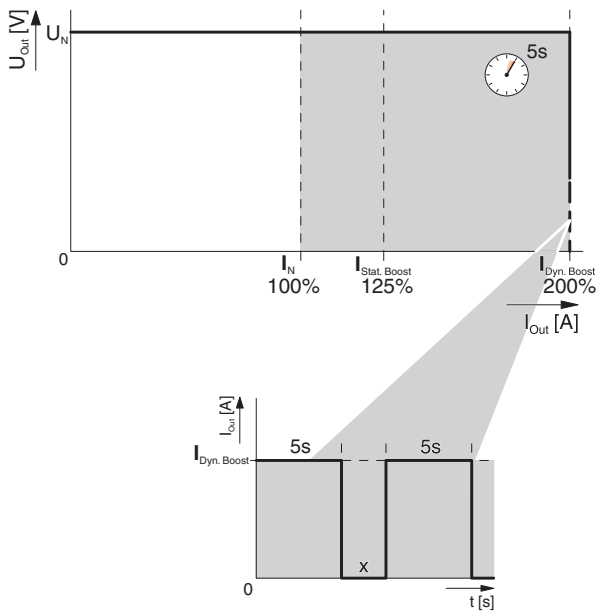

Figure 15 U/I output characteristic curve

11 Boost currents

The power supply provides the static boost ($I_{Stat.Boost}$) for a sustained load supply or the time-limited dynamic boost ($I_{Dyn.Boost}$).

11.1 Static Boost

For system expansion purposes, the sustained static boost ($I_{Stat.Boost}$) supports the load supply with up to 125% of the nominal current of the power supply. Due to the self-heating caused by heat from electrical current, the static boost can be used at ambient temperatures of $\leq 40^\circ\text{C}$.

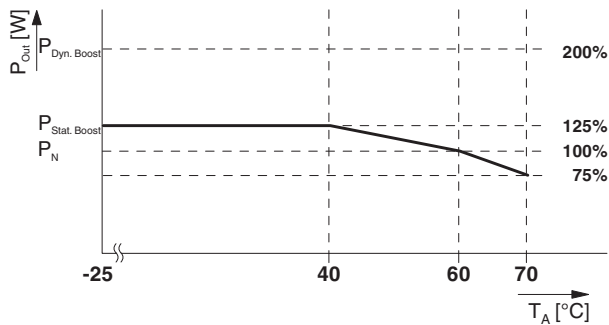

Figure 16 Performance characteristic in static boost

11.2 Dynamic Boost

Dynamic boost ($I_{Dyn.Boost}$) delivers up to 200% of the power supply nominal current to supply high loads. This temporary power supply to the load lasts a maximum of 5 s at an ambient temperature of up to 60°C .

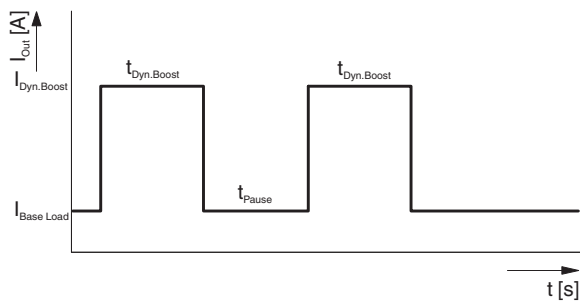

Figure 17 Basic curve of the dynamic boost process

12 Signaling

For signaling and the functional monitoring of the power supply two LEDs and an active signal output are available. Using the rotary selector select the required functional monitoring. The monitoring of the output voltage (DC OK) or the exceedance of the output power threshold are available ($P_{Out} > P_{Thr}$).

12.1 Rotary selector switch in position DC OK:

In this switch position the output voltage (U_{Out}) is monitored. If the DC OK threshold is exceeded ($U_{Out} > 0.9 \times U_{Set}$) the green DC OK LED turns on. Additionally, the signal output (SIG) "active high" is active. If the output voltage drops below the DC OK threshold value ($U_{Out} < 0.9 \times U_{Set}$), the DC OK LED flashes. The signal output is switched to "active low".

12.2 Rotary selector switch in position >50 %, >75 % or boost >100 %:

In each of these switch positions the output power (P_{Out}) is monitored. When the set threshold is exceeded the yellow LED lights up ($P_{Out} > P_{Thr}$) and the signal output (SIG) switches to "active low".

12.3 Location and function of the signaling elements

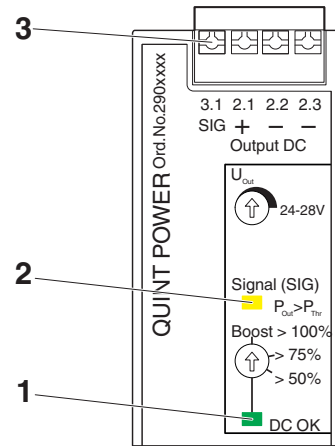

Figure 18 Position of signaling elements

Key

No.	Signaling elements
1	LED status indicator DC OK
	LED on: $U_{Out} > 90\% \times U_{Set}$
	LED flashing: $U_{Out} < 90\% \times U_{Set}$
2	LED $P_{Out} > P_{Thr}$
3	Active signal output

The following table shows the standard assignment for signaling for the U/I characteristic curves which is set by default.

		Normal operation $P_{Out} < P_{Thr}$	BOOST $P_{Out} > P_{Thr}$	Overload operation $U_{Out} < 0.9 \times U_{Set}$	
LED: $P_{Out} > P_{Thr}$	yellow				LED off LED on LED flashing
Signal SIG: $P_{Out} > P_{Thr}$	default	active high	active low	active low	
LED: DC OK	green				
Signal SIG: DC OK	default	active high	active high	active low	

Figure 19 U/I signaling

12.4 Active signal outputs, digital

Signals are routed to a superordinate controller via the digital signal output "3.1 SIG".

The 24 V DC signal is applied between the connection terminal blocks "3.1 SIG" and "2.2 -" or "2.3 -". The maximum load is 30 mA.

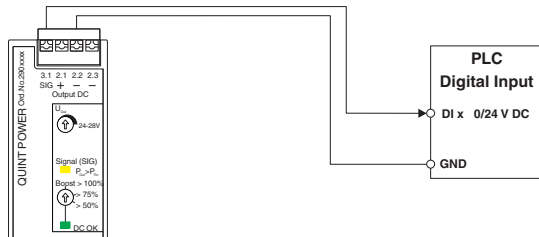

Figure 20 Signaling

12.4.1 Signal level surge protection

IEC 61850-3 Immunity Requirement

Signal connections must satisfy the immunity requirement. Equipment that is installed in "protected" areas and has direct connections to other areas must satisfy the immunity criteria.

Use Phoenix Contact surge protection (Order No. 2905223) when you are using signal connection types p, l, f, and h for the signal paths.

DIN EN 61000-6-5 Electromagnetic Compatibility (EMC)

The interface area may include items such as equipment, devices, apparatus, and systems connected to the outside world.

Use Phoenix Contact surge protection (Order No. 2905223) when you are using connection terminal blocks "3.1 SIG" and "2.2 -" or "2.3 -" for the signals.

(see Section: Technical data, electromagnetic compatibility table)

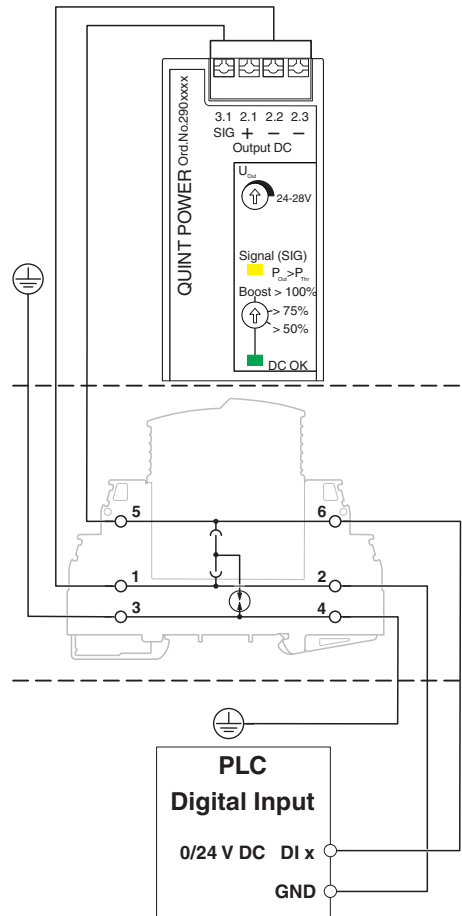

Figure 21 Schematic diagram, signal wiring with TRABTECH surge protection