



Chipsmall Limited consists of a professional team with an average of over 10 year of expertise in the distribution of electronic components. Based in Hongkong, we have already established firm and mutual-benefit business relationships with customers from,Europe,America and south Asia,supplying obsolete and hard-to-find components to meet their specific needs.

With the principle of “Quality Parts,Customers Priority,Honest Operation,and Considerate Service”,our business mainly focus on the distribution of electronic components. Line cards we deal with include Microchip,ALPS,ROHM,Xilinx,Pulse,ON,Everlight and Freescale. Main products comprise IC,Modules,Potentiometer,IC Socket,Relay,Connector.Our parts cover such applications as commercial,industrial, and automotives areas.

We are looking forward to setting up business relationship with you and hope to provide you with the best service and solution. Let us make a better world for our industry!



## Contact us

Tel: +86-755-8981 8866 Fax: +86-755-8427 6832

Email & Skype: info@chipsmall.com Web: www.chipsmall.com

Address: A1208, Overseas Decoration Building, #122 Zhenhua RD., Futian, Shenzhen, China



THIS DRAWING IS UNPUBLISHED.

RELEASED FOR PUBLICATION

20

© COPYRIGHT 20 BY -

ALL RIGHTS RESERVED.

LOC	DIST
-	-

REVISIONS

P	LTR	DESCRIPTION	DATE	DWN	APVD
	D	RELEASED AS PER ECR-11-012557	17JUN2011	MZ	GT
	D1	PARTS -2 -3 1-2 and 1-3 RELEASED FOR PRODUCTION	27JUN2013	KR	JC
	E	UPDATED DRAWING	19DEC2014	KR	MZ

NOTES:

- 1 MATERIAL: POLYAMIDE GLASS FILLED COLOUR NATURAL
- 2 MATERIAL: POLYAMIDE GLASS FILLED COLOUR BLACK
- 3) PACKAGING: SEE TE PACKAGING SPECIFICATION 107-20294
- 4 TE LOGO
- 5 N CODE
- 6 L CODE
- 7 PE CODE
- 8 RATED VOLTAGE
- 9 WIRE SIZE & RATED CURRENT
- 10 AREA FOR AGENCY APPROVAL LOGO
- 11 IP CODE
- 12) SOCKET CAP P/N 293596-1 (SEE DRAWING 293596 FOR REFERENCE) HAS TO BE ASSEMBLED TO GUARANTEE IP40 DEGREE OF PROTECTION WHEN CONNECTOR HOUSING IS NOT MATTED WITH COUNTERPART
- 13 NOT YET RELEASED FOR PRODUCTION
- 14 DATA CODE

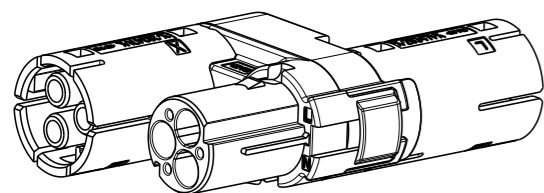
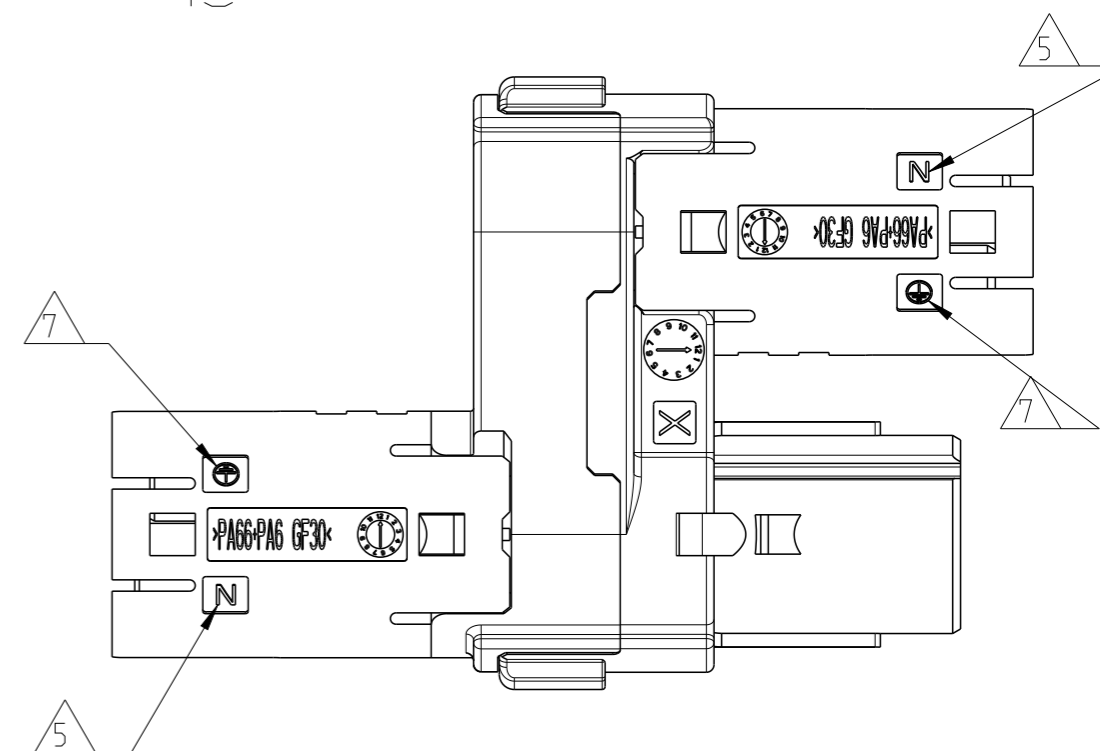
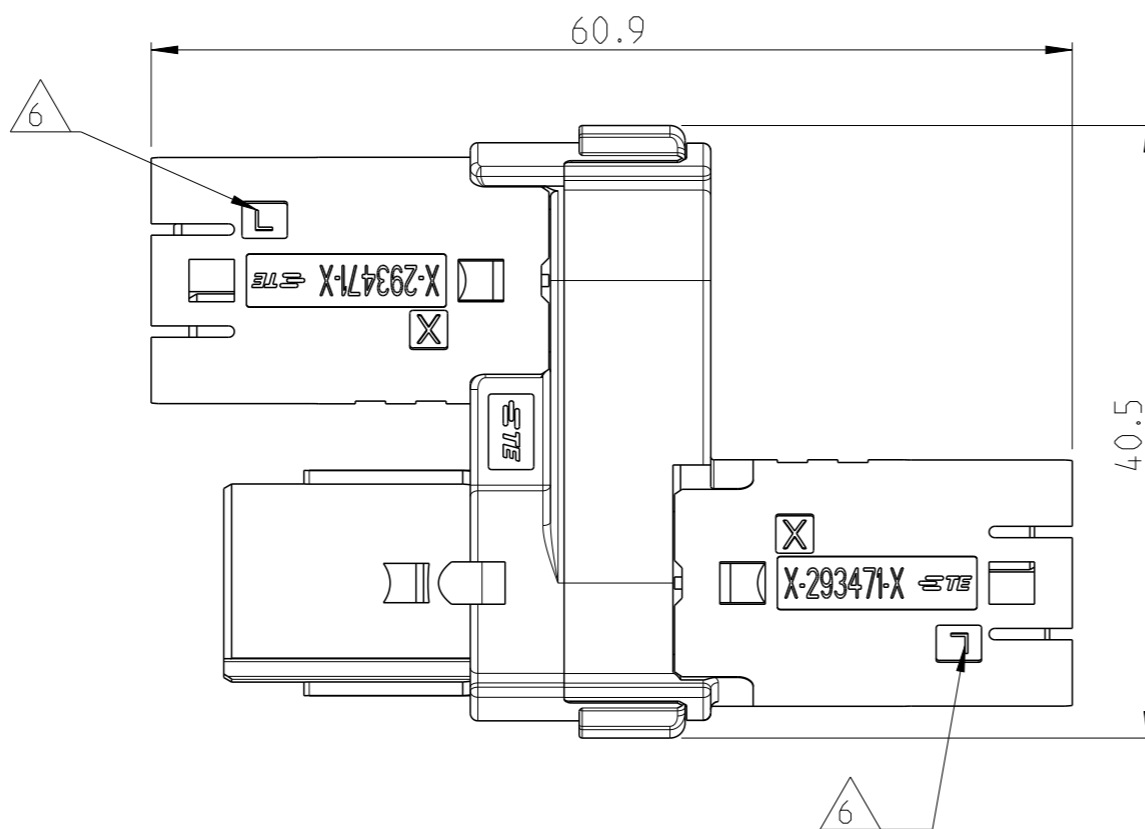
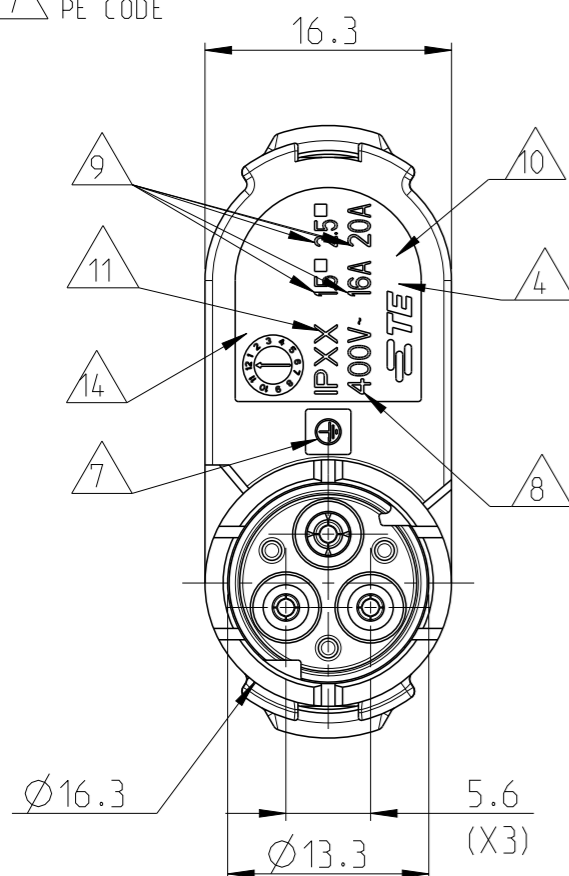
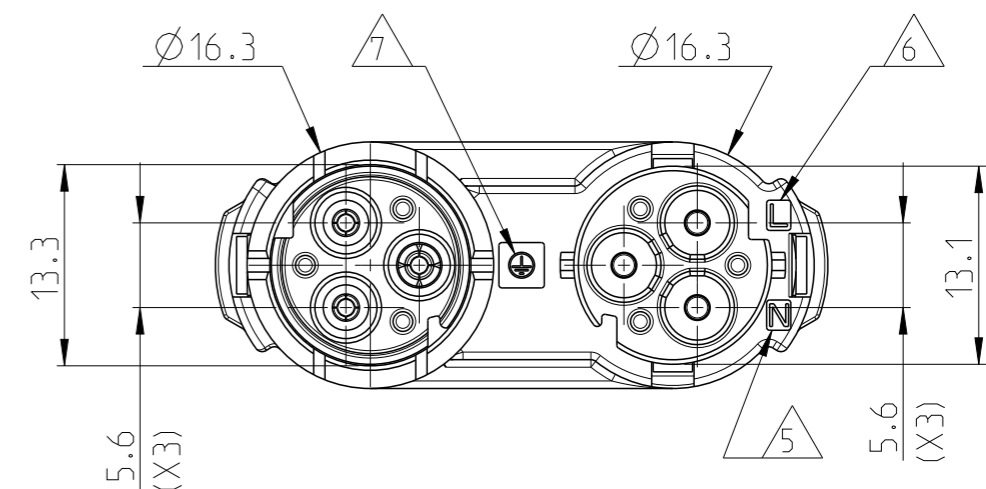

SCALE 1:1

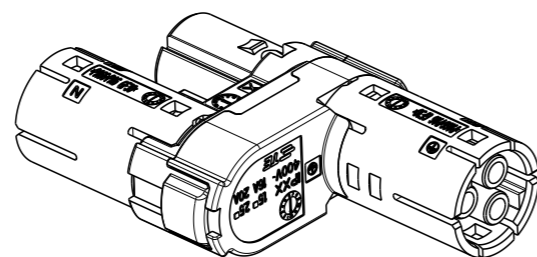

THIS DRAWING IS A CONTROLLED DOCUMENT.

DIMENSIONS:	TOLERANCES UNLESS OTHERWISE SPECIFIED:
mm	
	0 PLC ±0.3
	1 PLC ±0.20
	2 PLC ±0.20
	3 PLC ±0.20
	4 PLC ±0.20
	ANGLES ±3°
MATERIAL	FINISH
-	-

DWN	M. ZUCCA	06OCT2009
CHK	U. AIME	06OCT2009
APVD	G. TURCO	06OCT2009
PRODUCT SPEC	-	-
APPLICATION SPEC	-	-
WEIGHT	-	-



NAME  
T-SPLITTER CONNECTOR  
NECTOR\* M-LINE  
3 POLES UNSEALED VERSION

SIZE	CAGE CODE	DRAWING NO	RESTRICTED TO
A3	00779	C-293611	-

THIS DRAWING IS UNPUBLISHED.

RELEASED FOR PUBLICATION

20









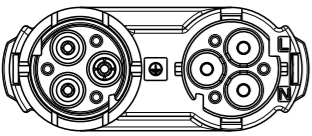
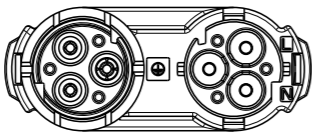
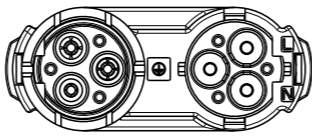
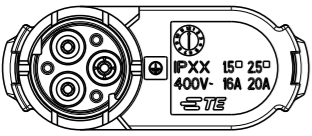
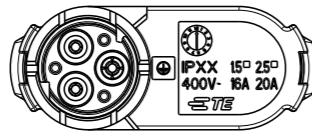
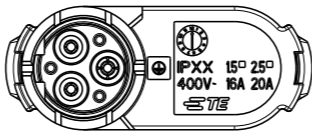
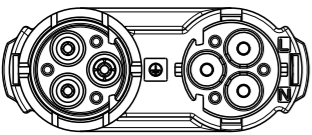
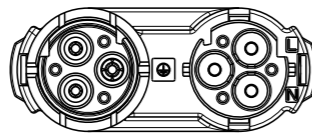
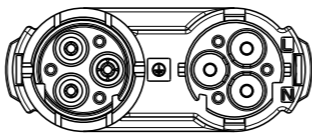
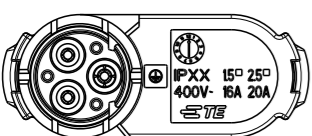
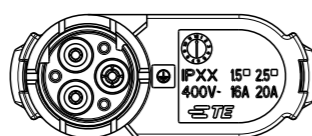
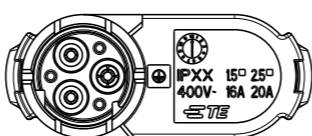

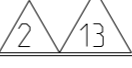

© COPYRIGHT 20 BY -

ALL RIGHTS RESERVED.

LOC	DIST	REVISIONS					
		P	LTR	DESCRIPTION	DATE	DWN	APVD
-	-	-	-	SEE SHEET 1	-	-	-

# POLARIZATION TYPES SCALE 1:1

TYPE "A"	TYPE "B"	TYPE "C"
		
		
P/Ns: 293611-1, 1-293611-1	P/Ns: 293611-2, 1-293611-2	P/Ns: 293611-3, 1-293611-3
TYPE "D"	TYPE "E"	TYPE "F"
		
		
P/Ns: 293611-4, 1-293611-4	P/Ns: 293611-5, 1-293611-5	P/Ns: 293611-6, 1-293611-6

	UNSEALED	F	BLACK	T-SPLITTER CONNECTOR NECTOR* M-LINE	D	1-293611-6
	UNSEALED	E	BLACK	T-SPLITTER CONNECTOR NECTOR* M-LINE	D	1-293611-5
	UNSEALED	D	BLACK	T-SPLITTER CONNECTOR NECTOR* M-LINE	D	1-293611-4
	UNSEALED	C	BLACK	T-SPLITTER CONNECTOR NECTOR* M-LINE	E	1-293611-3
	UNSEALED	B	BLACK	T-SPLITTER CONNECTOR NECTOR* M-LINE	E	1-293611-2
	UNSEALED	A	BLACK	T-SPLITTER CONNECTOR NECTOR* M-LINE	E	1-293611-1
	UNSEALED	F	NATURAL	T-SPLITTER CONNECTOR NECTOR* M-LINE	D	293611-6
	UNSEALED	E	NATURAL	T-SPLITTER CONNECTOR NECTOR* M-LINE	D	293611-5
	UNSEALED	D	NATURAL	T-SPLITTER CONNECTOR NECTOR* M-LINE	D	293611-4
	UNSEALED	C	NATURAL	T-SPLITTER CONNECTOR NECTOR* M-LINE	E	293611-3
	UNSEALED	B	NATURAL	T-SPLITTER CONNECTOR NECTOR* M-LINE	E	293611-2
	UNSEALED	A	NATURAL	T-SPLITTER CONNECTOR NECTOR* M-LINE	E	293611-1
NOTE	VERSION	POL. KEYING	COLOUR	DESCRIPTION	REV.	PART NUMBER

THIS DRAWING IS A CONTROLLED DOCUMENT.

DIMENSIONS:  
mm

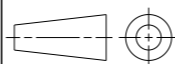

MATERIAL -

TOLERANCES UNLESS OTHERWISE SPECIFIED:

- 0 PLC ±
- 1 PLC ±0.3
- 2 PLC ±0.20
- 3 PLC ±
- 4 PLC ±
- ANGLES ±3°
- FINISH -

DWN M. ZUCCA 06OCT2009

CHK U. AIME 06OCT2009

APVD G. TURCO 06OCT2009

PRODUCT SPEC -

APPLICATION SPEC -

WEIGHT -

Customer Drawing



TE Connectivity

## T-SPLITTER CONNECTOR NECTOR\* M-LINE 3 POLES UNSEALED VERSION

SIZE CAGE CODE DRAWING NO RESTRICTED TO

A3 00779 C=293611

SCALE 1:1 SHEET 2 OF 2 REV E