



Chipsmall Limited consists of a professional team with an average of over 10 year of expertise in the distribution of electronic components. Based in Hongkong, we have already established firm and mutual-benefit business relationships with customers from,Europe,America and south Asia,supplying obsolete and hard-to-find components to meet their specific needs.

With the principle of “Quality Parts,Customers Priority,Honest Operation,and Considerate Service”,our business mainly focus on the distribution of electronic components. Line cards we deal with include Microchip,ALPS,ROHM,Xilinx,Pulse,ON,Everlight and Freescale. Main products comprise IC,Modules,Potentiometer,IC Socket,Relay,Connector.Our parts cover such applications as commercial,industrial, and automotives areas.

We are looking forward to setting up business relationship with you and hope to provide you with the best service and solution. Let us make a better world for our industry!



## Contact us

Tel: +86-755-8981 8866 Fax: +86-755-8427 6832

Email & Skype: info@chipsmall.com Web: www.chipsmall.com

Address: A1208, Overseas Decoration Building, #122 Zhenhua RD., Futian, Shenzhen, China



# QUINT-PS-3x400-500AC/24DC/30

## 3-Phase Primary-Switched Power Supply Unit



### INTERFACE

#### Data Sheet

© PHOENIX CONTACT - 12/2005

#### Description

QUINT POWER devices are 60...960 W DC power supply units for universal use. This is ensured by the wide-range input, single and three-phase versions, and an international approval package.

QUINT POWER stands for guaranteed supply: powerful capacitors ensure mains buffering of more than 20 ms at full load.

All three-phase devices provide the full output power, even in the event of a continuous phase failure.

The POWER BOOST power reserve starts loads with high inrush currents and ensures that fuses are reliably tripped.

Preventive function monitoring diagnoses impermissible operating states and minimizes downtimes in your system. An active transistor output and a floating relay contact are used for remote monitoring.

All QUINT POWER devices are idling-proof and short-circuit proof, and are available with a regulated and adjustable output voltage of 12, 24, and 48 V DC with output currents of 2.5, 5, 10, 20, 30, and 40 A.

Power supply units for use in Ex Zone 2, uninterruptible solutions, AS-i power supply units, and a QUINT diode complete the product range.



QUINT POWER is a built-in device. Installation and startup must only be carried out by qualified personnel. The relevant country-specific regulations (e.g., VDE, DIN) must also be observed.



#### Danger

The device contains dangerous live elements and high levels of stored energy. Never carry out work when the power is turned on.

#### Risk of burns

The housing temperature can reach high values depending on the ambient temperature and the load of the device.



Make sure you always use the latest documentation. It can be downloaded at [www.download.phoenixcontact.com](http://www.download.phoenixcontact.com). A conversion table is available on the Internet at [www.download.phoenixcontact.com/general/7000\\_en\\_00.pdf](http://www.download.phoenixcontact.com/general/7000_en_00.pdf).



This data sheet is valid for all products listed on the following page:

## Ordering Data

### Product

| Description                                | Type                         | Order No.  | Pcs./Pkt. |
|--|------------------------------|------------|-----------|
| 3-phase primary-switched power supply unit | QUINT-PS-3x400-500AC/24DC/30 | 29 38 63 3 | 1         |

## Technical Data

### Input Data

|                                    |   |
|------------------------------------|---|
| Nominal input voltage range        | 3 x 400...500 V AC  |
| Input voltage range                | 320...575 V AC (for all three phases), 450...800 V DC   |
| Frequency range                    | 45...65 Hz (0 Hz at DC input)   |
| Current consumption                | 2.1 A (for all three phases at 400 V AC (nominal load)), approximately 1.7 A (for all three phases at 480 V AC (nominal load)), approximately |
| Inrush current surge               | < 20 A (typical), inrush current limiting/ $I^2t$ (25°C): < 1 A <sup>2</sup> s  |
| Mains buffering (for nominal load) | > 20 ms (at 3 x 400 V AC), > 20 ms (at 3 x 480 V AC)  |
| Typical switch-on time             | < 1 s   |
| Protective circuit                 | Transient surge protection varistor   |
| Input fuse                         | External via 3 circuit breakers 6 A, 10 A or 16 A, Characteristic B   |
| Recommended backup fuse            | 3 x circuit breaker 6 A, 10 A or 16 A, Characteristic B   |
| Discharge current to PE            | < 3.5 mA  |
| Connection method                  | Screw connection  |
| Stripping length                   | 8 mm  |

### Output Data

|  |  |
|--|--|
| Nominal output voltage                   | 24 V DC $\pm$ 1%   |
| Setting range for the output voltage     | 22.5...28.5 V DC   |
| Output current                           | 30 A (-25...+60°C)<br>35 A (with POWER BOOST, -25...+40°C)   |
| Derating                                 | Above +60°C: 2.5% per Kelvin   |
| Current limit                            | $I_{BOOST} = 35$ A (for short circuit), approximately  |
| System deviation                         | < 1% (static load change 10...90%)<br>< 2% (dynamic load change 10...90%)<br>< 0.1% (input voltage change $\pm$ 10%) |
| Power dissipation                        |  |
| Maximum nominal load                     | 62 W   |
| Maximum no load                          | 14 W   |
| Efficiency                               | > 92% for 230 V AC and nominal values  |
| Rise time                                | < 2 ms ( $U_{OUT}$ (10...90%))   |
| Residual ripple/switching peaks (20 MHz) | < 100 mV <sub>pp</sub> (for nominal values)  |
| Parallel connection                      | Yes, to create redundant systems and increase efficiency   |
| Connection method                        | Screw connection   |
| Stripping length                         | 10 mm  |

### DC OK Signal Output, Active

|                    |   |
|--------------------|---|
| Type of output     | Transistor output, $U_{out} > 0.9 \times U_N$ : High signal |
| Continuous current | 40 mA, maximum  |
| Output voltage     | +24 V DC (signal)   |

### DC OK Signal Output, Floating

|                           |  |
|---------------------------|--|
| Type of output            | Relay contact, $U_{out} > 0.9 \times U_N$ : Contact closed |
| Continuous current        | 1 A, maximum   |
| Maximum switching voltage | 30 V AC/DC, maximum  |

**General Data**

|  |  |
|--|--|
| Insulation voltage   |  |
| Input/output   | 4 kV AC (type test)/2 kV AC (routine test)         |
| Input/PE   | 3.5 kV AC (type test)/2 kV AC (routine test)       |
| Insulation voltage output/PE                                 | 500 V DC (routine test)                            |
| Mounting position  | On horizontal NS 35 DIN rail according to EN 60715 |
| Degree of protection   | IP20   |
| Protection class   | I, with PE connection                              |
| MTBF   | > 500,000 h according to IEC 61709 (SN 29500)      |
| Housing version  | AluNox (AlMg1), closed                             |
| Weight   | 3.300 kg   |
| Dimensions (width x height x depth)                          | 240 mm x 130 mm x 125 mm                           |
| Dimensions (width x height x depth) for alternative assembly | 122 mm x 130 mm x 243 mm                           |





**Status Indicators**

|                        |   |
|------------------------|---|
| DC OK status indicator | Green LED ( $U_{out} < 0.9 \times U_N$ : LED flashes) |
|------------------------|---|

**Climatic Data**

|  |   |
|--|---|
| Ambient temperature (operation)          | -25...+70°C (> 60°C derating)   |
| Ambient temperature (storage/transport)  | -40...+85°C   |
| Maximum permissible humidity (operation) | 95% (at +25°C, no condensation)   |
| Vibration (operation)                    | < 15 Hz, amplitude $\pm 2.5$ mm according to IEC 60068-2-6<br>15...150 Hz, 2.3g, 90 minutes |
| Shock                                    | 30g in all space directions, according to IEC 60068-2-27                                    |
| Pollution degree                         | 2 according to EN 50178   |
| Climatic class                           | 3K3 according to EN 60721   |

**Certification/Standards**

|  |  |
|--|--|
| Electrical equipment of machines   | EN 60204 (Surge Voltage Category III)  |
| Safety transformers for switched-mode power supply units   | EN 61558-2-17  |
| Electrical safety (of IT equipment)  | EN 60950/VDE 0805 (SELV)<br>CB Scheme <br>UL/C-UL Recognized UL 60950  |
| Industrial control equipment   | UL/C-UL Listed UL 508   |
| Electrical equipment for potentially explosive areas   | UL/C-UL Recognized UL 1604, Class I, Division 2, Groups A, B, C, D   |
| Shipbuilding   | Germanischer Lloyd  , ABS   |
| Electronic equipment for use in electrical power installations                                   | EN 50178 (VDE 0160)  |
| Safety extra-low voltage   | PELV (EN 60204), SELV (EN 60950)   |
| Safe isolation   | DIN VDE 0100-410, DIN VDE 0106-1010  |
| Protection against electric shock  | DIN 57100-410  |
| Protection against electric shock, basic requirements for safe isolation in electrical equipment | DIN VDE 0106-101   |
| Limitation of harmonic line currents   | According to EN 61000-3-2  |
| Device safety  |  (tested safety)  |



**Conformance With EMC Directive 89/336/EEC and Low Voltage Directive 73/23/EEC**

**Noise Immunity Test According to EN 61000-6-2<sup>1</sup>**

|                               |               |                          |                     |  |
|-------------------------------|---------------|--------------------------|---------------------|--|
| Electrostatic discharge (ESD) | EN 61000-4-2  | Criterion B <sup>2</sup> | Housing             | Level 4  |
|                               |               |                          | Air discharge       | 15 kV  |
|                               |               |                          | Contact discharge   | 8 kV   |
| Electromagnetic HF field      | EN 61000-4-3  | Criterion A <sup>3</sup> | Housing             | Level 3  |
|                               |               |                          | Frequency range     | 80...1000 MHz/1.4...2.0 GHz  |
|                               |               |                          | Field strength      | 10 V/m   |
| Fast transients (burst)       | EN 61000-4-4  | Criterion B <sup>2</sup> | Input               | 4 kV (Inst. Class 4, asymmetrical: Cable to ground)<br>2 kV (Inst. Class 4, symmetrical: Cable to cable) |
|                               |               |                          | Output              | 0.5 kV (Level 1, asymmetrical: Cable to ground)<br>0.5 kV (Level 1, symmetrical: Cable to cable)         |
|                               |               |                          | Signal              | 1 kV (Level 1, asymmetrical: Cable to ground)  |
| Surge current load (surge)    | EN 61000-4-5  | Criterion B <sup>2</sup> | Input               | 4 kV (Level 4, asymmetrical)   |
|                               |               |                          | Output              | 2 kV (Level 3, asymmetrical)   |
|                               |               |                          | Signal              | 1 kV (Level 2, asymmetrical)   |
| Conducted interference        | EN 61000-4-6  | Criterion A <sup>3</sup> | Input/output/signal | Level 3, asymmetrical  |
|                               |               |                          | Frequency range     | 0.15...80 MHz  |
|                               |               |                          | Voltage             | 10 V   |
| Voltage dips                  | EN 61000-4-11 | Criterion B              | Input               | Mains buffering > 20 ms  |

**Noise Emission Test According to EN 61000-6-3**

|                           |                                     |         |                                      |
|---------------------------|-------------------------------------|---------|--------------------------------------|
| Noise emission of housing | EN 55011<br>(EN 55022) <sup>4</sup> | Class B | Industrial and domestic applications |
|---------------------------|-------------------------------------|---------|--------------------------------------|

<sup>1</sup> EN 61000 corresponds to IEC 61000

<sup>2</sup> Criterion B: Temporary adverse effects on the operating behavior, which the device corrects automatically.

<sup>3</sup> Criterion A: Normal operating behavior within the specified limits.

<sup>4</sup> EN 55011 corresponds to CISPR11/EN 55022 corresponds to CISPR22

**Structure**

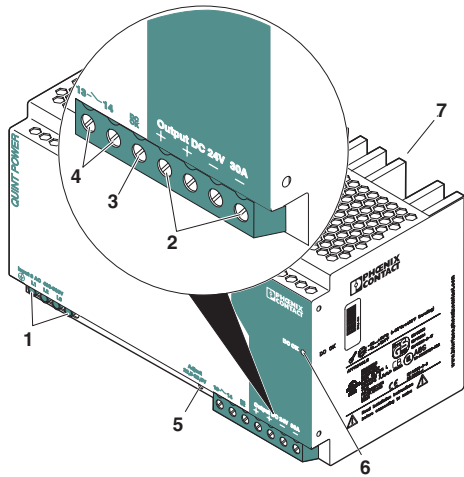

Figure 1 Operating elements

- 1 AC input  
85...264 V AC input voltage,  
45...65 Hz frequency
- 2 DC output  
24 V DC output voltage (default),  
can be set between 22.5 and 28.5 V DC
- 3 DC OK output active
- 4 DC OK output floating
- 5 Potentiometer (covered) 22.5...28.5 V DC
- 6 DC OK LED
- 7 Universal DIN rail adapter UTA 107

**Block Diagram**

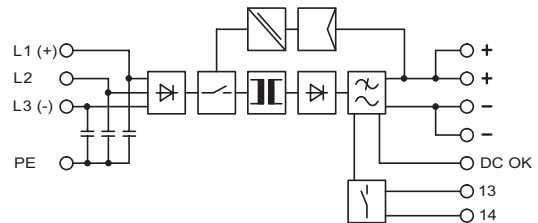

Figure 2 Block diagram

## Safety Notes and Warning Instructions



### Danger

The device contains dangerous live elements and high levels of stored energy.

Never carry out work when the power is turned on.



### Risk of burns

The housing temperature can reach high values depending on the ambient temperature and the load of the device.

To ensure that the device can be operated safely and all functions can be used, please read these instructions carefully.



QUINT POWER is a built-in device. Installation and startup must only be carried out by qualified personnel. The relevant country-specific regulations (e.g., VDE, DIN) must also be observed.



### Before startup please ensure:

- The mains has been connected correctly and protection is provided against electric shock.
- The device can be switched off outside the power supply according to EN 60950 regulations (e.g., by the line protection on the primary side).
- The protective conductor is connected.
- All supply lines have sufficient fuse protection and are the correct size.
- All output cables are the correct size for the maximum device output current or have separate fuse protection.
- Sufficient convection is ensured.

## Installation

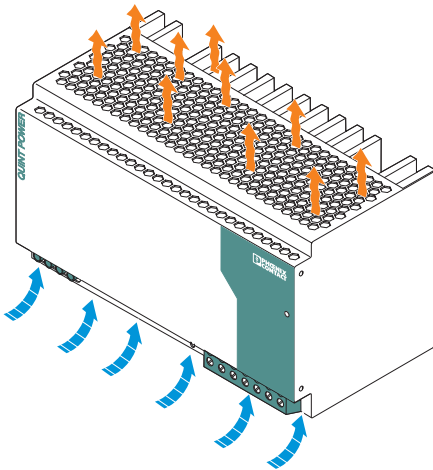

Figure 3 Convection



### Risk of burns

The housing temperature can reach high values depending on the ambient temperature and the load of the device.



To ensure sufficient convection, the following minimum spacing is required between other modules:

5 cm above and below the device.

No minimum spacing to other modules at the sides is required for proper operation of the device.

The power supply unit can be snapped onto all DIN rails according to EN 60715 and must be mounted horizontally (connection terminal blocks facing downwards).

**Mounting Position**

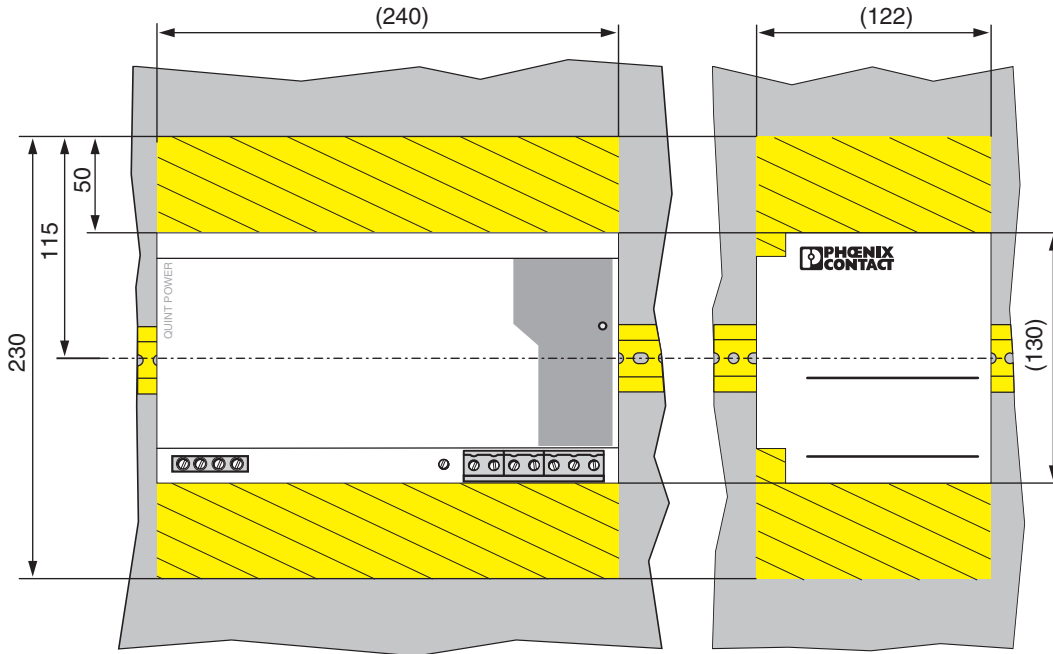

Figure 4 Mounting position (dimensions in mm)

Flat mounting position: Installation depth 125 mm (+ DIN rail)

Narrow mounting position: Installation depth 243 mm (+ DIN rail)

**Flat Mounting Position (Default Upon Delivery)**

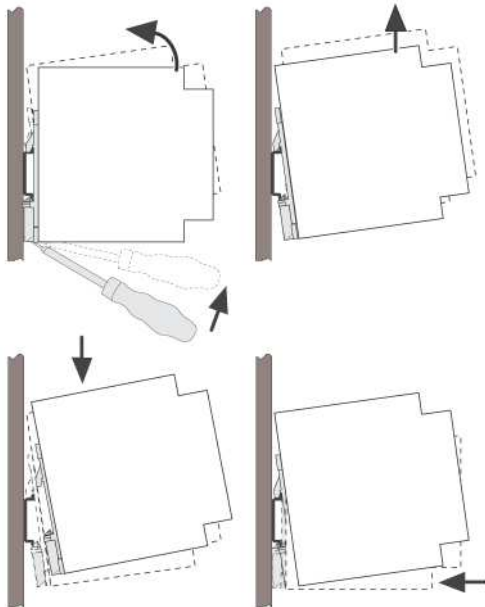

Figure 5 Flat mounting position

**Assembly**

Position the module with the DIN rail guideway on the top edge of the DIN rail and then snap it downwards.

**Removal**

Release the snap-on catch using a screwdriver and then detach the module from the bottom edge of the DIN rail.

**Narrow Mounting Position**

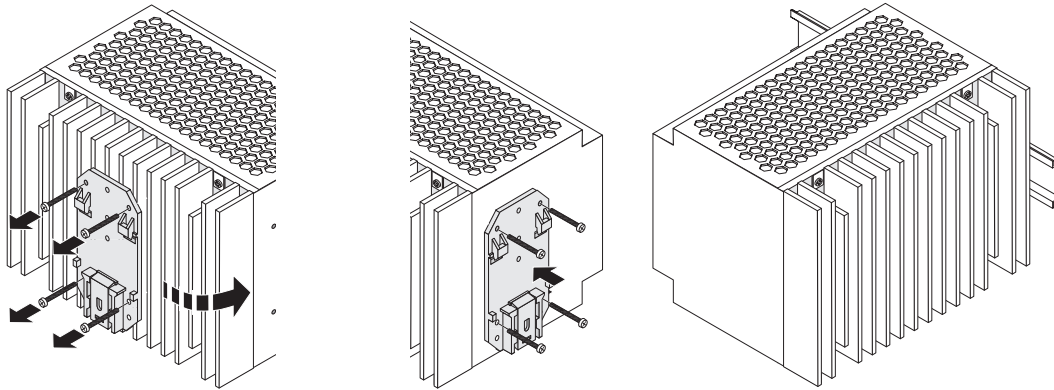

Figure 6 Narrow mounting position

A narrow mounting position can be achieved by mounting the module onto the DIN rail at a 90° angle. Mount the DIN rail adapter (UTA 107) as shown in Figure 6.

No additional assembly material is required.  
Mounting screws: Torx T10 (torque 0.8...0.9 Nm).

**Connection of Various Types of Network: 3 x 400...500 V AC Networks**

Figure 7 illustrates the connection of various types of network. In the event of a phase failure, continuous operation is ensured with nominal power.

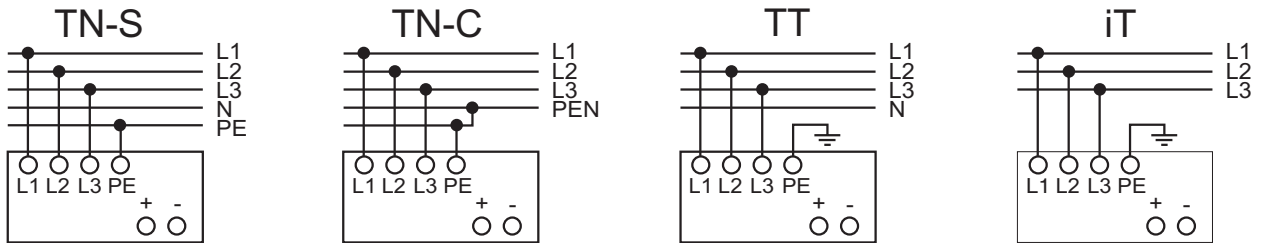

Figure 7 3 x 400...500 V AC networks



## Connection of the Connecting Cable

Use a screwdriver with the correct blade width for wiring. The cable cross sections listed in the table on the right can be connected.

|        | Solid              | Stranded | AWG     | Torque    | Stripping Length |
|--------|--------------------|----------|---------|-----------|------------------|
|        | [mm <sup>2</sup> ] |          |         | [Nm]      | [mm]             |
| Input  | 0.2...6            | 0.2...4  | 25...10 | 0.5...0.6 | 8 mm             |
| Output | 0.5...16           | 0.5...10 | 20...6  | 1.2...1.5 | 10 mm            |
| Signal | 0.5...16           | 0.5...10 | 20...6  | 1.2...1.5 | 10 mm            |

For reliable and safe-to-touch connections, strip the cable ends according to the table.

## Input (1)

The 3 x 400...500 V AC connection is made using the L1, L2, L3, and Ⓧ screw connections.

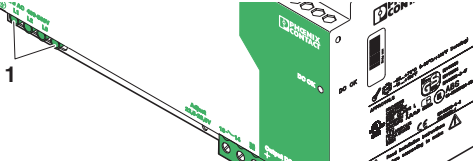

Figure 8 Input

## Fuses

Three external thermomagnetic fuses are required to protect the device. Even in the event of a phase failure, continuous operation is ensured with nominal load.



If an external fuse is blown, this is most probably due to a device fault. In this case, the device should be checked in the factory.

## Recommended Backup Fuse

3 x circuit breaker 6 A, 10 A or 16 A, Characteristic B (or equivalent).



A suitable fuse should be provided for DC applications.

## Protecting the Primary Side

The device must be installed according to the specifications of EN 60950.



It must be possible to switch off the device using a suitable disconnecting device outside the power supply. For example, primary side line protection could be used.

## Output

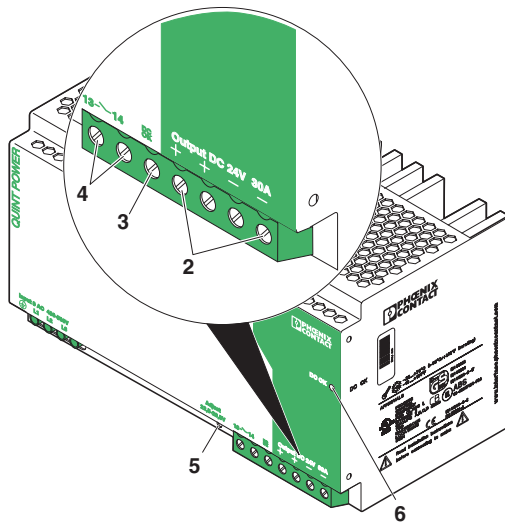

Figure 9 Output

### Connecting the Output

The connection is made using the "+" and "-" screw connections on the screw connection ②. The output voltage set upon delivery is 24 V DC. The output voltage can be set on the potentiometer ⑤.

### Protecting the Secondary Side

The device is electronically short-circuit-proof and idling-proof. In the event of an error, the output voltage is limited to a maximum of 35 V DC.



Make sure that all output cables are the correct size for the maximum output current or have separate fuse protection.

The cable cross sections in the secondary circuit must be large enough to keep the voltage drops on the cables as low as possible.

### Signaling

The two DC OK outputs are for preventive function monitoring of the power supply unit. A floating signal contact ④ and an active DC OK signal ③ are available. In addition, the DC OK LED ⑥ can be used to evaluate the function of the power supply directly at the installation location (see "Status Indicator: DC OK LED" on page 10).

### Floating Contact

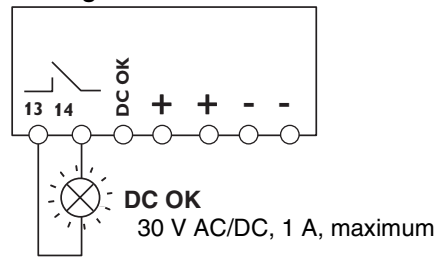

Figure 10 Floating contact

When opened, the floating signal contact indicates that the output voltage has fallen more than 10% below the set value. Signals and ohmic loads up to a maximum of 30 V and currents up to a maximum of 1 A can be switched.



With heavy inductive loads, e.g., a relay, a suitable protective circuit (e.g., free-wheeling diode) is required.

### Active Signal Output

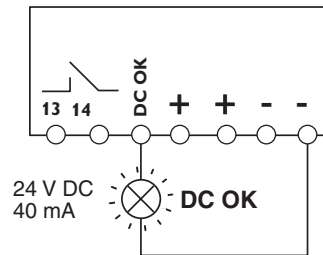

Figure 11 Active signal output

The 24 V DC signal is between the "DC OK" and "-" connection terminal blocks and can be loaded with 40 mA maximum. This signal output indicates that the output voltage has fallen more than 10% below the set value when "active high" changes to "low". The DC OK signal is isolated from the power output. This ensures that a separate supply does not enter from devices connected in parallel. The 24 V DC signal can be connected directly to a logic input for evaluation.

**Signal Loop**

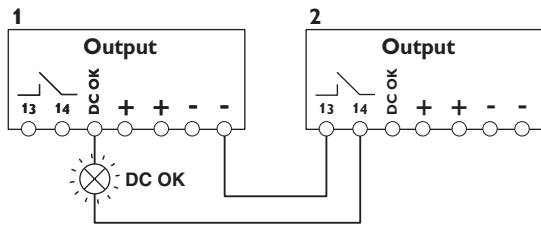

Figure 12 Signal loop

The two signal outputs described above can be easily combined.

**Example:** Monitoring two devices

Use the active alarm output of device 1 and loop in the floating alarm output of device 2. In the event of an error, a group error message is output. Any number of devices can be looped. This signal combination saves wiring costs and logic inputs.

**Status Indicator: DC OK LED**

The green DC OK LED enables local function evaluation in the control cabinet.

| DC OK LED                     | ON   | Flashing  | OFF   |
|-------------------------------|--|---|---|
| Active DC OK switching output | U = +24 V (with reference to "-")                  | U = 0 V (with reference to "-")   | U = 0 V (with reference to "-")   |
| Floating DC OK output         | Closed   | Open  | Open  |
| Cause                         | Output voltage greater than 90% of the set voltage | Output voltage less than 90% of the set voltage   | No voltage at the output  |
| Meaning                       | Output voltage and current OK                      | QUINT POWER operating, but: <ul style="list-style-type: none"> <li>- Error at the load</li> <li>- Current consumption greater than I<sub>BOOST</sub></li> <li>- Output short circuit</li> </ul> | QUINT POWER not operating, because: <ul style="list-style-type: none"> <li>- No mains voltage present</li> <li>- The primary side fuse has blown</li> <li>- The device is faulty</li> </ul> |

**Function**

**Output Characteristic Curve**

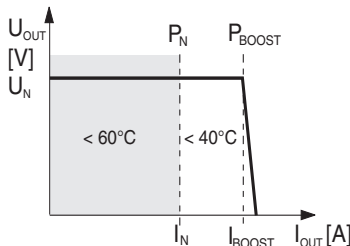

Figure 13 Output characteristic curve

The U/I characteristic curve ensures that both heavy capacitive loads and loads with DC/DC converters can be supplied by QUINT POWER in the input circuit. Connected fuses are tripped. The selectivity in your system configuration is ensured at all times.

- $U_N = +24\text{ V}$
- $I_N = 30\text{ A}$
- $I_{BOOST} = 35\text{ A}$
- $P_N = 720\text{ W}$
- $P_{BOOST} = 840\text{ W}$

At ambient operating temperatures  $T_{amb} < +40^{\circ}C$ , the device can continuously supply an  $I_{BOOST}$  current at nominal voltage. In the event of heavier loads the working point demonstrates the U/I characteristic curve shown in the figure. The output current is limited to  $I_{BOOST}$ . The secondary voltage is reduced until the short circuit on the secondary side is removed.

**Temperature Response**

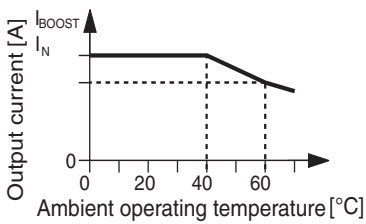

Figure 14 Temperature response

At an ambient operating temperature of up to +40°C, the device continuously supplies the  $I_{BOOST}$  output current.

The device can supply a nominal output current of  $I_N$  up to an ambient operating temperature of +60°C. The output power must be decreased by 2.5% per Kelvin temperature increase for ambient operating temperatures over +60°C.

At ambient operating temperatures above +70°C or in the event of a thermal overload, the device does not switch off. The output power is decreased to such an extent that device protection is provided. Once the device has cooled down, the output power is increased again.

**Parallel Operation**

Devices of the same type can be connected in parallel to increase both redundancy and power. The default setting does not have to be adjusted.



A maximum of five devices can be connected in parallel.

If the output voltage is adjusted, an even current distribution can be ensured by precisely setting all power supply units that are operated in parallel to the same output voltage.

To ensure symmetrical current distribution we recommend that all cable connections from the power supply unit to the DIN rail are the same length and have the same cross section.



Depending on the system, for parallel connection of more than two power supply units a protective circuit should be installed at each individual device output (e.g., decoupling diode or DC fuse). This prevents high return currents in the event of a secondary device fault.

**Redundancy Operation**

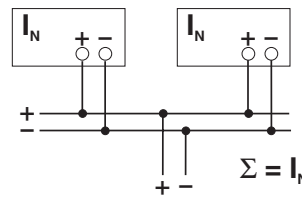

Figure 15 Redundancy operation

Redundant circuits are suitable for supplying systems, which place particularly high demands on operational safety.

If a fault occurs in the primary circuit of the first power supply unit, the second device automatically takes over the entire power supply, without interruption, and vice versa.

For this purpose, the power supply units to be connected in parallel must be large enough that the total current requirements of all loads can be fully met by one power supply unit.



External decoupling diodes are required for 100% redundancy (QUINT-DIODE/40, Order No. 29 38 96 3).

**Increasing Power**

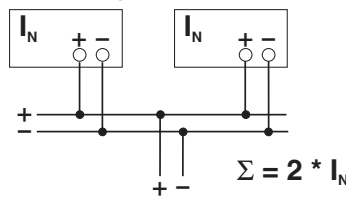

Figure 16 Increasing power

The output current can be increased to  $n \times I_N$  where  $n$  is the number of devices connected in parallel.

Parallel connection for increasing power is used when extending existing systems. A parallel connection is recommended if the power supply unit does not cover the current consumption of the most powerful load.

Otherwise, the loads should be divided over independent individual devices.



A maximum of five devices can be connected in parallel.