



Chipsmall Limited consists of a professional team with an average of over 10 year of expertise in the distribution of electronic components. Based in Hongkong, we have already established firm and mutual-benefit business relationships with customers from,Europe,America and south Asia,supplying obsolete and hard-to-find components to meet their specific needs.

With the principle of "Quality Parts,Customers Priority,Honest Operation,and Considerate Service",our business mainly focus on the distribution of electronic components. Line cards we deal with include Microchip,ALPS,ROHM,Xilinx,Pulse,ON,Everlight and Freescale. Main products comprise IC,Modules,Potentiometer,IC Socket,Relay,Connector.Our parts cover such applications as commercial,industrial, and automotives areas.

We are looking forward to setting up business relationship with you and hope to provide you with the best service and solution. Let us make a better world for our industry!



Contact us

Tel: +86-755-8981 8866 Fax: +86-755-8427 6832

Email & Skype: info@chipsmall.com Web: www.chipsmall.com

Address: A1208, Overseas Decoration Building, #122 Zhenhua RD., Futian, Shenzhen, China



Low $V_{CE(sat)}$

2SA1746

Silicon PNP Epitaxial Planar Transistor

Application : Chopper Regulator, Switch and General Purpose

■ Absolute maximum ratings (Ta=25°C)

Symbol	Ratings	Unit
V_{CB0}	-70	V
V_{CE0}	-50	V
V_{EB0}	-6	V
I_C	-12(Pulse-20)	A
I_B	-4	A
P_C	60(Tc=25°C)	W
T_j	150	°C
T_{stg}	-55 to +150	°C

■ Electrical Characteristics (Ta=25°C)

Symbol	Conditions	Ratings	Unit
I_{CB0}	$V_{CB} = -70V$	-10max	μA
I_{EB0}	$V_{EB} = -6V$	-10max	μA
$V_{(BR)CEO}$	$I_C = -25mA$	-50min	V
h_{FE}	$V_{CE} = -1V, I_C = -5A$	50min	
$V_{CE(sat)}$	$I_C = -5A, I_B = -80mA$	-0.5max	V
$V_{BE(sat)}$	$I_C = -5A, I_B = -80mA$	-1.2max	V
f_T	$V_{CE} = -12V, I_E = 1A$	25typ	MHz
COB	$V_{CB} = -10V, f = 1MHz$	400typ	pF

External Dimensions FM100(TO3PF)

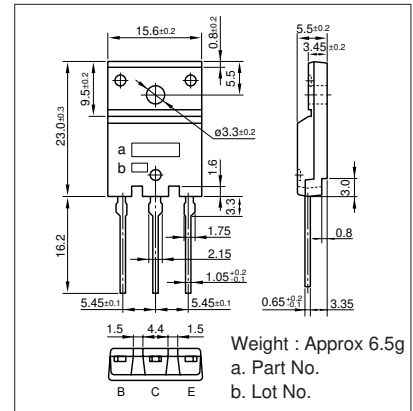

■ Typical Switching Characteristics (Common Emitter)

V_{CC} (V)	R_L (Ω)	I_C (A)	V_{BB1} (V)	V_{BB2} (V)	I_{B1} (mA)	I_{B2} (mA)	t_{on} (μs)	t_{stg} (μs)	t_f (μs)
-20	4	-5	-10	5	-80	80	0.5typ	0.6typ	0.3typ

$I_C - V_{CE}$ Characteristics (Typical)

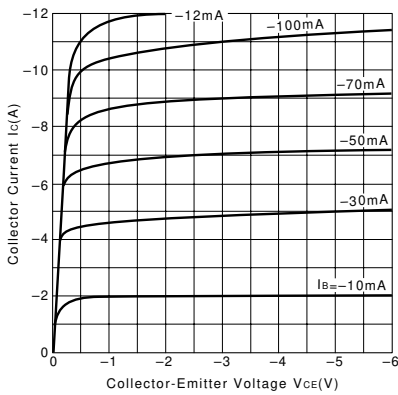

$V_{CE(sat)} - I_B$ Characteristics (Typical)

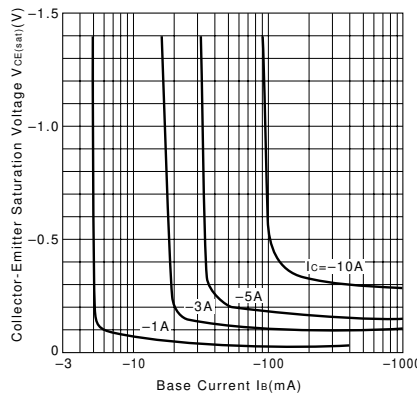

$I_C - V_{BE}$ Temperature Characteristics (Typical)

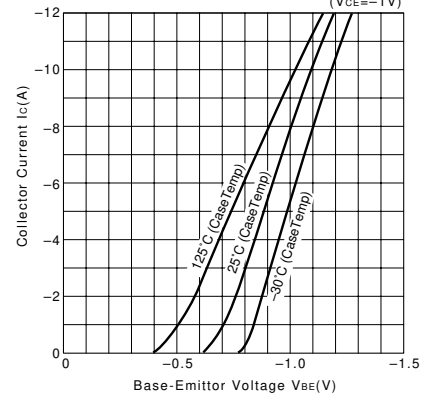

$h_{FE} - I_C$ Characteristics (Typical)

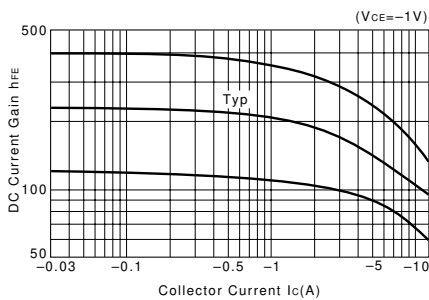

$h_{FE} - I_C$ Temperature Characteristics (Typical)

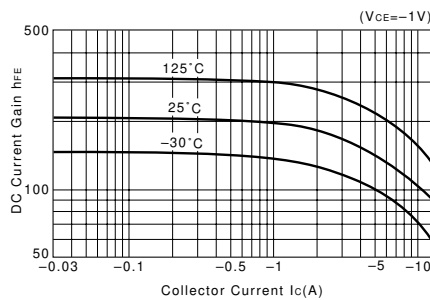

θ_{j-a-t} Characteristics

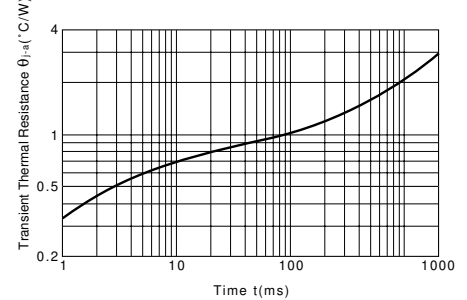

$f_T - I_E$ Characteristics (Typical)

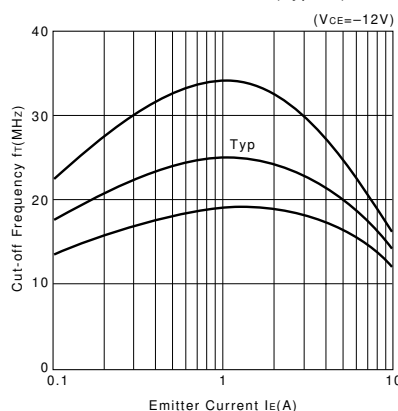

Safe Operating Area (Single Pulse)

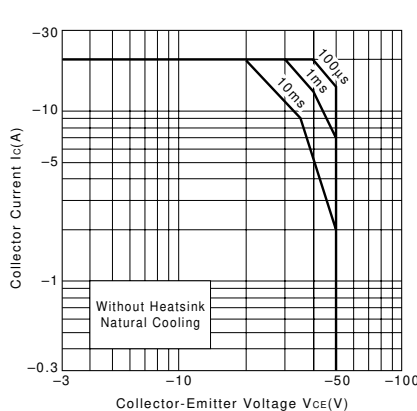

$P_C - T_a$ Derating

