



Chipsmall Limited consists of a professional team with an average of over 10 year of expertise in the distribution of electronic components. Based in Hongkong, we have already established firm and mutual-benefit business relationships with customers from,Europe,America and south Asia,supplying obsolete and hard-to-find components to meet their specific needs.

With the principle of “Quality Parts,Customers Priority,Honest Operation,and Considerate Service”,our business mainly focus on the distribution of electronic components. Line cards we deal with include Microchip,ALPS,ROHM,Xilinx,Pulse,ON,Everlight and Freescale. Main products comprise IC,Modules,Potentiometer,IC Socket,Relay,Connector.Our parts cover such applications as commercial,industrial, and automotives areas.

We are looking forward to setting up business relationship with you and hope to provide you with the best service and solution. Let us make a better world for our industry!



Contact us

Tel: +86-755-8981 8866 Fax: +86-755-8427 6832

Email & Skype: info@chipsmall.com Web: www.chipsmall.com

Address: A1208, Overseas Decoration Building, #122 Zhenhua RD., Futian, Shenzhen, China



2SA1909

Silicon PNP Epitaxial Planar Transistor (Complement to type 2SC5101)

Application : Audio and General Purpose

■ Absolute maximum ratings (Ta=25°C)

Symbol	Ratings	Unit
V _{CB0}	-140	V
V _{CE0}	-140	V
V _{EB0}	-6	V
I _C	-10	A
I _B	-4	A
P _C	80(T _C =25°C)	W
T _J	150	°C
T _{stg}	-55 to +150	°C

■ Electrical Characteristics (Ta=25°C)

Symbol	Conditions	Ratings	Unit
I _{CB0}	V _{CB} =-140V	-10max	μA
I _{EB0}	V _{EB} =-6V	-10max	μA
V _{(BR)CEO}	I _C =-50mA	-140min	V
h _{FE}	V _{CE} =-4V, I _C =-3A	50min*	
V _{CE(sat)}	I _C =-5A, I _B =-0.5A	-0.5max	V
f _T	V _{CE} =-12V, I _E =0.5A	20typ	MHz
COB	V _{CB} =-10V, f=1MHz	400typ	pF

*h_{FE} Rank O(50 to 100), P(70 to 140), Y(90 to 180)

■ Typical Switching Characteristics (Common Emitter)

V _{CC} (V)	R _L (Ω)	I _C (A)	V _{BB1} (V)	V _{BB2} (V)	I _{B1} (A)	I _{B2} (A)	t _{on} (μs)	t _{stg} (μs)	t _f (μs)
-60	12	-5	-10	5	-0.5	0.5	0.17typ	1.86typ	0.27typ

External Dimensions FM100(TO3PF)

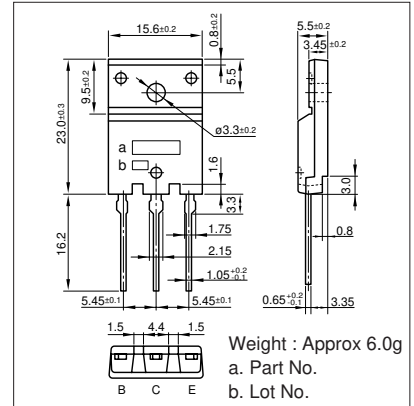

I_C-V_{CE} Characteristics (Typical)

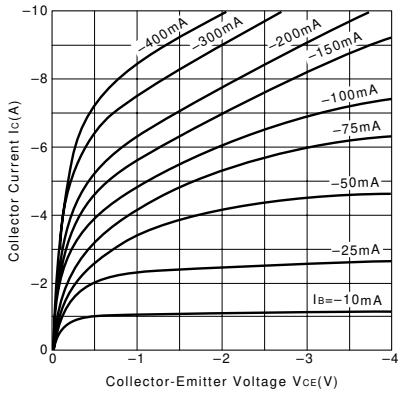

V_{CE(sat)}-I_B Characteristics (Typical)

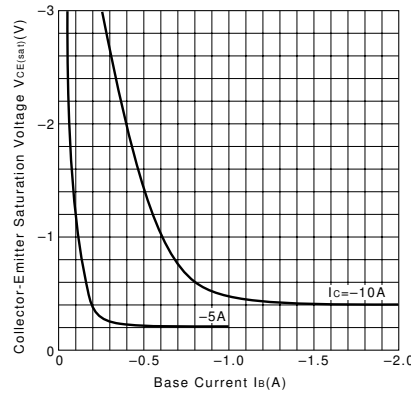

I_C-V_{BE} Temperature Characteristics (Typical)

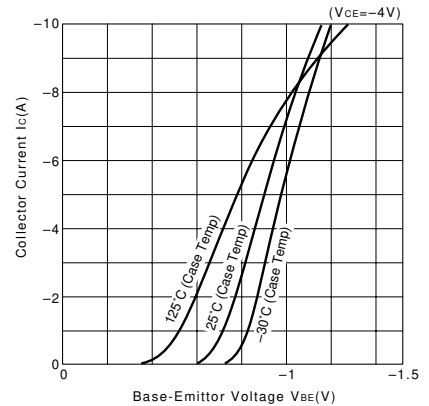

h_{FE}-I_C Characteristics (Typical)

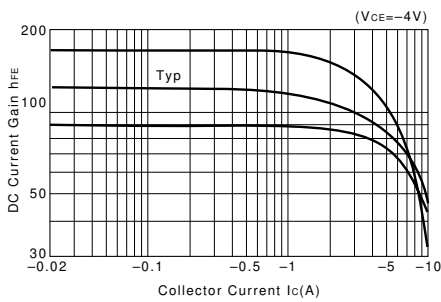

h_{FE}-I_C Temperature Characteristics (Typical)

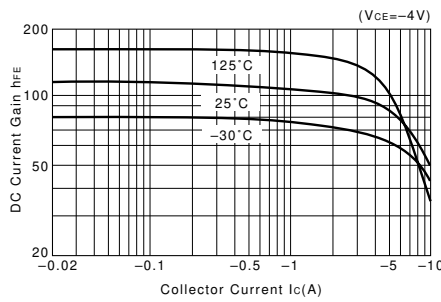

θ_{j-a}-t Characteristics

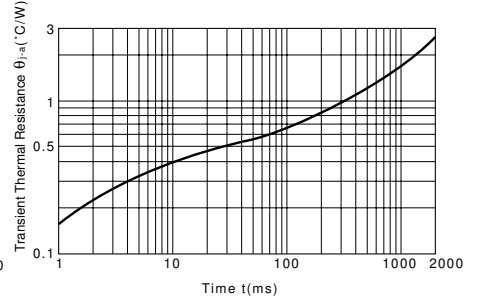

f_T-I_E Characteristics (Typical)

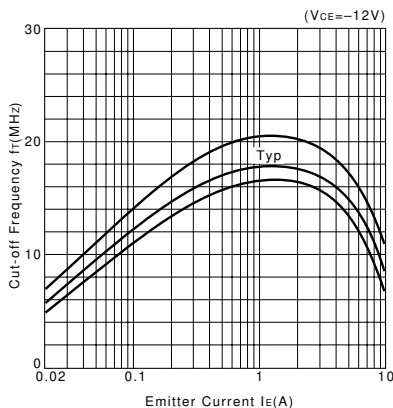

Safe Operating Area (Single Pulse)

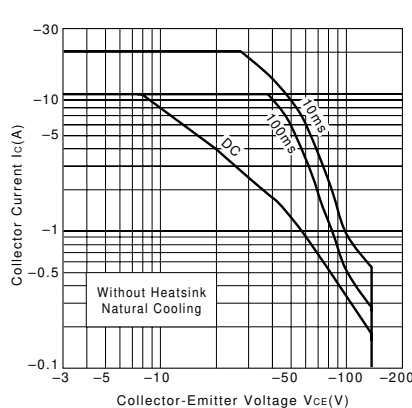

P_C-T_a Derating

