



Chipsmall Limited consists of a professional team with an average of over 10 year of expertise in the distribution of electronic components. Based in Hongkong, we have already established firm and mutual-benefit business relationships with customers from,Europe,America and south Asia,supplying obsolete and hard-to-find components to meet their specific needs.

With the principle of “Quality Parts,Customers Priority,Honest Operation,and Considerate Service”,our business mainly focus on the distribution of electronic components. Line cards we deal with include Microchip,ALPS,ROHM,Xilinx,Pulse,ON,Everlight and Freescale. Main products comprise IC,Modules,Potentiometer,IC Socket,Relay,Connector.Our parts cover such applications as commercial,industrial, and automotives areas.

We are looking forward to setting up business relationship with you and hope to provide you with the best service and solution. Let us make a better world for our industry!



Contact us

Tel: +86-755-8981 8866 Fax: +86-755-8427 6832

Email & Skype: info@chipsmall.com Web: www.chipsmall.com

Address: A1208, Overseas Decoration Building, #122 Zhenhua RD., Futian, Shenzhen, China



LAPT 2SC3519/3519A

Silicon NPN Epitaxial Planar Transistor (Complement to type 2SA1386/A)

Application : Audio and General Purpose

■ Absolute maximum ratings (Ta=25°C)

Symbol	Ratings		Unit
	2SC3519	2SC3519A	
V _{CB0}	160	180	V
V _{CE0}	160	180	V
V _{EB0}	5		V
I _C	15		A
I _B	4		A
P _C	130(T _C =25°C)		W
T _J	150		°C
T _{stg}	-55 to +150		°C

■ Electrical Characteristics (Ta=25°C)

Symbol	Conditions	Ratings		Unit
		2SC3519	2SC3519A	
I _{CB0}	V _{CB} =	160	180	μA
I _{EB0}	V _{EB} =5V	100max		μA
V _{(BR)CEO}	I _C =25mA	160min	180min	V
h _{FE}	V _{CE} =4V, I _C =5A	50min*		
V _{CE(sat)}	I _C =5A, I _B =0.5A	2.0max		V
f _T	V _{CE} =12V, I _E =-2A	50typ		MHz
C _{OB}	V _{CB} =10V, f=1MHz	250typ		pF

*h_{FE} Rank: \bar{O} (50 to 100), P(70 to 140), Y(90 to 180)

■ Typical Switching Characteristics (Common Emitter)

V _{CC} (V)	R _L (Ω)	I _C (A)	V _{BB1} (V)	V _{BB2} (V)	I _{B1} (A)	I _{B2} (A)	t _{on} (μs)	t _{stg} (μs)	t _f (μs)
40	4	10	10	-5	1	-1	0.2typ	1.3typ	0.45typ

External Dimensions MT-100(TO3P)

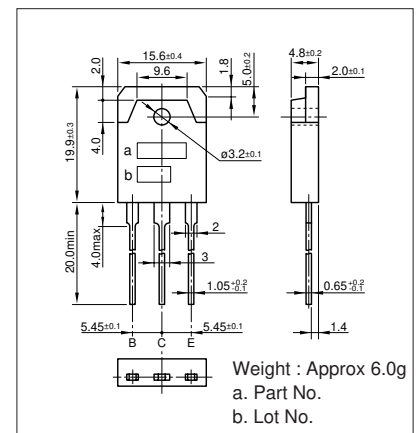

I_C-V_{CE} Characteristics (Typical)

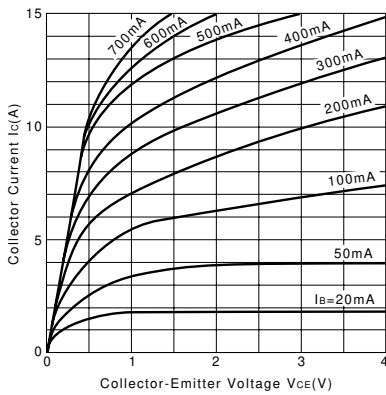

V_{CE(sat)}-I_B Characteristics (Typical)

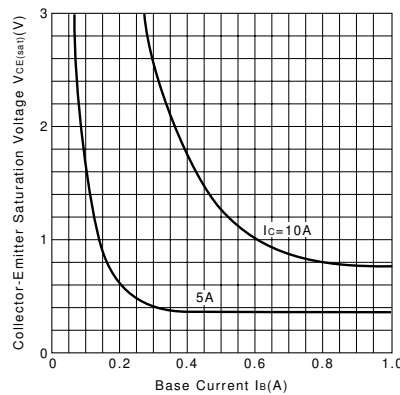

I_C-V_{BE} Temperature Characteristics (Typical)

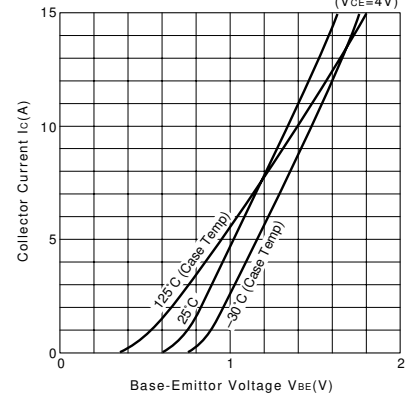

h_{FE}-I_C Characteristics (Typical)

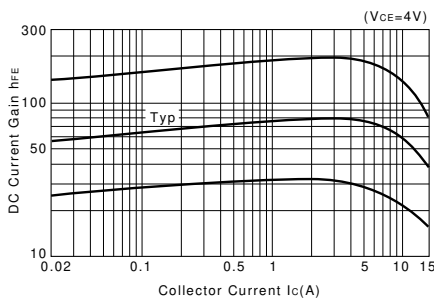

h_{FE}-I_C Temperature Characteristics (Typical)

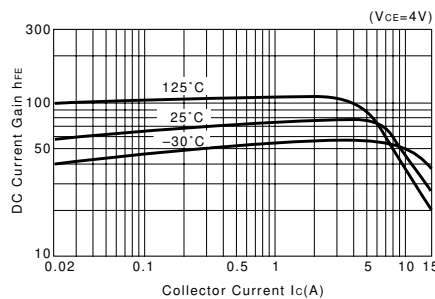

θ_{j-a}-t Characteristics

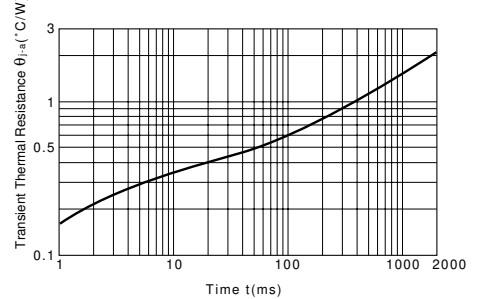

f_T-I_E Characteristics (Typical)

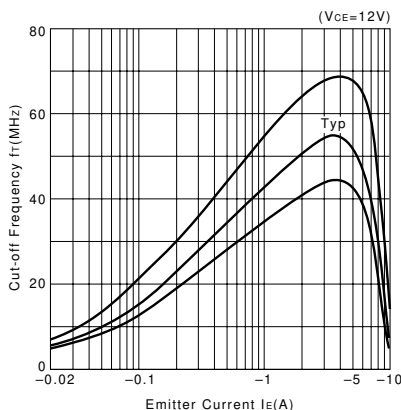

Safe Operating Area (Single Pulse)

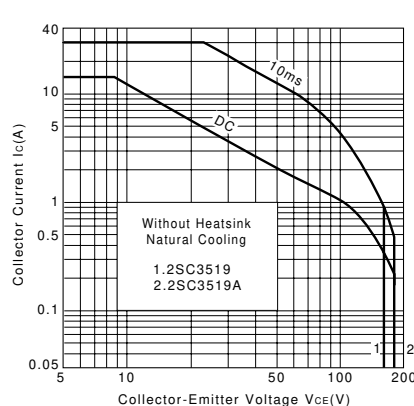

P_C-T_a Derating

