



Chipsmall Limited consists of a professional team with an average of over 10 year of expertise in the distribution of electronic components. Based in Hongkong, we have already established firm and mutual-benefit business relationships with customers from,Europe,America and south Asia,supplying obsolete and hard-to-find components to meet their specific needs.

With the principle of “Quality Parts,Customers Priority,Honest Operation,and Considerate Service”,our business mainly focus on the distribution of electronic components. Line cards we deal with include Microchip,ALPS,ROHM,Xilinx,Pulse,ON,Everlight and Freescale. Main products comprise IC,Modules,Potentiometer,IC Socket,Relay,Connector.Our parts cover such applications as commercial,industrial, and automotives areas.

We are looking forward to setting up business relationship with you and hope to provide you with the best service and solution. Let us make a better world for our industry!



Contact us

Tel: +86-755-8981 8866 Fax: +86-755-8427 6832

Email & Skype: info@chipsmall.com Web: www.chipsmall.com

Address: A1208, Overseas Decoration Building, #122 Zhenhua RD., Futian, Shenzhen, China



2SC3835

Silicon NPN Triple Diffused Planar Transistor (Switching Transistor)

Application : Humidifier, DC-DC Converter, and General Purpose

Absolute maximum ratings (Ta=25°C)

Symbol	Ratings	Unit
V _{CB0}	200	V
V _{CEO}	120	V
V _{EB0}	8	V
I _C	7(Pulse14)	A
I _B	3	A
P _C	70(Tc=25°C)	W
T _J	150	°C
T _{stg}	-55 to +150	°C

Electrical Characteristics (Ta=25°C)

Symbol	Conditions	Ratings	Unit
I _{CB0}	V _{CB} =200V	100max	μA
I _{EB0}	V _{EB} =8V	100max	μA
V _{(BR)CEO}	I _C =50mA	120min	V
h _{FE}	V _{CE} =4V, I _C =3A	70 to 220	
V _{CE(sat)}	I _C =3A, I _B =0.3A	0.5max	V
V _{BE(sat)}	I _C =3A, I _B =0.3A	1.2max	V
f _r	V _{CE} =12V, I _E =-0.5A	30typ	MHz
COB	V _{CB} =10V, f=1MHz	110typ	pF

Typical Switching Characteristics (Common Emitter)

V _{CC} (V)	R _L (Ω)	I _C (A)	V _{BB1} (V)	V _{BB2} (V)	I _{B1} (A)	I _{B2} (A)	t _{on} (μs)	t _{stg} (μs)	t _f (μs)
50	16.7	3	10	-5	0.3	-0.6	0.5max	3.0max	0.5max

External Dimensions MT-100(TO3P)

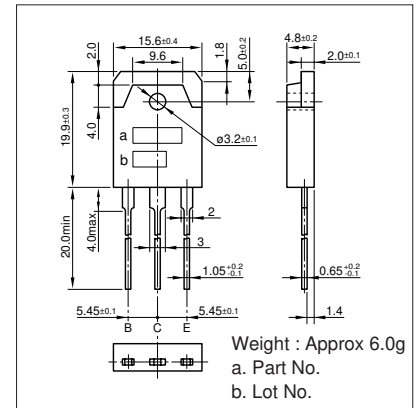

I_C-V_{CE} Characteristics (Typical)

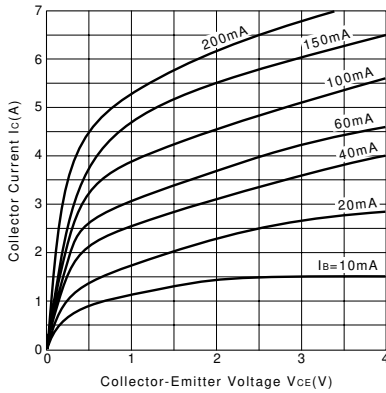

V_{CE(sat)}-I_B Characteristics (Typical)

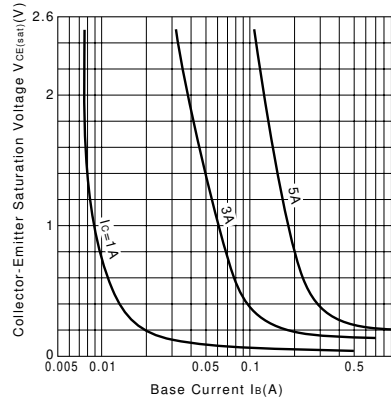

I_C-V_{BE} Temperature Characteristics (Typical)

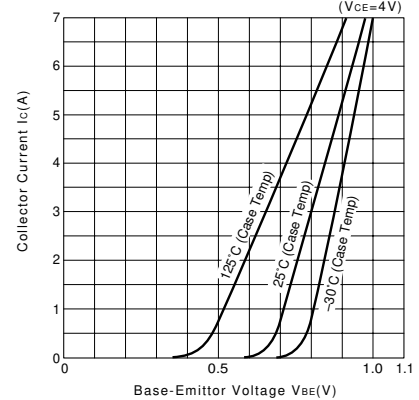

h_{FE}-I_C Characteristics (Typical)

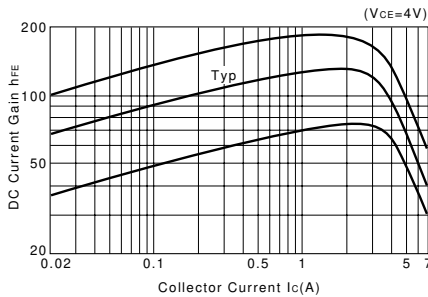

h_{FE}-I_C Temperature Characteristics (Typical)

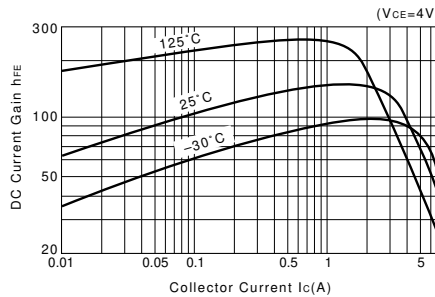

θ_{J-a}-t Characteristics

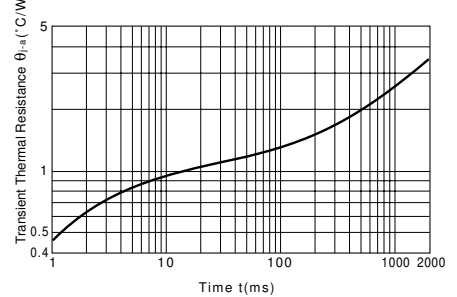

f_T-I_E Characteristics (Typical)

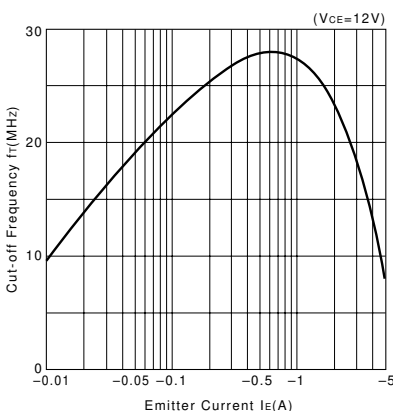

Safe Operating Area (Single Pulse)

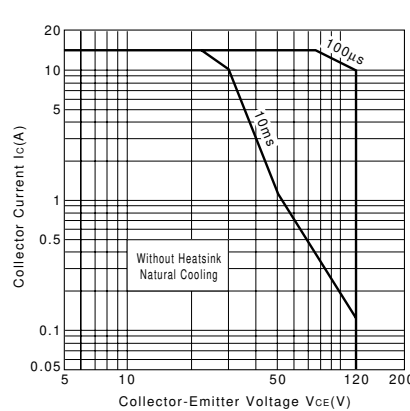

P_C-T_a Derating

