



Chipsmall Limited consists of a professional team with an average of over 10 year of expertise in the distribution of electronic components. Based in Hongkong, we have already established firm and mutual-benefit business relationships with customers from,Europe,America and south Asia,supplying obsolete and hard-to-find components to meet their specific needs.

With the principle of "Quality Parts,Customers Priority,Honest Operation,and Considerate Service",our business mainly focus on the distribution of electronic components. Line cards we deal with include Microchip,ALPS,ROHM,Xilinx,Pulse,ON,Everlight and Freescale. Main products comprise IC,Modules,Potentiometer,IC Socket,Relay,Connector.Our parts cover such applications as commercial,industrial, and automotives areas.

We are looking forward to setting up business relationship with you and hope to provide you with the best service and solution. Let us make a better world for our industry!



Contact us

Tel: +86-755-8981 8866 Fax: +86-755-8427 6832

Email & Skype: info@chipsmall.com Web: www.chipsmall.com

Address: A1208, Overseas Decoration Building, #122 Zhenhua RD., Futian, Shenzhen, China



2SC3851/3851A

Silicon NPN Epitaxial Planar Transistor (Complement to type 2SA1488/A)

Application : Audio and PPC High Voltage Power Supply, and General Purpose

■ Absolute maximum ratings (Ta=25°C)

Symbol	Ratings		Unit
	2SC3851	2SC3851A	
V _{CB0}	80	100	V
V _{CE0}	60	80	V
V _{EB0}	6		V
I _c	4		A
I _b	1		A
P _c	25(Tc=25°C)		W
T _j	150		°C
T _{stg}	-55 to +150		°C

■ Electrical Characteristics (Ta=25°C)

Symbol	Conditions	Ratings		Unit
		2SC3851	2SC3851A	
I _{cB0}	V _{CB} =	100max		μA
V _{CE0}	V _{EB} =6V	80	100	V
I _{EB0}	V _{EB} =6V	100max		μA
V _{(BR)CEO}	I _c =25mA	60min	80min	V
h _{FE}	V _{CE} =4V, I _c =1A	40 to 320		
V _{CE(sat)}	I _c =2A, I _b =0.2A	0.5max		V
f _T	V _{CE} =12V, I _E =-0.2A	15typ		MHz
C _{OB}	V _{CB} =10V, f=1MHz	60typ		pF

External Dimensions FM20(TO220F)

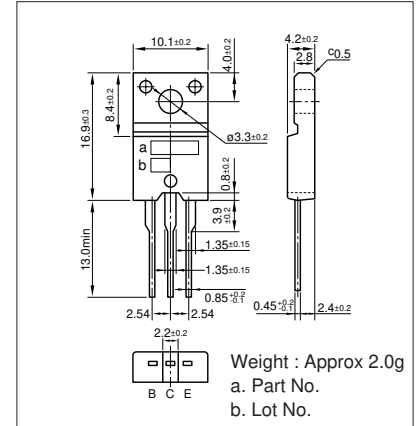

■ Typical Switching Characteristics (Common Emitter)

V _{CC} (V)	R _L (Ω)	I _c (A)	V _{BB1} (V)	V _{BB2} (V)	I _{B1} (mA)	I _{B2} (mA)	t _{on} (μs)	t _{stg} (μs)	t _f (μs)
12	6	2	10	-5	200	-200	0.2typ	1typ	0.3typ

I_c-V_{CE} Characteristics (Typical)

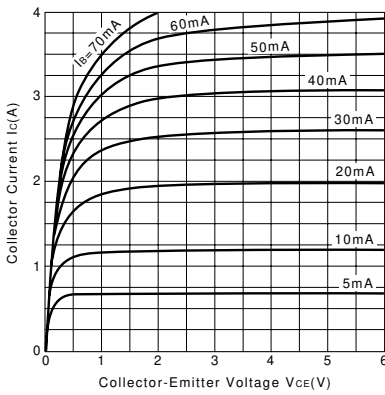

V_{CE(sat)}-I_B Characteristics (Typical)

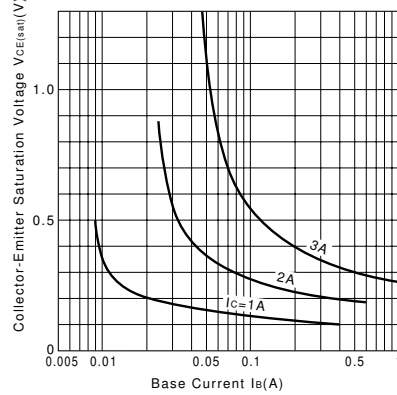

I_c-V_{BE} Temperature Characteristics (Typical)

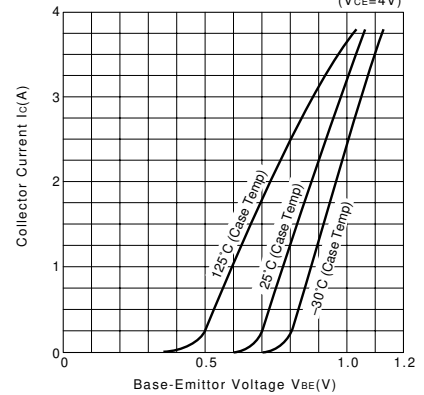

h_{FE}-I_c Characteristics (Typical)

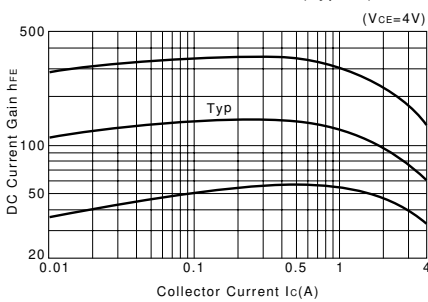

h_{FE}-I_c Temperature Characteristics (Typical)

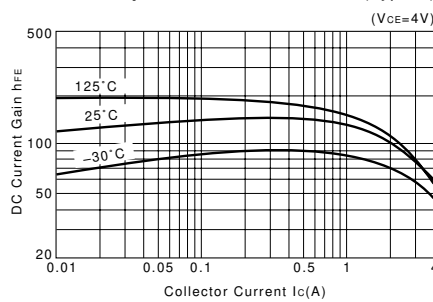

θ_{j-a-t} Characteristics

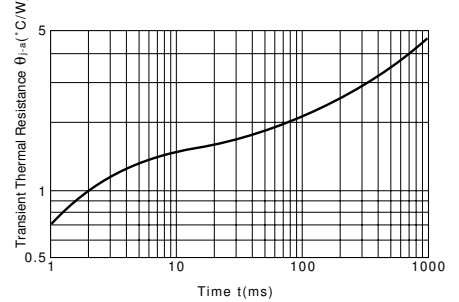

f_T-I_E Characteristics (Typical)

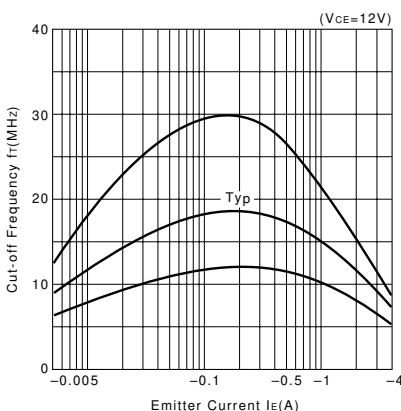

Safe Operating Area (Single Pulse)

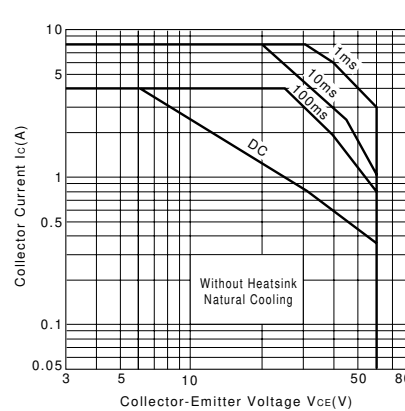

P_c-T_a Derating

