



Chipsmall Limited consists of a professional team with an average of over 10 year of expertise in the distribution of electronic components. Based in Hongkong, we have already established firm and mutual-benefit business relationships with customers from,Europe,America and south Asia,supplying obsolete and hard-to-find components to meet their specific needs.

With the principle of “Quality Parts,Customers Priority,Honest Operation,and Considerate Service”,our business mainly focus on the distribution of electronic components. Line cards we deal with include Microchip,ALPS,ROHM,Xilinx,Pulse,ON,Everlight and Freescale. Main products comprise IC,Modules,Potentiometer,IC Socket,Relay,Connector.Our parts cover such applications as commercial,industrial, and automotives areas.

We are looking forward to setting up business relationship with you and hope to provide you with the best service and solution. Let us make a better world for our industry!



Contact us

Tel: +86-755-8981 8866 Fax: +86-755-8427 6832

Email & Skype: info@chipsmall.com Web: www.chipsmall.com

Address: A1208, Overseas Decoration Building, #122 Zhenhua RD., Futian, Shenzhen, China





SILICON TRANSISTOR

NE68039 / 2SC4095 JEITA Part No.

MICROWAVE LOW NOISE AMPLIFIER NPN SILICON EPITAXIAL TRANSISTOR 4 PINS MINI MOLD

DESCRIPTION

The NE68039 / 2SC4095 is an NPN epitaxial silicon transistor designed for use in low-noise and small signal amplifiers from VHF band to UHF band. NE68039 / 2SC4095 features excellent power gain with very low-noise figures. NE68039 / 2SC4095 employs direct nitride passivated base surface process (DNP process) which is a proprietary new fabrication technique which provides excellent noise figures at high current values. This allows excellent associated gain and very wide dynamic range.

FEATURES

- NF = 1.8 dB TYP. @ f = 2.0 GHz, V_{CE} = 6 V, I_C = 5 mA
- |S_{21e}|² = 9.5 dB TYP. @ f = 2.0 GHz, V_{CE} = 6 V, I_C = 10 mA

ABSOLUTE MAXIMUM RATINGS (T_A = 25 °C)

Collector to Base Voltage	V _{CB0}	20	V
Collector to Emitter Voltage	V _{CEO}	10	V
Emitter to Base Voltage	V _{EB0}	1.5	V
Collector Current	I _C	35	mA
Total Power Dissipation	P _T	200	mW
Junction Temperature	T _j	150	°C
Storage Temperature	T _{stg}	-65 to +150	°C

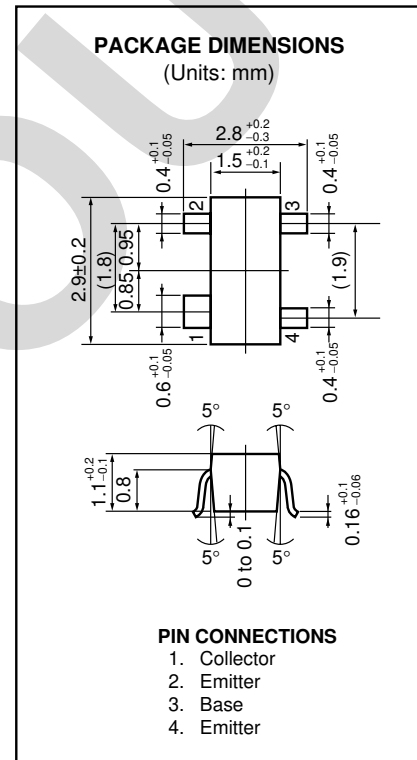

ELECTRICAL CHARACTERISTICS (T_A = 25 °C)

CHARACTERISTIC	SYMBOL	MIN.	TYP.	MAX.	UNIT	TEST CONDITIONS
Collector Cutoff Current	I _{CB0}			1.0	μA	V _{CB} = 10 V, I _E = 0
Emitter Cutoff Current	I _{EB0}			1.0	μA	V _{EB} = 1 V, I _C = 0
DC Current Gain	h _{FE}	50	100	250		V _{CE} = 6 V, I _C = 10 mA
Gain Bandwidth Product	f _T		10		GHz	V _{CE} = 6 V, I _C = 10 mA, f = 1.0 GHz
Feed-Back Capacitance	C _{re}		0.25	0.8	pF	V _{CB} = 10 V, I _E = 0, f = 1.0 MHz
Insertion Power Gain	S _{21e} ²	7.5	9.5		dB	V _{CE} = 6 V, I _C = 10 mA, f = 2.0 GHz
Maximum Available Gain	MAG		12		dB	V _{CE} = 6 V, I _C = 10 mA, f = 2.0 GHz
Noise Figure	NF		1.8	3.0	dB	V _{CE} = 6 V, I _C = 5 mA, f = 2.0 GHz

h_{FE} Classification

Class	R46/RDF *	R47/RDG *	R48/RDH *
Marking	R46	R47	R48
h _{FE}	50 to 100	80 to 160	125 to 250

ORDERING INFORMATION

Part Number	Order Number	Quantity
NE68039-T1 2SC4095-T1	NE68039-T1-A 2SC4095-T1-A	3 kpcs/Reel

* Old Specification / New Specification

TYPICAL CHARACTERISTICS (T_A = 25 °C)

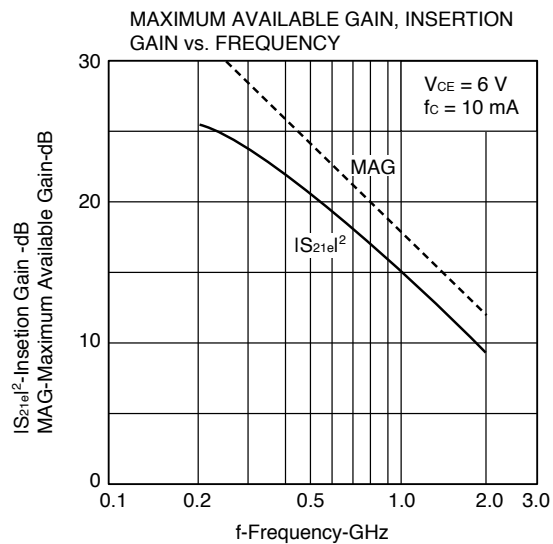
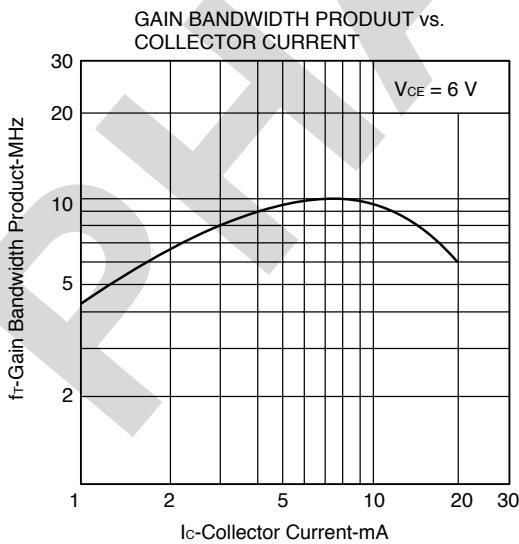
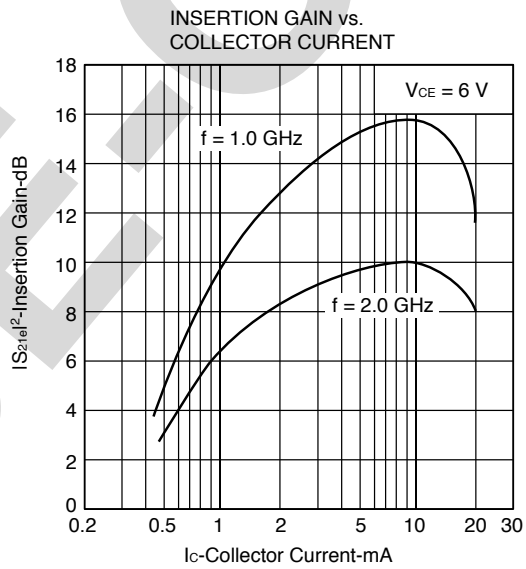
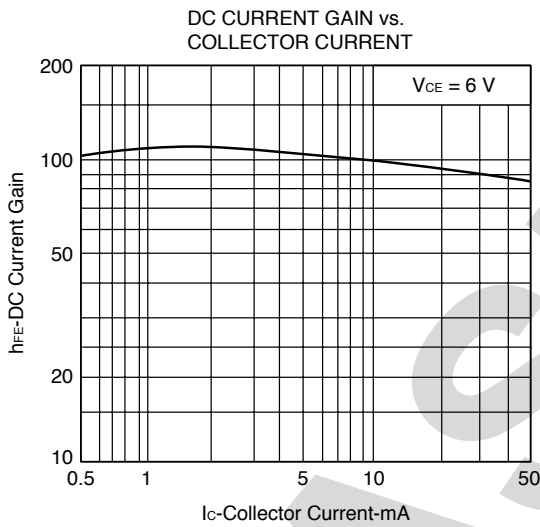
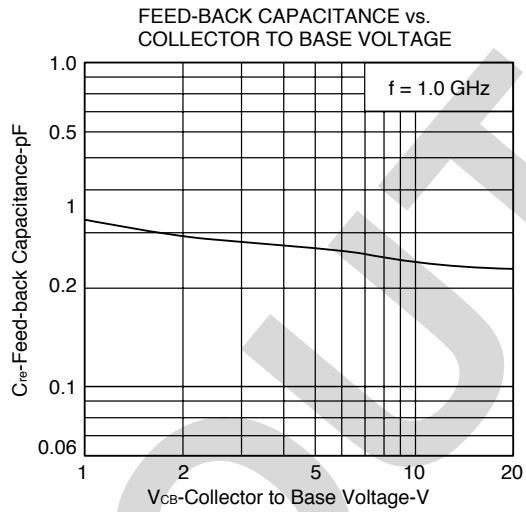
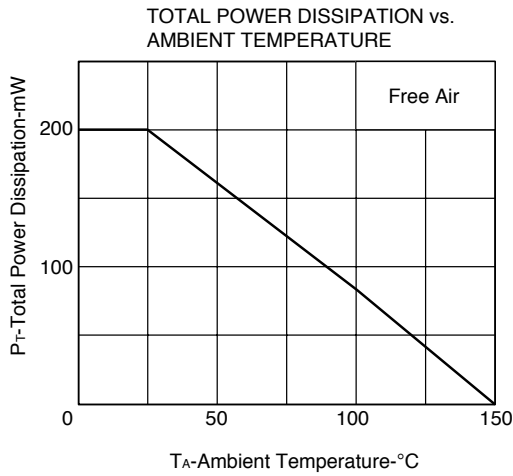

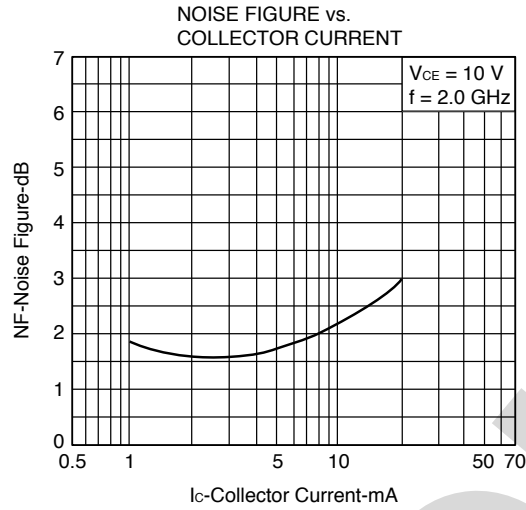

S-PARAMETER

V_{CE} = 6.0 V, I_C = 3.0 mA, Z_O = 50 Ω

f (MHz)	S ₁₁	∠ S ₁₁	S ₂₁	∠ S ₂₁	S ₁₂	∠ S ₁₂	S ₂₂	∠ S ₂₂
200	0.870	-24.2	9.193	155.6	0.031	53.6	0.946	-12.8
400	0.747	-44.6	7.780	136.6	0.040	66.2	0.876	-20.7
600	0.628	-59.8	7.058	122.1	0.064	54.7	0.816	-26.4
800	0.516	-75.1	5.675	109.4	0.066	56.0	0.743	-30.9
1000	0.400	-87.7	5.180	99.6	0.090	49.4	0.689	-33.0
1200	0.327	-103.4	4.269	89.8	0.084	47.9	0.654	-35.7
1400	0.262	-118.7	3.950	81.7	0.106	48.5	0.604	-37.7
1600	0.231	-135.5	3.406	74.0	0.105	42.1	0.581	-41.5
1800	0.205	-155.3	3.290	66.4	0.126	46.4	0.548	-43.9
2000	0.196	-170.6	2.867	60.8	0.124	40.9	0.529	-47.1

V_{CE} 6.0 V, I_C = 10.0 mA, Z_O = 50 Ω

f (MHz)	S ₁₁	∠ S ₁₁	S ₂₁	∠ S ₂₁	S ₁₂	∠ S ₁₂	S ₂₂	∠ S ₂₂
200	0.671	-43.5	18.685	137.9	0.023	52.1	0.832	-19.0
400	0.458	-68.7	12.702	115.2	0.029	62.2	0.710	-23.9
600	0.319	-83.7	9.895	102.8	0.046	54.4	0.649	-26.0
800	.0239	-101.9	7.275	92.3	0.049	63.1	0.600	-27.5
1000	0.172	-119.3	6.261	85.1	0.067	58.6	0.578	-28.4
1200	0.149	-141.4	5.038	77.4	0.070	57.9	0.559	-30.3
1400	0.131	-163.0	4.597	71.0	0.088	56.1	0.527	-32.5
1600	0.132	179.6	3.927	64.8	0.094	54.0	0.514	-35.7
1800	0.150	160.0	3.743	58.8	0.113	55.3	0.494	-38.1
2000	0.163	150.1	3.233	54.5	0.115	50.0	0.478	-41.6

S-PARAMETER

S_{11e}, S_{22e}-FREQUENCY CONDITION V_{CE} = 6 V, I_c = 10/3 mA, freq. = 0.2 to 2 GHz (Step 200 MHz)

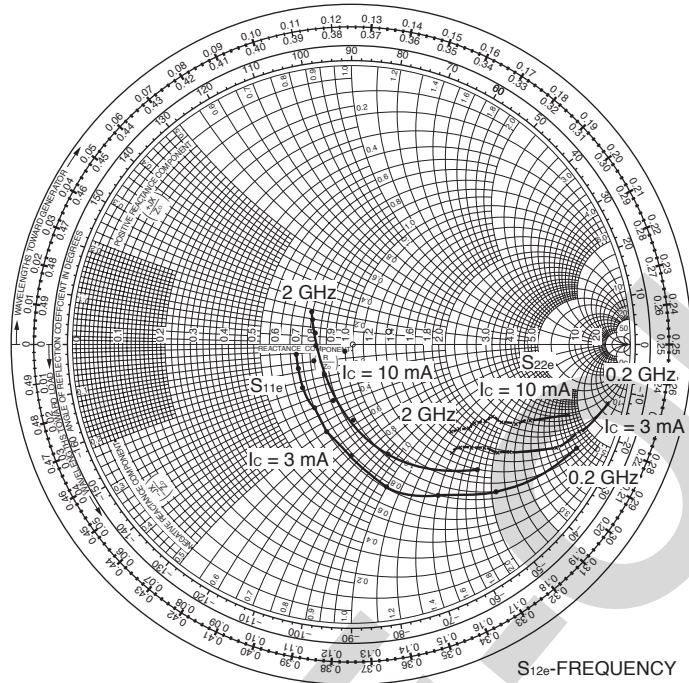

S_{21e}-FREQUENCY

CONDITION V_{CE} = 6 V
I_c = 10/3 mA
freq. = 0.2 to 2 GHz (Step 200 MHz)

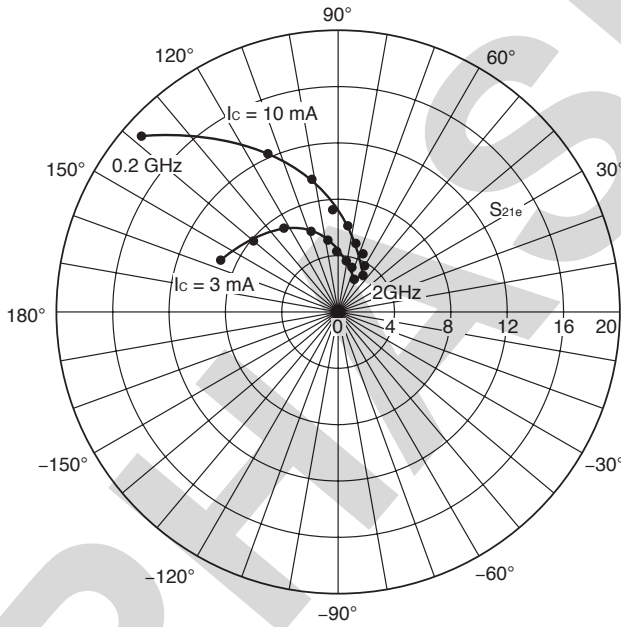

S_{12e}-FREQUENCY

CONDITION V_{CE} = 6 V
I_c = 10/3 mA
freq. = 0.2 to 2 GHz (Step 200 MHz)

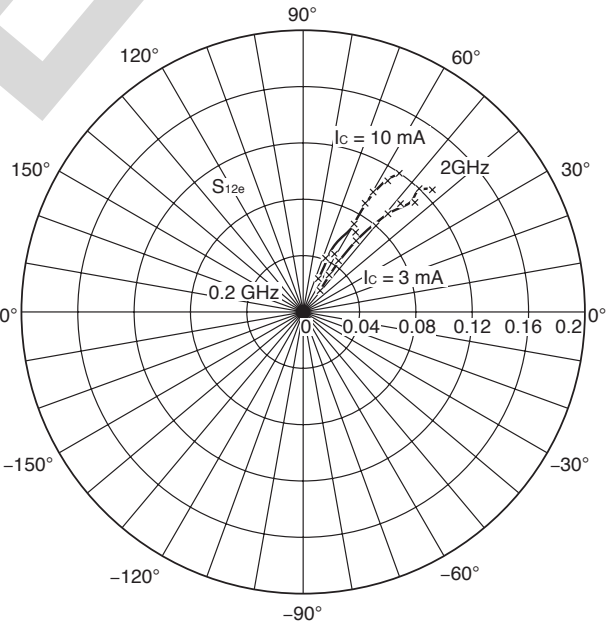

RECOMMENDED SOLDERING CONDITIONS

The following conditions (see table below) must be met then soldering this product. Please consult with our sales offices in case other soldering process is used, or in case soldering is done under different contions.

TYPES OF SURFACE MOUNT DEVICE

For more details, refer to our document "SMT MANUAL" (IEI-1207).

NE68039 / 2SC4095

Soldering process	Soldering conditions	Symbol
Infrared ray reflow	Peak package's surface temperature: 230 °C or below, Reflow time: 30 seconds or below (210 °C or higher), Number of reflow process: 1, Exposure limit*: None	IR30-00-1
VPS	Peak package's surface temperature: 215 °C or below, Reflow time: 40 seconds or below (200 °C or higher), Number of reflow process: 1, Exposure limit*: None	VP15-00-1
Wave soldering	Solder temperature: 260 °C or below, Flow time: 10 seconds or below, Number of reflow process: 1, Exposure limit*: None	WS60-00-1
Partial heating method	Terminal temperature: 300 °C or below, Flow time: 3 seconds or below, Exposure limit*: None	○

*: Exposure limit before soldering after dry-pack package is opened.

Storage conditions: 25 °C and relative humidity at 65 % or less.

Note: Do not apply more than a single process at once, except for "Partial heating method".

NOTICE

1. Descriptions of circuits, software and other related information in this document are provided only to illustrate the operation of semiconductor products and application examples. You are fully responsible for the incorporation of these circuits, software, and information in the design of your equipment. California Eastern Laboratories and Renesas Electronics assumes no responsibility for any losses incurred by you or third parties arising from the use of these circuits, software, or information.
2. California Eastern Laboratories has used reasonable care in preparing the information included in this document, but California Eastern Laboratories does not warrant that such information is error free. California Eastern Laboratories and Renesas Electronics assumes no liability whatsoever for any damages incurred by you resulting from errors in or omissions from the information included herein.
3. California Eastern Laboratories and Renesas Electronics do not assume any liability for infringement of patents, copyrights, or other intellectual property rights of third parties by or arising from the use of Renesas Electronics products or technical information described in this document. No license, express, implied or otherwise, is granted hereby under any patents, copyrights or other intellectual property rights of California Eastern Laboratories or Renesas Electronics or others.
4. You should not alter, modify, copy, or otherwise misappropriate any Renesas Electronics product, whether in whole or in part. California Eastern Laboratories and Renesas Electronics assume no responsibility for any losses incurred by you or third parties arising from such alteration, modification, copy or otherwise misappropriation of Renesas Electronics product.
5. Renesas Electronics products are classified according to the following two quality grades: "Standard" and "High Quality". The recommended applications for each Renesas Electronics product depends on the product's quality grade, as indicated below. "Standard": Computers; office equipment; communications equipment; test and measurement equipment; audio and visual equipment; home electronic appliances; machine tools; personal electronic equipment; and industrial robots etc. "High Quality": Transportation equipment (automobiles, trains, ships, etc.); traffic control systems; anti-disaster systems; anti-crime systems; and safety equipment etc. Renesas Electronics products are neither intended nor authorized for use in products or systems that may pose a direct threat to human life or bodily injury (artificial life support devices or systems, surgical implantations etc.), or may cause serious property damages (nuclear reactor control systems, military equipment etc.). You must check the quality grade of each Renesas Electronics product before using it in a particular application. You may not use any Renesas Electronics product for any application for which it is not intended. California Eastern Laboratories and Renesas Electronics shall not be in any way liable for any damages or losses incurred by you or third parties arising from the use of any Renesas Electronics product for which the product is not intended by California Eastern Laboratories or Renesas Electronics.
6. You should use the Renesas Electronics products described in this document within the range specified by California Eastern Laboratories, especially with respect to the maximum rating, operating supply voltage range, movement power voltage range, heat radiation characteristics, installation and other product characteristics. California Eastern Laboratories shall have no liability for malfunctions or damages arising out of the use of Renesas Electronics products beyond such specified ranges.
7. Although Renesas Electronics endeavors to improve the quality and reliability of its products, semiconductor products have specific characteristics such as the occurrence of failure at a certain rate and malfunctions under certain use conditions. Further, Renesas Electronics products are not subject to radiation resistance design. Please be sure to implement safety measures to guard them against the possibility of physical injury, and injury or damage caused by fire in the event of the failure of a Renesas Electronics product, such as safety design for hardware and software including but not limited to redundancy, fire control and malfunction prevention, appropriate treatment for aging degradation or any other appropriate measures. Because the evaluation of microcomputer software alone is very difficult, please evaluate the safety of the final products or systems manufactured by you.
8. Please contact a California Eastern Laboratories sales office for details as to environmental matters such as the environmental compatibility of each Renesas Electronics product. Please use Renesas Electronics products in compliance with all applicable laws and regulations that regulate the inclusion or use of controlled substances, including without limitation, the EU RoHS Directive. California Eastern Laboratories and Renesas Electronics assume no liability for damages or losses occurring as a result of your noncompliance with applicable laws and regulations.
9. Renesas Electronics products and technology may not be used for or incorporated into any products or systems whose manufacture, use, or sale is prohibited under any applicable domestic or foreign laws or regulations. You should not use Renesas Electronics products or technology described in this document for any purpose relating to military applications or use by the military, including but not limited to the development of weapons of mass destruction. When exporting the Renesas Electronics products or technology described in this document, you should comply with the applicable export control laws and regulations and follow the procedures required by such laws and regulations.
10. It is the responsibility of the buyer or distributor of California Eastern Laboratories, who distributes, disposes of, or otherwise places the Renesas Electronics product with a third party, to notify such third party in advance of the contents and conditions set forth in this document, California Eastern Laboratories and Renesas Electronics assume no responsibility for any losses incurred by you or third parties as a result of unauthorized use of Renesas Electronics products.
11. This document may not be reproduced or duplicated in any form, in whole or in part, without prior written consent of California Eastern Laboratories.
12. Please contact a California Eastern Laboratories sales office if you have any questions regarding the information contained in this document or Renesas Electronics products, or if you have any other inquiries.

NOTE 1: "Renesas Electronics" as used in this document means Renesas Electronics Corporation and also includes its majority-owned subsidiaries.

NOTE 2: "Renesas Electronics product(s)" means any product developed or manufactured by or for Renesas Electronics.

NOTE 3: Products and product information are subject to change without notice.

CEL Headquarters • 4590 Patrick Henry Drive, Santa Clara, CA 95054 • Phone (408) 919-2500 • www.cel.com

For a complete list of sales offices, representatives and distributors,
Please visit our website: www.cel.com/contactus