

Chipsmall Limited consists of a professional team with an average of over 10 year of expertise in the distribution of electronic components. Based in Hongkong, we have already established firm and mutual-benefit business relationships with customers from,Europe,America and south Asia,supplying obsolete and hard-to-find components to meet their specific needs.

With the principle of “Quality Parts,Customers Priority,Honest Operation,and Considerate Service”,our business mainly focus on the distribution of electronic components. Line cards we deal with include Microchip,ALPS,ROHM,Xilinx,Pulse,ON,Everlight and Freescale. Main products comprise IC,Modules,Potentiometer,IC Socket,Relay,Connector.Our parts cover such applications as commercial,industrial, and automotives areas.

We are looking forward to setting up business relationship with you and hope to provide you with the best service and solution. Let us make a better world for our industry!



Contact us

Tel: +86-755-8981 8866 Fax: +86-755-8427 6832

Email & Skype: info@chipsmall.com Web: www.chipsmall.com

Address: A1208, Overseas Decoration Building, #122 Zhenhua RD., Futian, Shenzhen, China

2SC4301

Silicon NPN Triple Diffused Planar Transistor (High Voltage Switching Transistor) **Application :** Switching Regulator, Lighting Inverter and General Purpose

Absolute maximum ratings (Ta=25°C)

Symbol	Ratings	Unit
VcBO	900	V
VcEO	800	V
VEBO	7	V
Ic	7(Pulse)14	A
IB	3.5	A
Pc	80(Tc=25°C)	W
Tj	150	°C
Tstg	-55 to +150	°C

Electrical Characteristics (Ta=25°C)

Symbol	Conditions	Ratings	Unit
IcBO	VcB=800V	100max	μA
IEBO	VEB=7V	100max	μA
V(BR)CEO	Ic=10mA	800min	V
hFE	VCE=4V, Ic=3A	10 to 30	
VCE(sat)	Ic=3A, IB=0.6A	0.5max	V
VBE(sat)	Ic=3A, IB=0.6A	1.2max	V
fr	VCE=12V, IE=-1A	6typ	MHZ
COB	VcB=10V, f=1MHZ	105typ	pF

External Dimensions FM100(TO3PF)

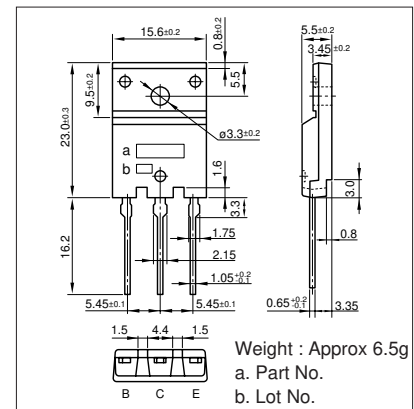

Typical Switching Characteristics (Common Emitter)

VCC (V)	RL (Ω)	Ic (A)	VBB1 (V)	VBB2 (V)	IB1 (A)	IB2 (A)	ton (μs)	tstg (μs)	tf (μs)
250	83	3	10	-5	0.45	-1.5	1max	5max	1max

Ic-VCE Characteristics (Typical)

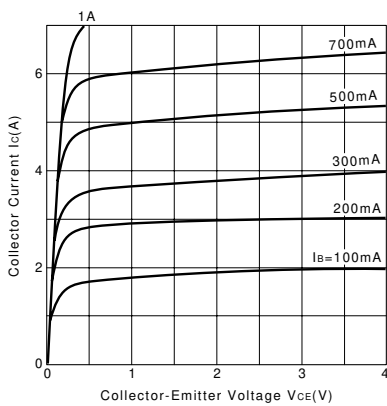

VCE(sat), VBE(sat)-Ic Temperature Characteristics (Typical)

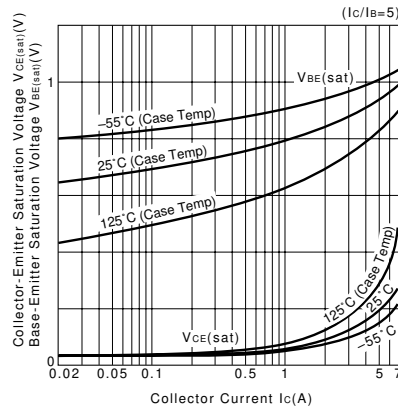

Ic-VBE Temperature Characteristics (Typical)

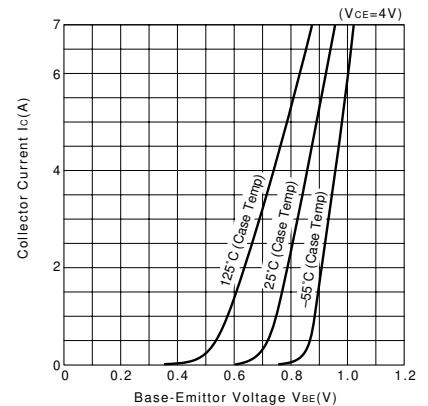

hFE-Ic Characteristics (Typical)

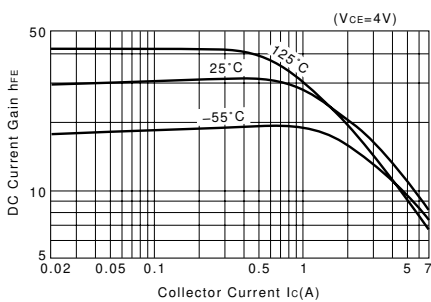

ton, tstg, tr-Ic Characteristics (Typical)

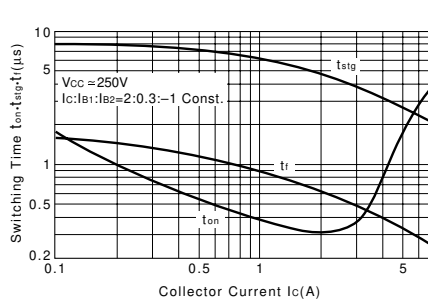

θj-a-t Characteristics

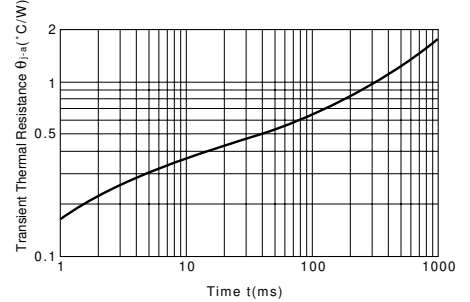

Safe Operating Area (Single Pulse)

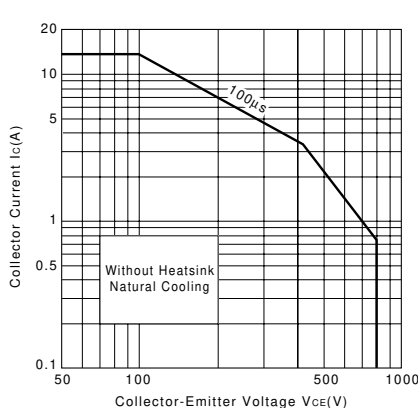

Reverse Bias Safe Operating Area

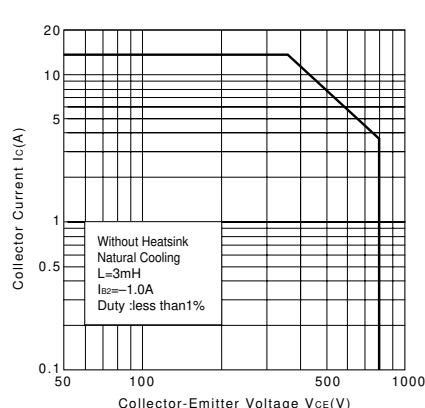

Pc-Ta Derating

