



Chipsmall Limited consists of a professional team with an average of over 10 year of expertise in the distribution of electronic components. Based in Hongkong, we have already established firm and mutual-benefit business relationships with customers from,Europe,America and south Asia,supplying obsolete and hard-to-find components to meet their specific needs.

With the principle of “Quality Parts,Customers Priority,Honest Operation,and Considerate Service”,our business mainly focus on the distribution of electronic components. Line cards we deal with include Microchip,ALPS,ROHM,Xilinx,Pulse,ON,Everlight and Freescale. Main products comprise IC,Modules,Potentiometer,IC Socket,Relay,Connector.Our parts cover such applications as commercial,industrial, and automotives areas.

We are looking forward to setting up business relationship with you and hope to provide you with the best service and solution. Let us make a better world for our industry!



Contact us

Tel: +86-755-8981 8866 Fax: +86-755-8427 6832

Email & Skype: info@chipsmall.com Web: www.chipsmall.com

Address: A1208, Overseas Decoration Building, #122 Zhenhua RD., Futian, Shenzhen, China



2SC5100

Silicon NPN Triple Diffused Planar Transistor (Complement to type 2SA1908)

Application : Audio and General Purpose

Absolute maximum ratings (Ta=25°C)

Symbol	Ratings	Unit
Vcbo	160	V
Vceo	120	V
Vebo	6	V
Ic	8	A
Ib	3	A
Pc	75(Tc=25°C)	W
Tj	150	°C
Tstg	-55 to +150	°C

Electrical Characteristics (Ta=25°C)

Symbol	Conditions	Ratings	Unit
Icbo	VcB=160V	10max	μA
Iebo	VEB=6V	10max	μA
V(BR)CEO	Ic=50mA	120min	V
hFE	VCE=4V, Ic=3A	50min*	
VCE(sat)	Ic=3A, Ib=0.3A	0.5max	V
fr	VCE=12V, IE=-0.5A	20typ	MHz
COB	VcB=10V, f=1MHz	200typ	pF

*hFE Rank O(50 to 100), P(70 to 140), Y(90 to 180)

Typical Switching Characteristics (Common Emitter)

Vcc (V)	RL (Ω)	Ic (A)	VBB1 (V)	VBB2 (V)	Ib1 (A)	Ib2 (A)	ton (μs)	tstg (μs)	tf (μs)
40	10	4	10	-5	0.4	-0.4	0.13typ	3.50typ	0.32typ

External Dimensions FM100(TO3PF)

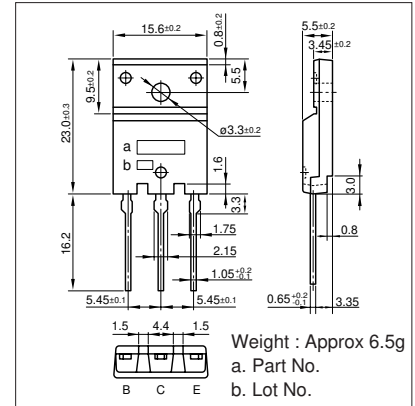

Ic-VCE Characteristics (Typical)

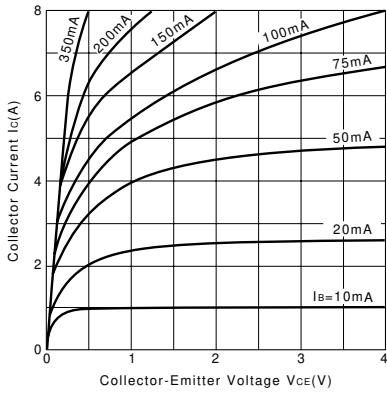

VCE(sat)-Ib Characteristics (Typical)

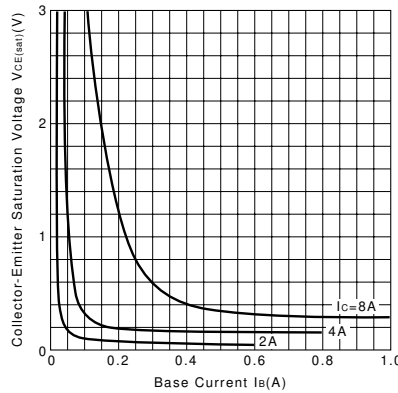

Ic-VBE Temperature Characteristics (Typical)

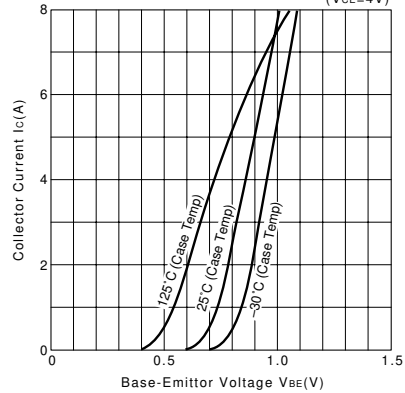

hFE-Ic Characteristics (Typical)

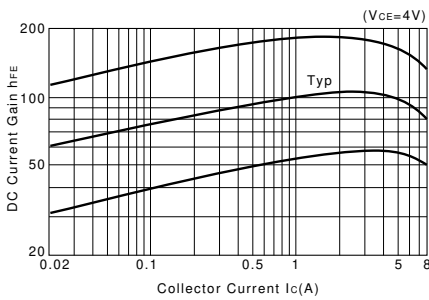

hFE-Ic Temperature Characteristics (Typical)

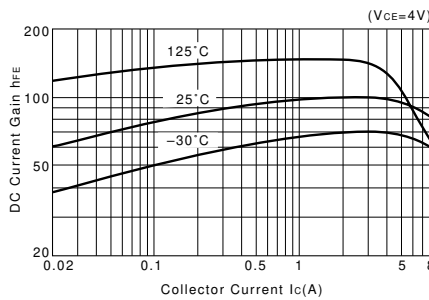

θj-a-t Characteristics

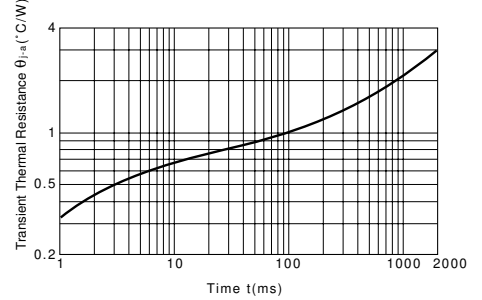

fr-Ie Characteristics (Typical)

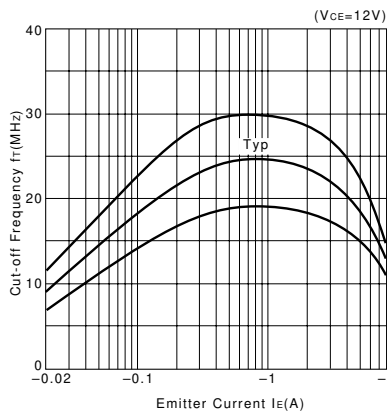

Safe Operating Area (Single Pulse)

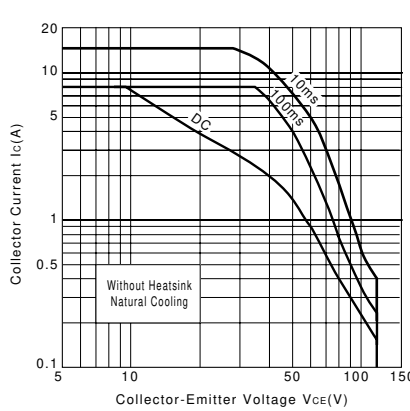

Pc-Ta Derating

