



Chipsmall Limited consists of a professional team with an average of over 10 year of expertise in the distribution of electronic components. Based in Hongkong, we have already established firm and mutual-benefit business relationships with customers from,Europe,America and south Asia,supplying obsolete and hard-to-find components to meet their specific needs.

With the principle of "Quality Parts,Customers Priority,Honest Operation,and Considerate Service",our business mainly focus on the distribution of electronic components. Line cards we deal with include Microchip,ALPS,ROHM,Xilinx,Pulse,ON,Everlight and Freescale. Main products comprise IC,Modules,Potentiometer,IC Socket,Relay,Connector.Our parts cover such applications as commercial,industrial, and automotives areas.

We are looking forward to setting up business relationship with you and hope to provide you with the best service and solution. Let us make a better world for our industry!



Contact us

Tel: +86-755-8981 8866 Fax: +86-755-8427 6832

Email & Skype: info@chipsmall.com Web: www.chipsmall.com

Address: A1208, Overseas Decoration Building, #122 Zhenhua RD., Futian, Shenzhen, China



Darlington 2SD2401

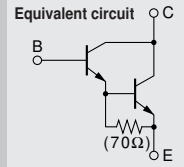

Silicon NPN Triple Diffused Planar Transistor (Complement to type 2SB1570)

Application : Audio, Series Regulator and General Purpose

Absolute maximum ratings (Ta=25°C)

Symbol	Ratings	Unit
V _{CB0}	160	V
V _{CE0}	150	V
V _{EB0}	5	V
I _C	12	A
I _B	1	A
P _C	150(T _C =25°C)	W
T _J	150	°C
T _{stg}	-55 to +150	°C

Electrical Characteristics (Ta=25°C)

Symbol	Conditions	Ratings	Unit
I _{CB0}	V _{CB} =160V	100max	μA
I _{EB0}	V _{EB} =5V	100max	μA
V _{(BR)CEO}	I _C =30mA	150min	V
h _{FE}	V _{CE} =4V, I _C =7A	5000min*	
V _{CE(sat)}	I _C =7A, I _B =7mA	2.5max	V
V _{BE(sat)}	I _C =7A, I _B =7mA	3.0max	V
f _T	V _{CE} =12V, I _E =-2A	55typ	MHz
C _{OB}	V _{CB} =10V, f=1MHz	95typ	pF

*h_{FE} Rank \bar{O} (5000 to 12000), P(6500 to 20000), Y(15000 to 30000)

Typical Switching Characteristics (Common Emitter)

V _{CC} (V)	R _L (Ω)	I _C (A)	V _{BB1} (V)	V _{BB2} (V)	I _{B1} (mA)	I _{B2} (mA)	t _{on} (μs)	t _{stg} (μs)	t _f (μs)
70	10	7	10	-5	7	-7	0.5typ	10.0typ	1.1typ

External Dimensions MT-200

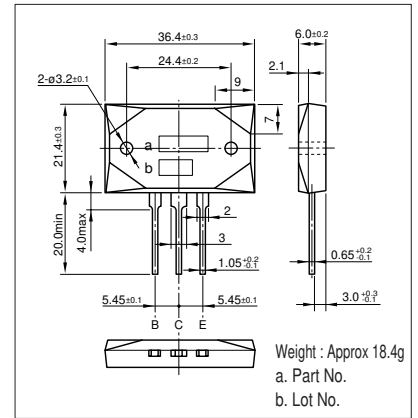

I_C-V_{CE} Characteristics (Typical)

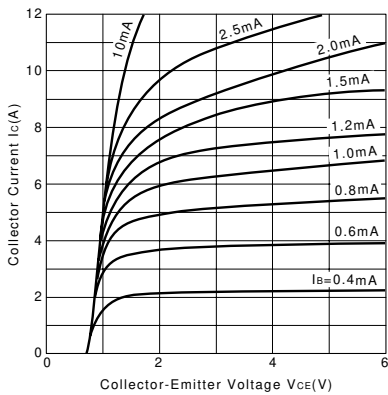

V_{CE(sat)}-I_B Characteristics (Typical)

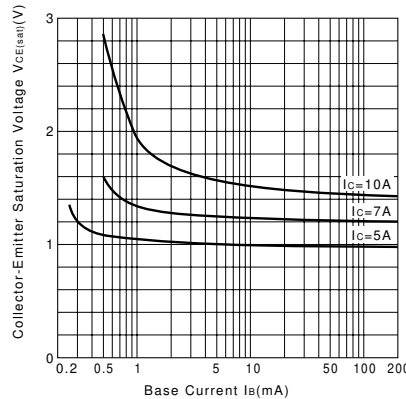

I_C-V_{BE} Temperature Characteristics (Typical)

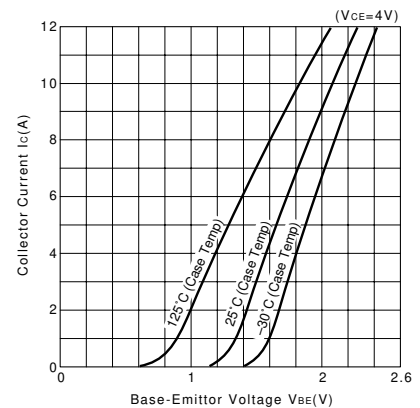

h_{FE}-I_C Characteristics (Typical)

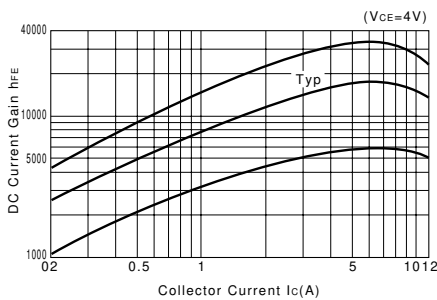

h_{FE}-I_C Temperature Characteristics (Typical)

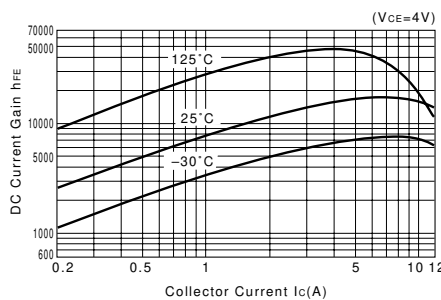

θ_{j-a}-t Characteristics

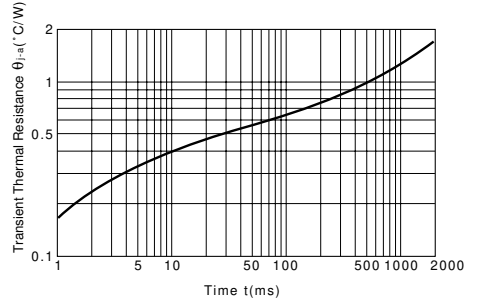

f_T-I_E Characteristics (Typical)

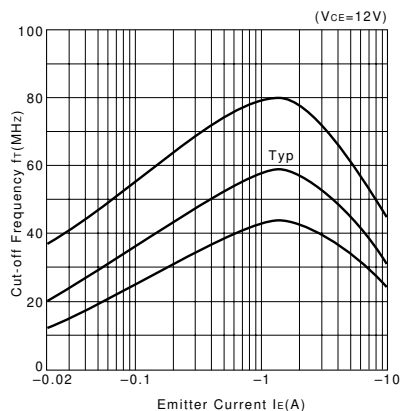

Safe Operating Area (Single Pulse)

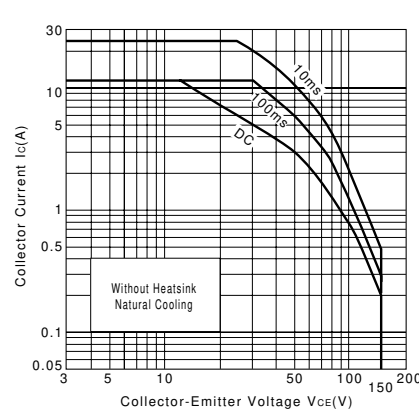

P_C-T_a Derating

