



Chipsmall Limited consists of a professional team with an average of over 10 year of expertise in the distribution of electronic components. Based in Hongkong, we have already established firm and mutual-benefit business relationships with customers from,Europe,America and south Asia,supplying obsolete and hard-to-find components to meet their specific needs.

With the principle of “Quality Parts,Customers Priority,Honest Operation,and Considerate Service”,our business mainly focus on the distribution of electronic components. Line cards we deal with include Microchip,ALPS,ROHM,Xilinx,Pulse,ON,Everlight and Freescale. Main products comprise IC,Modules,Potentiometer,IC Socket,Relay,Connector.Our parts cover such applications as commercial,industrial, and automotives areas.

We are looking forward to setting up business relationship with you and hope to provide you with the best service and solution. Let us make a better world for our industry!



Contact us

Tel: +86-755-8981 8866 Fax: +86-755-8427 6832

Email & Skype: info@chipsmall.com Web: www.chipsmall.com

Address: A1208, Overseas Decoration Building, #122 Zhenhua RD., Futian, Shenzhen, China



THESE DRAWINGS ARE THE PROPERTY OF QUALTEK ELECTRONICS AND NOT TO BE REPRODUCED FOR OR COMMUNICATED TO A THIRD PARTY WITHOUT THE EXPRESS WRITTEN PERMISSION OF AN OFFICER OF QUALTEK ELECTRONICS.

REVISION			
REV.	DESCRIPTION	DATE	APPROVED

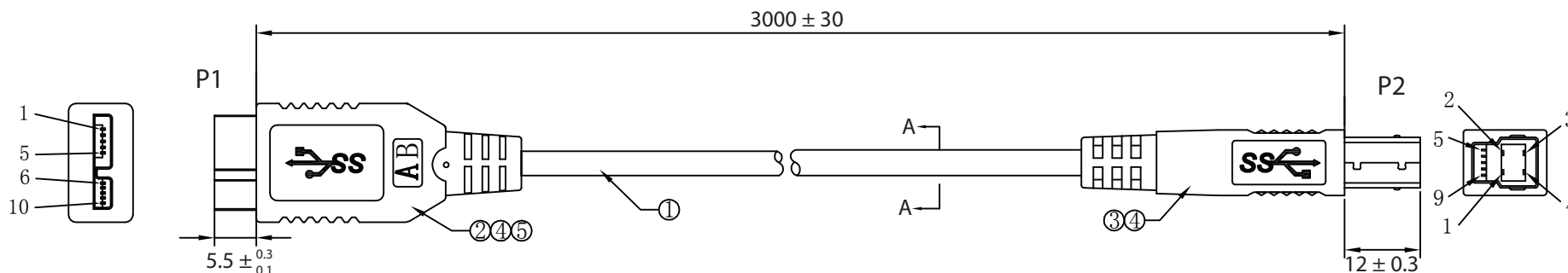

WIRING:

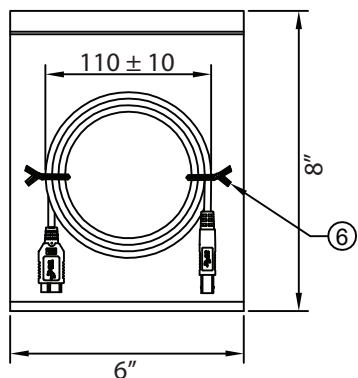

P1	COLOR	P2
1	RED	1
2	WHITE	2
3	GREEN	3
4	BLACK	4
5	BLUE	8
6	YELLOW	9
7	DRAIN WIRE	7
8	PURPLE	5
9	ORANGE	6
10	BRAID	SHIELD

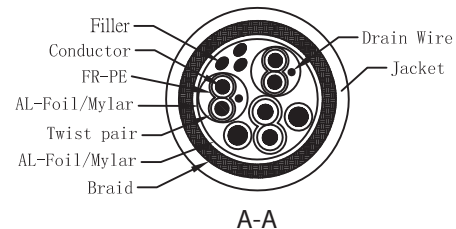

CONTROLLED

No.	PARTS NAME	SPECIFICATION STANDARD	QTY	REMARKS
①	CABLE	UL 20276 O.D. 5.5mm COLOR: BLACK	1	
②	MICRO USB3.0 A B M 10PIN GOLD PLATED	15U" SHELL NICKEL PLATED INSULATOR BLACK	1	
③	USB3.0 B M 9PIN GOLD PLATED	30U" SHELL NICKEL PLATED INSULATOR BLUE	1	
④	PVC	45P PVC BLACK	18	g
⑤	PE	CLEAR PE	2	g
⑥	CABLE TIE	L=9cm COLOR: BLACK	2	

NOTES:

- CABLE: UL20276
(1Px30AWG+D+AL+MY)x2C+1Px30AWG+2Cx24AWG+AL+B
OUTER JACKET: BLACK, O.D.: 5.5mm
- CONNECTORS: MICRO USB 3.0 A MALE TO USB 3.0 B MALE
- HOOD: MOLDED TYPE, COLOR: BLACK
- PACKING: 1PC/POLYBAG
- RoHS COMPLIANT

Qualtek Electronics Corp.
WCI DIVISION

Part Number: **3023033-03M**



Description:
MICRO USB 3.0 A B/M - USB 3.0 B/M

Dim range (mm)	Tolerance +/- (mm)	UNIT: mm		
0-1	0.15	Drawn / Date	Checked / Date	Approved / Date
1-6	0.20			
6-18	0.30	R.Nuti 06-25-10	06-25-10	LY / 06-25-10
18-50	0.50			
50-120	0.70			
120-250	0.90			
250-500	1.20			