



Chipsmall Limited consists of a professional team with an average of over 10 year of expertise in the distribution of electronic components. Based in Hongkong, we have already established firm and mutual-benefit business relationships with customers from,Europe,America and south Asia,supplying obsolete and hard-to-find components to meet their specific needs.

With the principle of “Quality Parts,Customers Priority,Honest Operation,and Considerate Service”,our business mainly focus on the distribution of electronic components. Line cards we deal with include Microchip,ALPS,ROHM,Xilinx,Pulse,ON,Everlight and Freescale. Main products comprise IC,Modules,Potentiometer,IC Socket,Relay,Connector.Our parts cover such applications as commercial,industrial, and automotives areas.

We are looking forward to setting up business relationship with you and hope to provide you with the best service and solution. Let us make a better world for our industry!



Contact us

Tel: +86-755-8981 8866 Fax: +86-755-8427 6832

Email & Skype: info@chipsmall.com Web: www.chipsmall.com

Address: A1208, Overseas Decoration Building, #122 Zhenhua RD., Futian, Shenzhen, China





FEATURES

- Low-profile surface-mount design
- Inductance Range from 80nH to 200nH
- Rated current up to 57A_{pk}
- Materials meet UL94V-0
- Custom inductance values available
- RoHS compliant
- J-STD-020 D.1 reflow

PRODUCT OVERVIEW

The 3000A series are a range of high-current, surface-mount bead inductors, suited to a variety of applications. The products are designed for noise suppression in high-frequency, high-current switching power supplies, DC-DC converters, DC-AC inverters and VRMs.

SELECTION GUIDE

Order Code	Inductance (1MHz, 0.1V)		I _{DC} ³	I _{SAT} (Typ.) ⁴		DC Resistance	
	±20%	Typ. @ I _{DC}		25 °C	100 °C	Typ.	Max.
	nH	nH	A	A	A	mΩ	mΩ
30800AC	80	82	37	57	47	0.19	0.35
30101AC	97	105	36	48	41	0.20	0.35
30151AC	145	120	29	33	29	0.19	0.35
30201AC	191	162	22	24	22	0.21	0.35

ABSOLUTE MAXIMUM RATINGS

Operating temperature range	-40°C to +130°C
Storage temperature range	-40°C to +155°C

SOLDERING INFORMATION¹

Peak reflow solder temperature	250°C
Pin finish	SAC305
Moisture sensitivity level ²	1

Mechanical Dimensions

Mechanical Dimensions

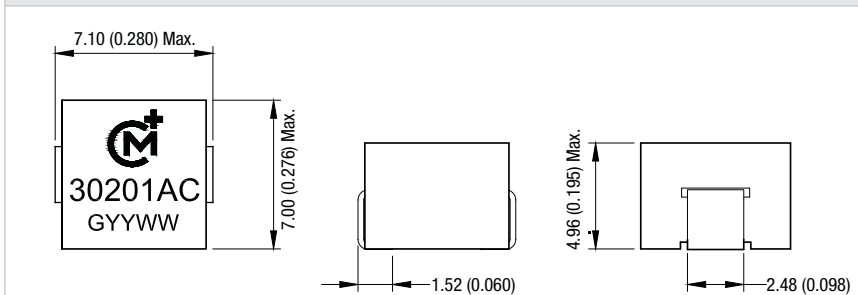

Weight Typ. = 0.94g

Recommended Pad Layout

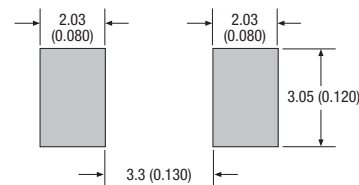

Unless otherwise stated, all dimensions in mm (inches) ± 0.25 (0.010).

Specifications typical at T_A = 25°C

1 For further information, please visit www.murata-ps.com/rohs

2 Representative samples of the product were subjected to the conditioning described in IPC/JEDEC J-STD-020D and passed electrical testing, package coplanarity and visual inspection which revealed no external cracks or changes in package body flatness.

3 I_{DC} is the value at which the inductance falls to 80% of its nominal value or when its temperature reaches 40°C, whichever is sooner.

4 I_{SAT} is the value at which the inductance falls to 80% of its nominal value.



For full details go to
www.murata-ps.com/rohs

INDUCTANCE Vs CURRENT

3000A Series Inductance Vs Current

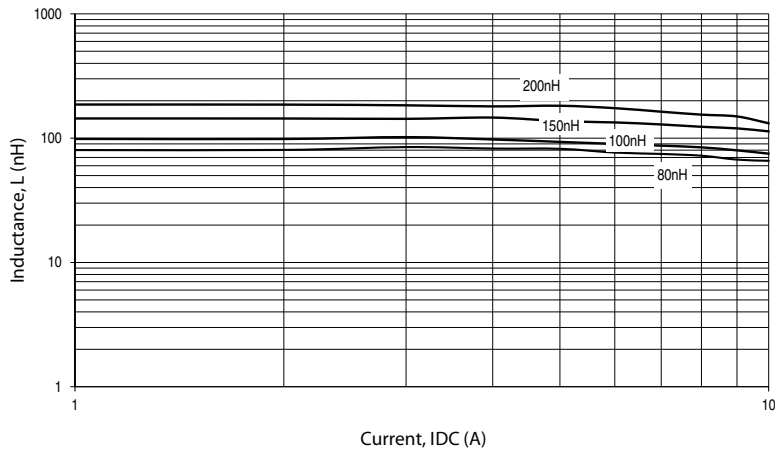

TEMPERATURE Vs CURRENT

3000A Temperature Vs Current

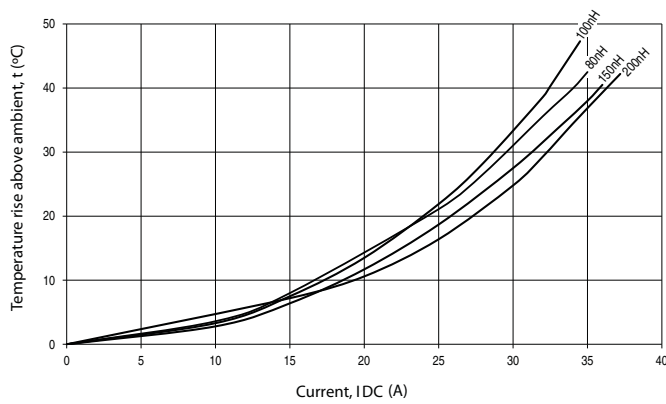

INDUCTANCE Vs FREQUENCY

3000A Series Inductance Vs Frequency

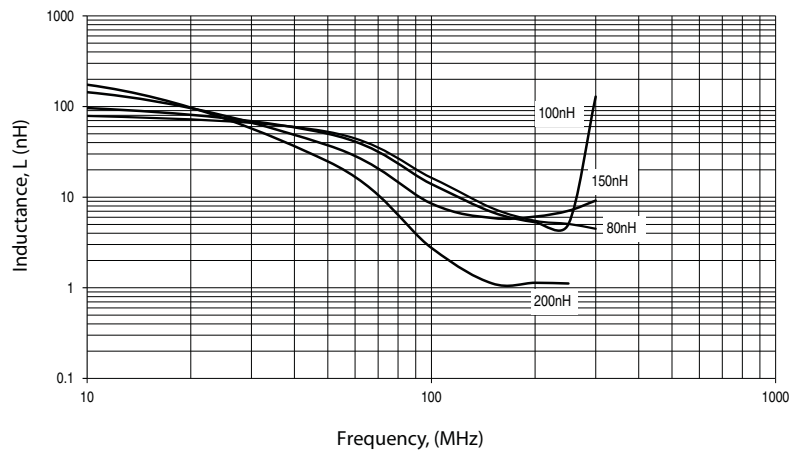

PACKAGE SPECIFICATIONS

Reel Dimensions

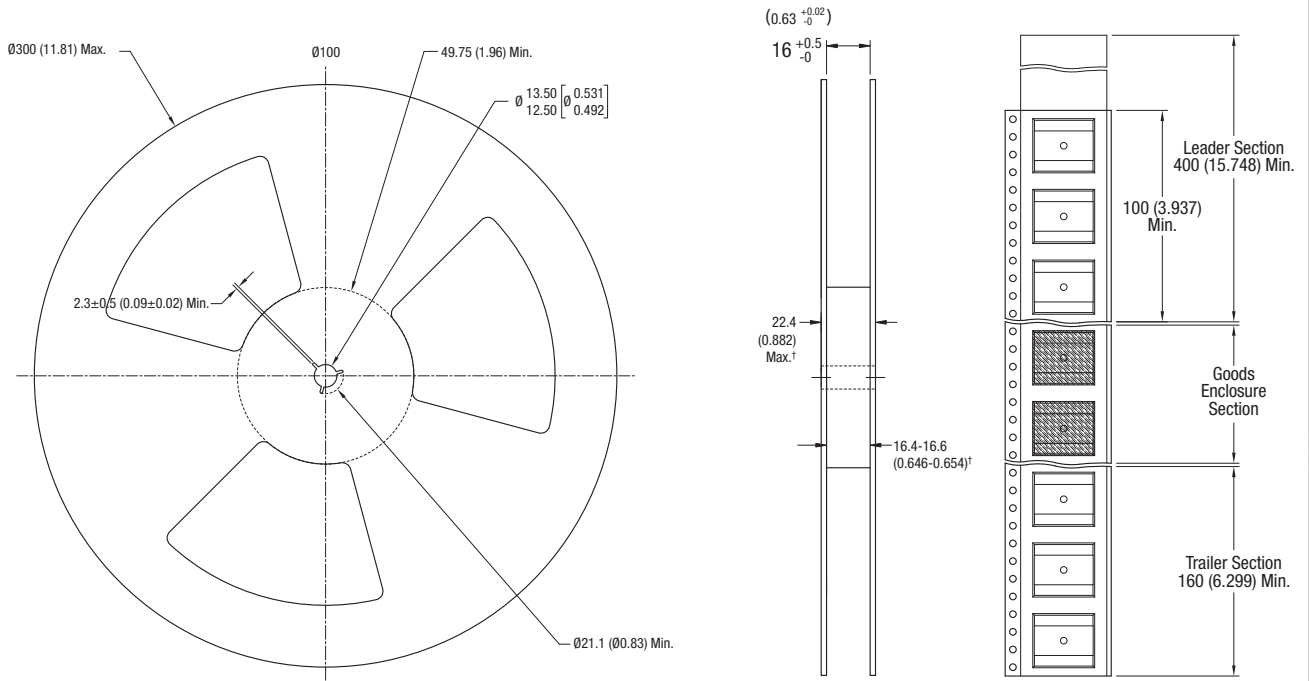

Reel Dimensions

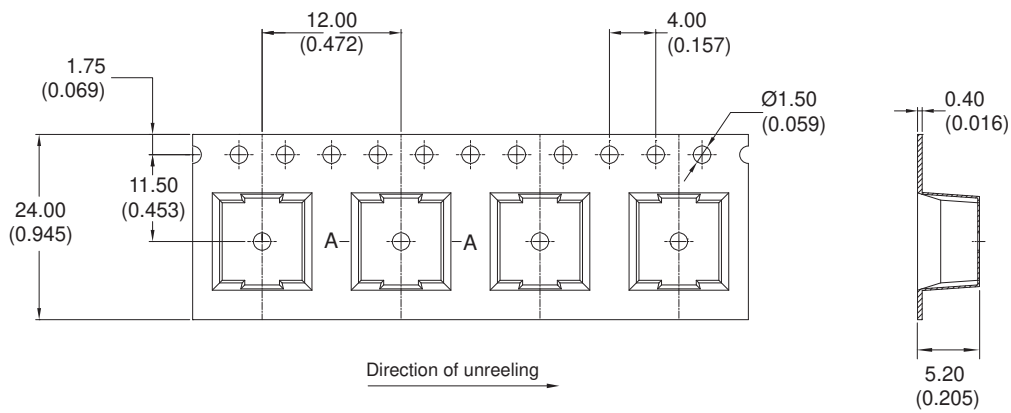

Reel quantity: 1000

Murata Power Solutions, Inc.
11 Cabot Boulevard, Mansfield, MA 02048-1151 U.S.A.
ISO 9001 and 14001 REGISTERED

Murata Power Solutions, Inc. makes no representation that the use of its products in the circuits described herein, or the use of other technical information contained herein, will not infringe upon existing or future patent rights. The descriptions contained herein do not imply the granting of licenses to make, use, or sell equipment constructed in accordance therewith. Specifications are subject to change without notice. © 2013 Murata Power Solutions, Inc.