



Chipsmall Limited consists of a professional team with an average of over 10 year of expertise in the distribution of electronic components. Based in Hongkong, we have already established firm and mutual-benefit business relationships with customers from,Europe,America and south Asia,supplying obsolete and hard-to-find components to meet their specific needs.

With the principle of “Quality Parts,Customers Priority,Honest Operation,and Considerate Service”,our business mainly focus on the distribution of electronic components. Line cards we deal with include Microchip,ALPS,ROHM,Xilinx,Pulse,ON,Everlight and Freescale. Main products comprise IC,Modules,Potentiometer,IC Socket,Relay,Connector.Our parts cover such applications as commercial,industrial, and automotives areas.

We are looking forward to setting up business relationship with you and hope to provide you with the best service and solution. Let us make a better world for our industry!



## Contact us

Tel: +86-755-8981 8866 Fax: +86-755-8427 6832

Email & Skype: info@chipsmall.com Web: www.chipsmall.com

Address: A1208, Overseas Decoration Building, #122 Zhenhua RD., Futian, Shenzhen, China





**30CTQ060**  
**30CTQ060S**  
**30CTQ060 -1**

**SCHOTTKY RECTIFIER**

**30 Amp**

$I_{F(AV)} = 30\text{Amp}$   
 $V_R = 50 - 60\text{V}$





**Major Ratings and Characteristics**

Characteristics	30CTQ	Units
$I_{F(AV)}$ Rectangular waveform	30	A
$V_{RRM}$	50 - 60	V
$I_{FSM}$ @ tp = 5 $\mu\text{s}$ sine	1000	A
$V_F$ @ 15 Apk, $T_J = 125^\circ\text{C}$ (per leg)	0.56	V
$T_J$ range	-55 to 150	$^\circ\text{C}$

**Description/ Features**

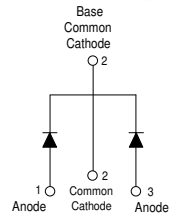
This center tap Schottky rectifier has been optimized for very low forward voltage drop, with moderate leakage. The proprietary barrier technology allows for reliable operation up to 150° C junction temperature. Typical applications are in switching power supplies, converters, free-wheeling diodes, and reverse battery protection.

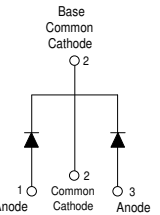
- 150° C  $T_J$  operation
- Center tap configuration
- Very low forward voltage drop
- High purity, high temperature epoxy encapsulation for enhanced mechanical strength and moisture resistance
- High frequency operation
- Guard ring for enhanced ruggedness and long term reliability

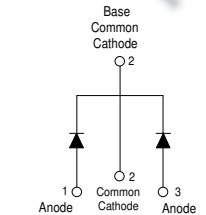
Case Styles		
<p><b>30CTQ...</b></p>   <p><b>TO-220</b></p>	<p><b>30CTQ... S</b></p>   <p><b>D<sup>2</sup>PAK</b></p>	<p><b>30CTQ... -1</b></p>   <p><b>TO-262</b></p>

## Voltage Ratings

Part number	30CTQ050	30CTQ060
$V_R$ Max. DC Reverse Voltage (V)	50	60
$V_{RWM}$ Max. Working Peak Reverse Voltage (V)		

## Absolute Maximum Ratings

Parameters	Values	Units	Conditions
$I_{F(AV)}$ Max. Average Forward Current (Per Leg) * See Fig. 5 (Per Device)	15	A	50% duty cycle @ $T_C = 105^\circ\text{C}$ , rectangular wave form
	30		
$I_{FSM}$ Max. Peak One Cycle Non-Repetitive Surge Current (Per Leg) * See Fig. 7	1000	A	5 $\mu\text{s}$ Sine or 3 $\mu\text{s}$ Rect. pulse
	260		10ms Sine or 6ms Rect. pulse
$E_{AS}$ Non-Repetitive Avalanche Energy (Per Leg)	13	mJ	$T_J = 25^\circ\text{C}$ , $I_{AS} = 1.50$ Amps, $L = 11.5$ mH
$I_{AR}$ Repetitive Avalanche Current (Per Leg)	1.50	A	Current decaying linearly to zero in 1 $\mu\text{sec}$ Frequency limited by $T_J$ max. $V_A = 1.5 \times V_R$ typical

## Electrical Specifications

Parameters	Values	Units	Conditions
$V_{FM}$ Max. Forward Voltage Drop (Per Leg) * See Fig. 1 (1)	0.62	V	@ 15A
	0.82	V	@ 30A
	0.56	V	@ 15A
	0.71	V	@ 30A
$I_{RM}$ Max. Reverse Leakage Current (Per Leg) * See Fig. 2 (1)	0.80	mA	$T_J = 25^\circ\text{C}$
	45	mA	$T_J = 125^\circ\text{C}$
$V_{F(TO)}$ Threshold Voltage	0.39	V	$T_J = T_J$ max.
$r_t$ Forward Slope Resistance	8.47	m $\Omega$	
$C_T$ Max. Junction Capacitance (Per Leg)	720	pF	$V_R = 5V_{DC}$ (test signal range 100Khz to 1Mhz) $25^\circ\text{C}$
$L_S$ Typical Series Inductance (Per Leg)	8.0	nH	Measured lead to lead 5mm from package body
dv/dt Max. Voltage Rate of Change (Rated $V_R$ )	10000	V/ $\mu\text{s}$	

(1) Pulse Width < 300 $\mu\text{s}$ , Duty Cycle <2%

## Thermal-Mechanical Specifications

Parameters	Values	Units	Conditions
$T_J$ Max. Junction Temperature Range	-55 to 150	$^\circ\text{C}$	
$T_{stg}$ Max. Storage Temperature Range	-55 to 150	$^\circ\text{C}$	
$R_{thJC}$ Max. Thermal Resistance Junction to Case (Per Leg)	3.25	$^\circ\text{C}/\text{W}$	DC operation
$R_{thJC}$ Max. Thermal Resistance Junction to Case (Per Package)	1.63	$^\circ\text{C}/\text{W}$	DC operation
$R_{thCS}$ Typical Thermal Resistance, Case to Heatsink	0.50	$^\circ\text{C}/\text{W}$	Mounting surface, smooth and greased (only for TO-220)
wt Approximate Weight	2 (0.07)	g (oz.)	
T Mounting Torque	Min.	6 (5)	Kg-cm (lbf-in)
	Max.	12 (10)	

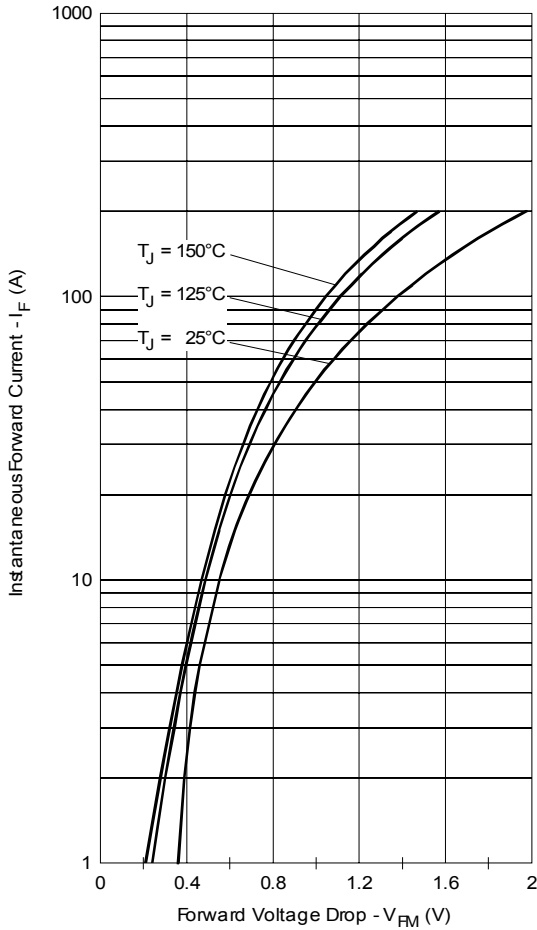

Fig. 1 - Max. Forward Voltage Drop Characteristics (Per Leg)

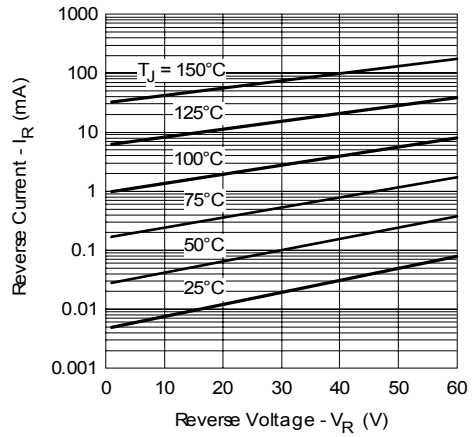

Fig. 2 - Typical Values Of Reverse Current Vs. Reverse Voltage (Per Leg)

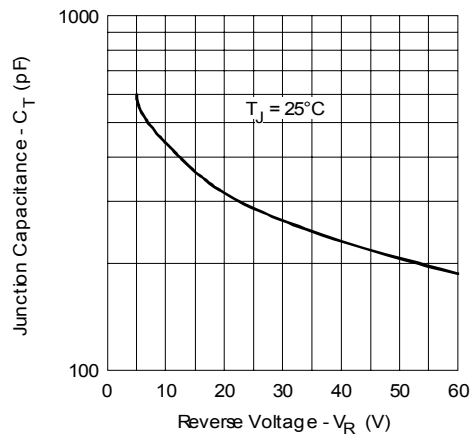

Fig. 3 - Typical Junction Capacitance Vs. Reverse Voltage (Per Leg)

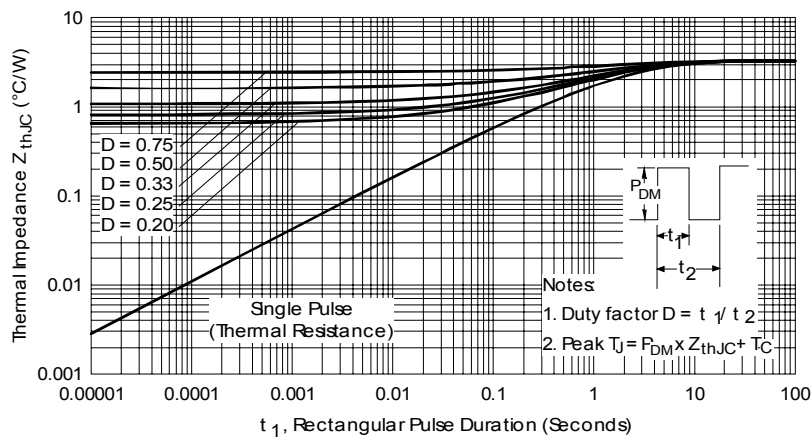

Fig. 4 - Max. Thermal Impedance  $Z_{thJC}$  Characteristics (Per Leg)



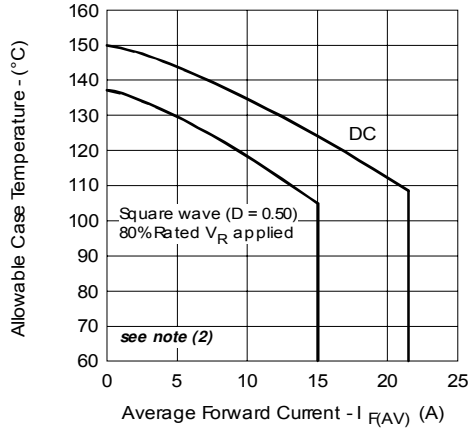

Fig. 5 - Max. Allowable Case Temperature Vs. Average Forward Current (Per Leg)

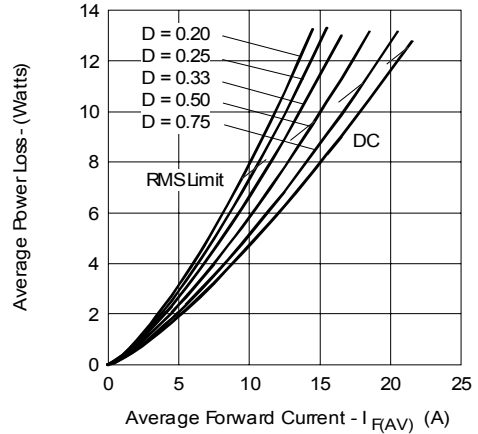

Fig. 6 - Forward Power Loss Characteristics (Per Leg)

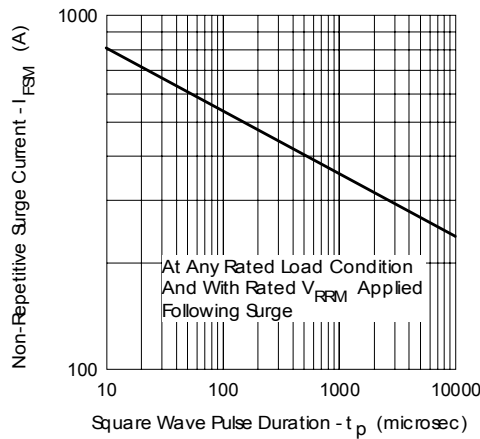

Fig. 7 - Max. Non-Repetitive Surge Current (Per Leg)

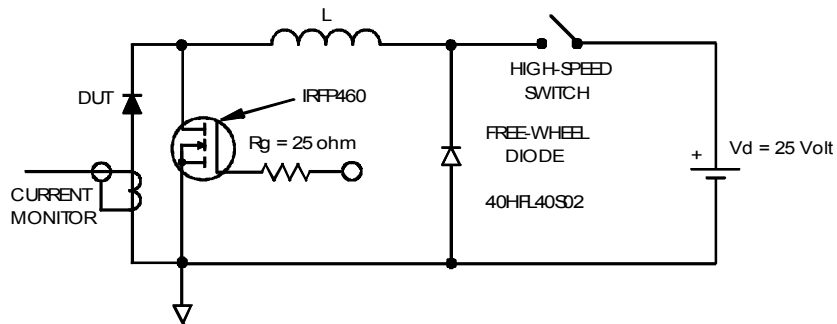
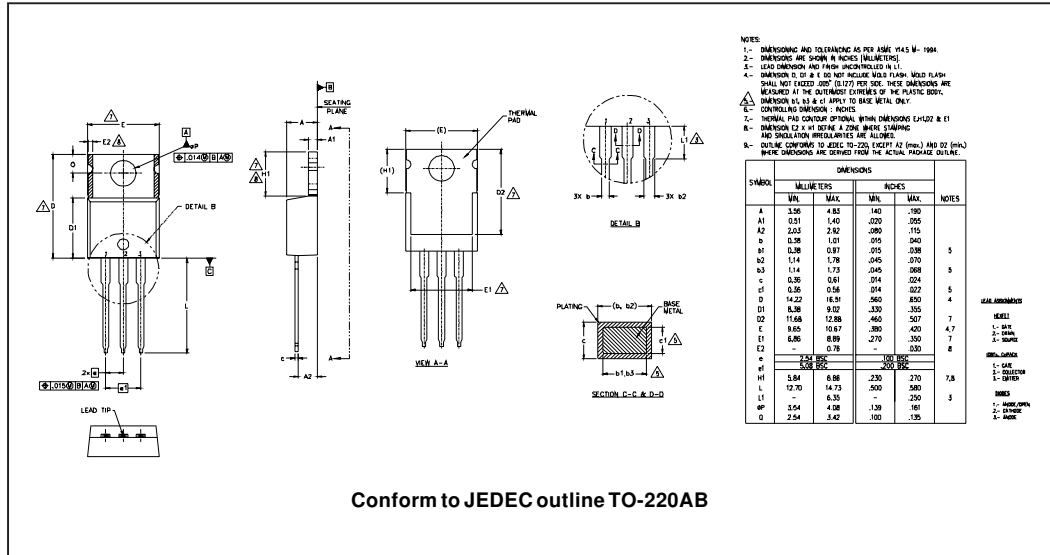

Fig. 8 - Unclamped Inductive Test Circuit

- (2) Formula used:  $T_c = T_j - (Pd + Pd_{REV}) \times R_{thJC}$ ;  
 $Pd = \text{Forward Power Loss} = I_{F(AV)} \times V_{FM} @ (I_{F(AV)} / D)$  (see Fig. 6);  
 $Pd_{REV} = \text{Inverse Power Loss} = V_{R1} \times I_{R1} (1 - D); I_{R1} @ V_{R1} = 10 \text{ V}$

Outline Table



Conform to JEDEC outline TO-220AB

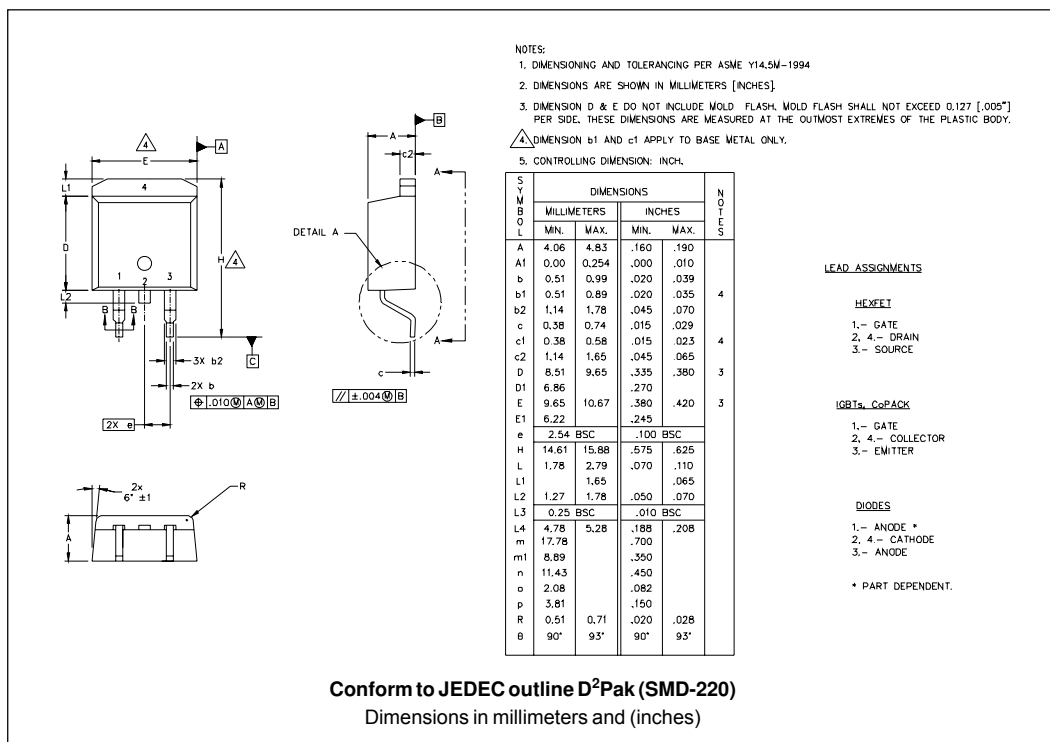

Conform to JEDEC outline D<sup>2</sup>Pak (SMD-220)  
 Dimensions in millimeters and (inches)

Outline Table

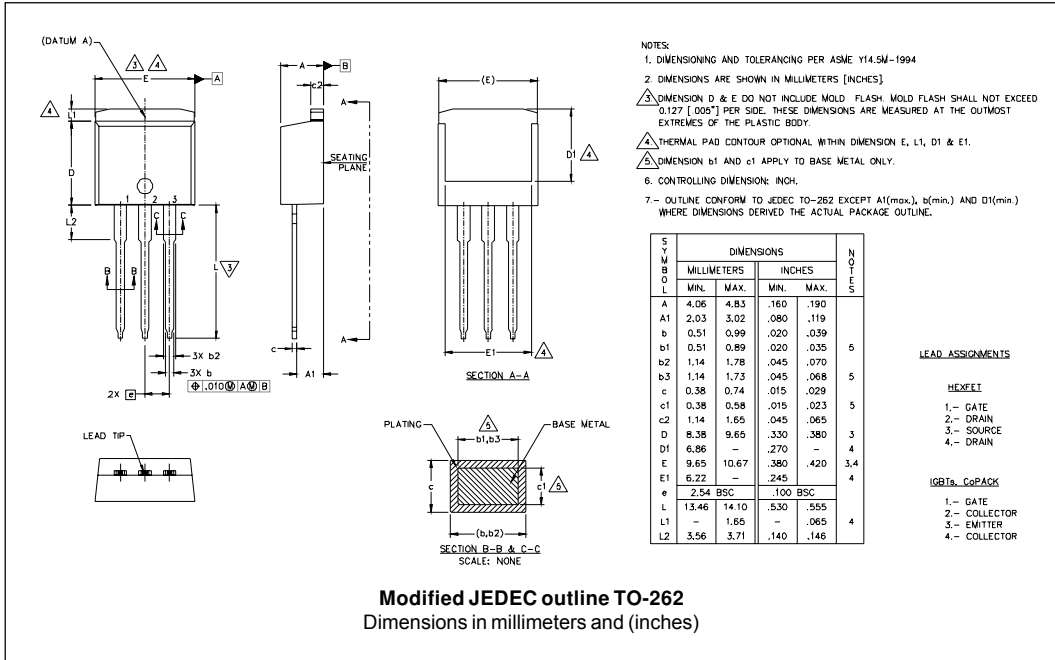

Tape & Reel Information

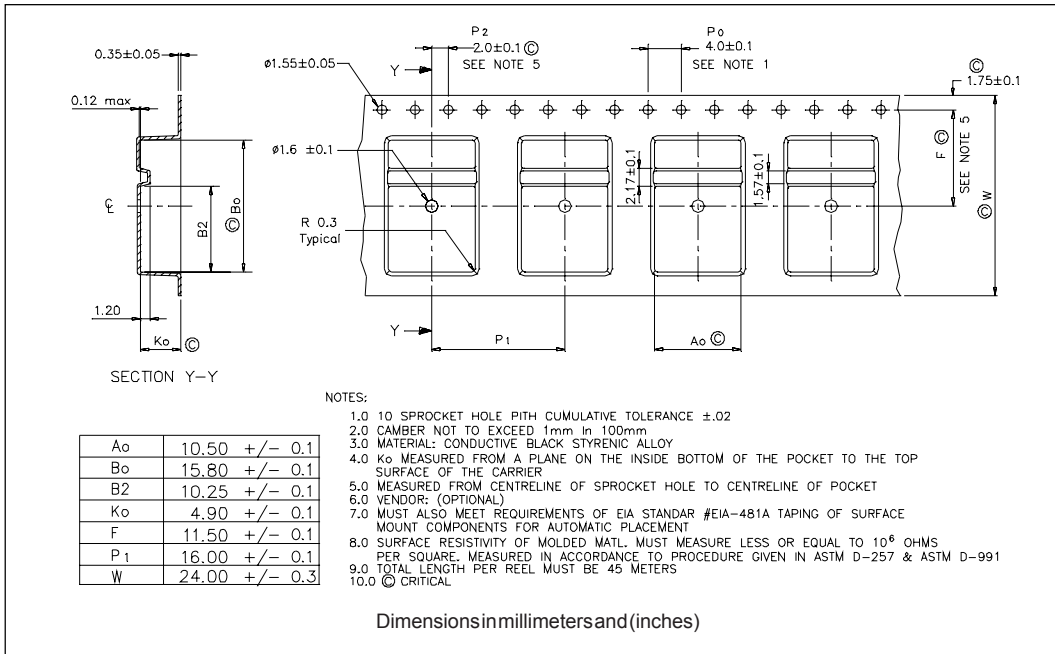

Part Marking Information

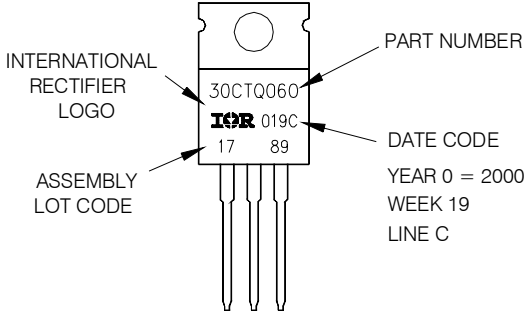
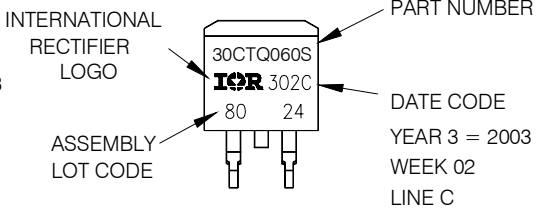
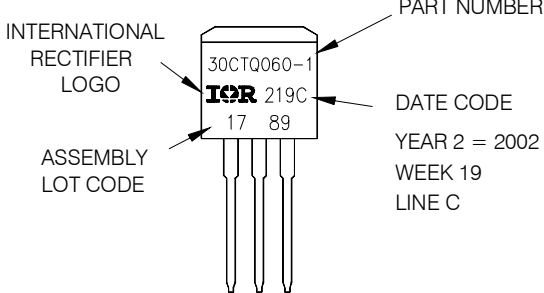
<p>TO-220</p>	<p>EXAMPLE: THIS IS A 30CTQ060                  LOT CODE 1789                  ASSEMBLED ON WW 19, 2000                  IN THE ASSEMBLY LINE "C"</p>	 <p>INTERNATIONAL RECTIFIER LOGO</p> <p>ASSEMBLY LOT CODE</p> <p>PART NUMBER</p> <p>DATE CODE                  YEAR 0 = 2000                  WEEK 19                  LINE C</p>
<p>D<sup>2</sup>PAK</p>	<p>EXAMPLE: THIS IS A 30CTQ060S                  LOT CODE 8024                  ASSEMBLED ON WW 02, 2003                  IN ASSEMBLY LINE "C"</p>	 <p>INTERNATIONAL RECTIFIER LOGO</p> <p>ASSEMBLY LOT CODE</p> <p>PART NUMBER</p> <p>DATE CODE                  YEAR 3 = 2003                  WEEK 02                  LINE C</p>
<p>TO-262</p>	<p>EXAMPLE: THIS IS A 30CTQ060-1                  LOT CODE 1789                  ASSEMBLED ON WW 19, 2002                  IN ASSEMBLY LINE "C"</p>	 <p>INTERNATIONAL RECTIFIER LOGO</p> <p>ASSEMBLY LOT CODE</p> <p>PART NUMBER</p> <p>DATE CODE                  YEAR 2 = 2002                  WEEK 19                  LINE C</p>



Ordering Information Table

Device Code		30	C	T	Q	060	S	TRL	-		
		①	②	③	④	⑤	⑥	⑦	⑧		
<b>1</b>	-	Current Rating (30A)									
<b>2</b>	-	Circuit Configuration									
		C = Common Cathode									
<b>3</b>	-	T = TO-220									
<b>4</b>	-	Schottky "Q" Series									
<b>5</b>	-	Voltage Ratings									
		<table border="1"> <tr> <td>050 = 50V</td> </tr> <tr> <td>060 = 60V</td> </tr> </table>								050 = 50V	060 = 60V
050 = 50V											
060 = 60V											
<b>6</b>	-	<ul style="list-style-type: none"> <li>• S = D<sup>2</sup>Pak</li> <li>• -1= TO-262</li> </ul>									
<b>7</b>	-	<ul style="list-style-type: none"> <li>• none = Tube (50 pieces)</li> <li>• TRL = Tape &amp; Reel (Left Oriented - for D<sup>2</sup>Pak only)</li> <li>• TRR = Tape &amp; Reel (Right Oriented - for D<sup>2</sup>Pak only)</li> </ul>									
<b>8</b>	-	<ul style="list-style-type: none"> <li>• none = Standard Production</li> <li>• PbF = Lead-Free</li> </ul>									

Data and specifications subject to change without notice.  
 This product has been designed and qualified for Industrial Level.  
 Qualification Standards can be found on IR's Web site.



## Notice

The products described herein were acquired by Vishay Intertechnology, Inc., as part of its acquisition of International Rectifier's Power Control Systems (PCS) business, which closed in April 2007. Specifications of the products displayed herein are pending review by Vishay and are subject to the terms and conditions shown below.

Specifications of the products displayed herein are subject to change without notice. Vishay Intertechnology, Inc., or anyone on its behalf, assumes no responsibility or liability for any errors or inaccuracies.

Information contained herein is intended to provide a product description only. No license, express or implied, by estoppel or otherwise, to any intellectual property rights is granted by this document. Except as provided in Vishay's terms and conditions of sale for such products, Vishay assumes no liability whatsoever, and disclaims any express or implied warranty, relating to sale and/or use of Vishay products including liability or warranties relating to fitness for a particular purpose, merchantability, or infringement of any patent, copyright, or other intellectual property right.

The products shown herein are not designed for use in medical, life-saving, or life-sustaining applications. Customers using or selling these products for use in such applications do so at their own risk and agree to fully indemnify Vishay for any damages resulting from such improper use or sale.

International Rectifier®, IR®, the IR logo, HEXFET®, HEXSense®, HEXDIP®, DOL®, INTERO®, and POWIRTRAIN® are registered trademarks of International Rectifier Corporation in the U.S. and other countries. All other product names noted herein may be trademarks of their respective owners.