



Chipsmall Limited consists of a professional team with an average of over 10 year of expertise in the distribution of electronic components. Based in Hongkong, we have already established firm and mutual-benefit business relationships with customers from,Europe,America and south Asia,supplying obsolete and hard-to-find components to meet their specific needs.

With the principle of “Quality Parts,Customers Priority,Honest Operation,and Considerate Service”,our business mainly focus on the distribution of electronic components. Line cards we deal with include Microchip,ALPS,ROHM,Xilinx,Pulse,ON,Everlight and Freescale. Main products comprise IC,Modules,Potentiometer,IC Socket,Relay,Connector.Our parts cover such applications as commercial,industrial, and automotives areas.

We are looking forward to setting up business relationship with you and hope to provide you with the best service and solution. Let us make a better world for our industry!



Contact us

Tel: +86-755-8981 8866 Fax: +86-755-8427 6832

Email & Skype: info@chipsmall.com Web: www.chipsmall.com

Address: A1208, Overseas Decoration Building, #122 Zhenhua RD., Futian, Shenzhen, China



Pressfit Indicator Lights for 1/2 Dia. Mounting Hole

32/35 SERIES

- PRESSFIT INDICATOR LIGHTS
- NEON, LED & INCANDESCENT
- 2 TO 600 DESIGN VOLTS
- 3/16" TAB TERMINALS
- VARIETY OF LENS COLORS
- UL LISTED • UL FILE E20356

Overview

The 32/35 Series Indicators feature a wide variety of lenses, colors, voltage & bezel variations. Indicators quickly pressfit into a 0.500" to 0.510" mounting hole with recommended panel thickness range of 0.020" min. to 0.090" max. A speednut, part number **8700071674**, and Adapters for 0.514" to 0.519" are available.

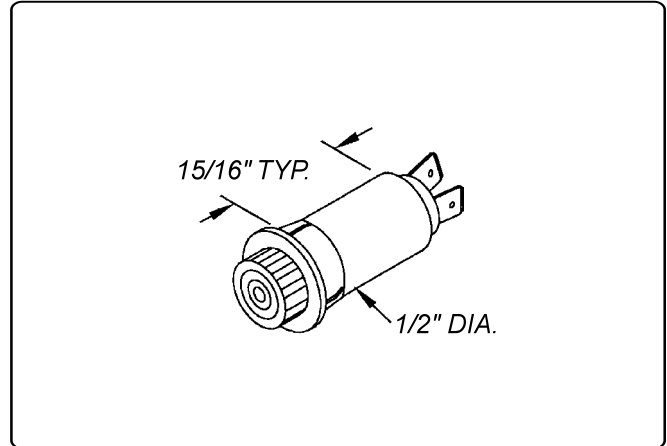

Specifications

Housing: white nylon. A black housing is available.

Bezel: nickel plated brass. A black anodized bezel is available.

Lens: polycarbonate.

Incandescent AC or DC voltage options: 6, 14 and 28 volts.

Neon AC or DC voltage options: 125, 250 and 600 volts. **Note:** high brightness green and blue neon lamps supplied in green and blue neon applications.

LED DC voltage options: 2, 6, 12, 24 volts.

LED AC voltage options: 125 volts.

Note: 125 volts AC units contain a bi-polar LED.

Terminals:

3/16" tabs: brass, (0.187" length x 0.020" thick). For LED units, a tin plated terminal denotes the anode (+). 1/4" or 1/8" brass tab terminals are available.

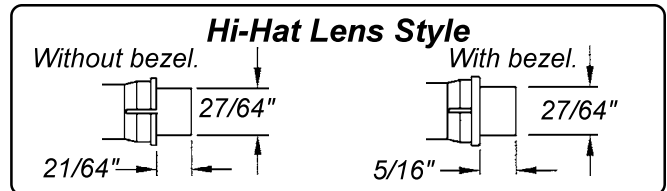
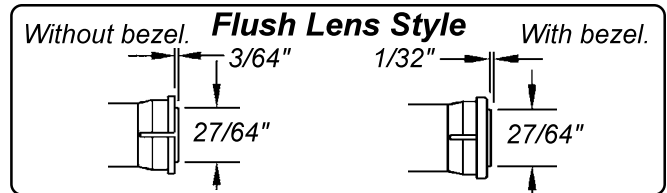
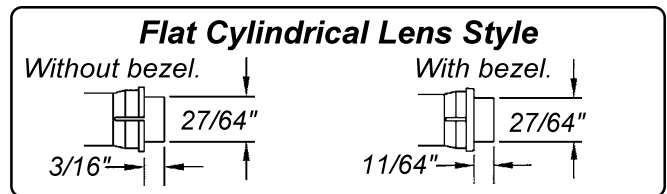

Pressfit Indicator Lights for 1/2 Dia. Mounting Hole

32/35 SERIES
Flat Cylindrical Lens
Without Bezel
Neon or
Incandescent

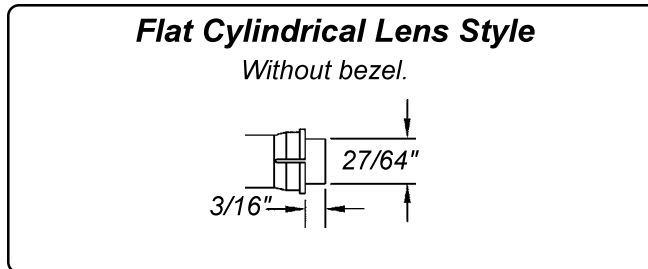

3/16" Tab Terminals
White Housing
6 to 250 Design Volts
PressFit Mounting

Part Number 3/16" Tab Terminals	Lens Color	Lamp Type	Design Volts	Design Watts or Amps	Life (hrs)
32-2111T	Red	Neon	125	1/3W	25,000
35-2111T	Red	Neon	250	1/3W	25,000
32G1-2111T	Red	Incandescent	6	.20A	5,000
32G3-2111T	Red	Incandescent	14	.10A	10,000
32G18-2111T	Red	Incandescent	28	.04A	7,000
32-2112T	Green	Neon	125	1/3W	25,000
35-2112T	Green	Neon	250	1/3W	25,000
32G1-2112T	Green	Incandescent	6	.20A	5,000
32G3-2112T	Green	Incandescent	14	.10A	10,000
32G18-2112T	Green	Incandescent	28	.04A	7,000
32-2113T	Amber	Neon	125	1/3W	25,000
35-2113T	Amber	Neon	250	1/3W	25,000
32G1-2113T	Amber	Incandescent	6	.20A	5,000
32G3-2113T	Amber	Incandescent	14	.10A	10,000
32G18-2113T	Amber	Incandescent	28	.04A	7,000
32-2114T	Blue	Neon	125	1/3W	25,000
35-2114T	Blue	Neon	250	1/3W	25,000
32G1-2114T	Blue	Incandescent	6	.20A	5,000
32G3-2114T	Blue	Incandescent	14	.10A	10,000
32G18-2114T	Blue	Incandescent	28	.04A	7,000
32-2115T	White	Neon	125	1/3W	25,000
35-2115T	White	Neon	250	1/3W	25,000
32G1-2115T	White	Incandescent	6	.20A	5,000
32G3-2115T	White	Incandescent	14	.10A	10,000
32G18-2115T	White	Incandescent	28	.04A	7,000
32-2117T	Clear	Neon	125	1/3W	25,000
35-2117T	Clear	Neon	250	1/3W	25,000
32G1-2117T	Clear	Incandescent	6	.20A	5,000
32G3-2117T	Clear	Incandescent	14	.10A	10,000
32G18-2117T	Clear	Incandescent	28	.04A	7,000

Pressfit Indicator Lights for 1/2 Dia. Mounting Hole

32/35 SERIES
Flat Cylindrical Lens
Nickel Plated Bezel
Neon or
Incandescent

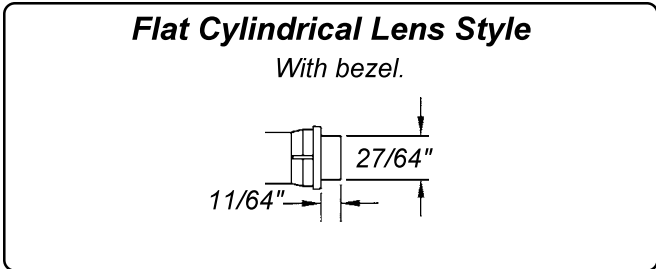

3/16" Tab Terminals
White Housing
6 to 250 Design Volts
PressFit Mounting

Part Number 3/16" Tab Terminals	Lens Color	Lamp Type	Design Volts	Design Watts or Amps	Life (hrs)
32R-2111T	Red	Neon	125	1/3W	25,000
35R-2111T	Red	Neon	250	1/3W	25,000
32RG1-2111T	Red	Incandescent	6	.20A	5,000
32RG3-2111T	Red	Incandescent	14	.10A	10,000
32RG18-2111T	Red	Incandescent	28	.04A	7,000
32R-2112T	Green	Neon	125	1/3W	25,000
35R-2112T	Green	Neon	250	1/3W	25,000
32RG1-2112T	Green	Incandescent	6	.20A	5,000
32RG3-2112T	Green	Incandescent	14	.10A	10,000
32RG18-2112T	Green	Incandescent	28	.04A	7,000
32R-2113T	Amber	Neon	125	1/3W	25,000
35R-2113T	Amber	Neon	250	1/3W	25,000
32RG1-2113T	Amber	Incandescent	6	.20A	5,000
32RG3-2113T	Amber	Incandescent	14	.10A	10,000
32RG18-2113T	Amber	Incandescent	28	.04A	7,000
32R-2114T	Blue	Neon	125	1/3W	25,000
35R-2114T	Blue	Neon	250	1/3W	25,000
32RG1-2114T	Blue	Incandescent	6	.20A	5,000
32RG3-2114T	Blue	Incandescent	14	.10A	10,000
32RG18-2114T	Blue	Incandescent	28	.04A	7,000
32R-2115T	White	Neon	125	1/3W	25,000
35R-2115T	White	Neon	250	1/3W	25,000
32RG1-2115T	White	Incandescent	6	.20A	5,000
32RG3-2115T	White	Incandescent	14	.10A	10,000
32RG18-2115T	White	Incandescent	28	.04A	7,000
32R-2117T	Clear	Neon	125	1/3W	25,000
35R-2117T	Clear	Neon	250	1/3W	25,000
32RG1-2117T	Clear	Incandescent	6	.20A	5,000
32RG3-2117T	Clear	Incandescent	14	.10A	10,000
32RG18-2117T	Clear	Incandescent	28	.04A	7,000

Pressfit Indicator Lights for 1/2 Dia. Mounting Hole

32/35 SERIES

Flush Lens
Without Bezel
Neon or
Incandescent

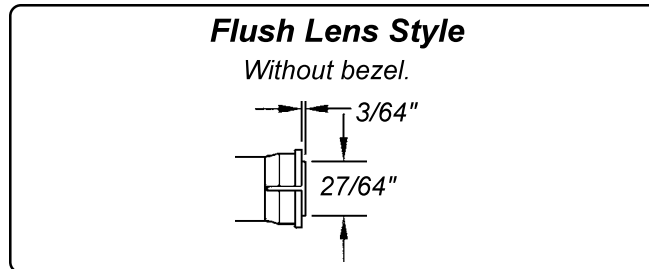

3/16" Tab Terminals
White Housing
6 to 250 Design Volts
PressFit Mounting

Part Number 3/16" Tab Terminals	Lens Color	Lamp Type	Design Volts	Design Watts or Volts	Life (hrs)
32-2311T	Red	Neon	125	1/3W	25,000
35-2311T	Red	Neon	250	1/3W	25,000
32G1-2311T	Red	Incandescent	6	.20A	5,000
32G3-2311T	Red	Incandescent	14	.10A	10,000
32G18-2311T	Red	Incandescent	28	.04A	7,000
32-2312T	Green	Neon	125	1/3W	25,000
35-2312T	Green	Neon	250	1/3W	25,000
32G1-2312T	Green	Incandescent	6	.20A	5,000
32G3-2312T	Green	Incandescent	14	.10A	10,000
32G18-2312T	Green	Incandescent	28	.04A	7,000
32-2313T	Amber	Neon	125	1/3W	25,000
35-2313T	Amber	Neon	250	1/3W	25,000
32G1-2313T	Amber	Incandescent	6	.20A	5,000
32G3-2313T	Amber	Incandescent	14	.10A	10,000
32G18-2313T	Amber	Incandescent	28	.04A	7,000
32-2314T	Blue	Neon	125	1/3W	25,000
35-2314T	Blue	Neon	250	1/3W	25,000
32G1-2314T	Blue	Incandescent	6	.20A	5,000
32G3-2314T	Blue	Incandescent	14	.10A	10,000
32G18-2314T	Blue	Incandescent	28	.04A	7,000
32-2315T	White	Neon	125	1/3W	25,000
35-2315T	White	Neon	250	1/3W	25,000
32G1-2315T	White	Incandescent	6	.20A	5,000
32G3-2315T	White	Incandescent	14	.10A	10,000
32G18-2315T	White	Incandescent	28	.04A	7,000
32-2317T	Clear	Neon	125	1/3W	25,000
35-2317T	Clear	Neon	250	1/3W	25,000
32G1-2317T	Clear	Incandescent	6	.20A	5,000
32G3-2317T	Clear	Incandescent	14	.10A	10,000
32G18-2317T	Clear	Incandescent	28	.04A	7,000

Pressfit Indicator Lights for 1/2 Dia. Mounting Hole

32/35 SERIES

Flush Lens
Nickel Plated Bezel
Neon or
Incandescent

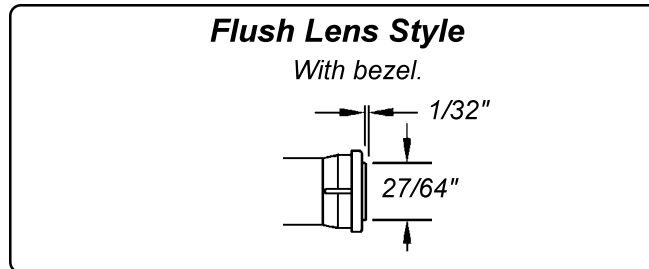

3/16" Tab Terminals
White Housing
6 to 250 Design Volts
PressFit Mounting

Part Number 3/16" Tab Terminals	Lens Color	Lamp Type	Design Volts	Design Watts or Amps	Life (hrs)
32R-2311T	Red	Neon	125	1/3W	25,000
35R-2311T	Red	Neon	250	1/3W	25,000
32RG1-2311T	Red	Incandescent	6	.20A	5,000
32RG3-2311T	Red	Incandescent	14	.10A	10,000
32RG18-2311T	Red	Incandescent	28	.04A	7,000
32R-2312T	Green	Neon	125	1/3W	25,000
35R-2312T	Green	Neon	250	1/3W	25,000
32RG1-2312T	Green	Incandescent	6	.20A	5,000
32RG3-2312T	Green	Incandescent	14	.10A	10,000
32RG18-2312T	Green	Incandescent	28	.04A	7,000
32R-2313T	Amber	Neon	125	1/3W	25,000
35R-2313T	Amber	Neon	250	1/3W	25,000
32RG1-2313T	Amber	Incandescent	6	.20A	5,000
32RG3-2313T	Amber	Incandescent	14	.10A	10,000
32RG18-2313T	Amber	Incandescent	28	.04A	7,000
32R-2314T	Blue	Neon	125	1/3W	25,000
35R-2314T	Blue	Neon	250	1/3W	25,000
32RG1-2314T	Blue	Incandescent	6	.20A	5,000
32RG3-2314T	Blue	Incandescent	14	.10A	10,000
32RG18-2314T	Blue	Incandescent	28	.04A	7,000
32R-2315T	White	Neon	125	1/3W	25,000
35R-2315T	White	Neon	250	1/3W	25,000
32RG1-2315T	White	Incandescent	6	.20A	5,000
32RG3-2315T	White	Incandescent	14	.10A	10,000
32RG18-2315T	White	Incandescent	28	.04A	7,000
32R-2317T	Clear	Neon	125	1/3W	25,000
35R-2317T	Clear	Neon	250	1/3W	25,000
32RG1-2317T	Clear	Incandescent	6	.20A	5,000
32RG3-2317T	Clear	Incandescent	14	.10A	10,000
32RG18-2317T	Clear	Incandescent	28	.04A	7,000

Pressfit Indicator Lights for 1/2 Dia. Mounting Hole

32/35 SERIES

Hi-Hat Lens
Without Bezel
Neon or
Incandescent

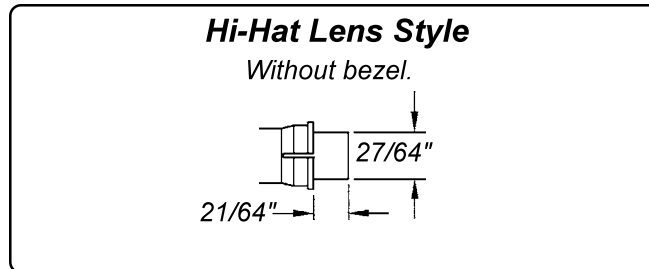

3/16" Tab Terminals
White Housing
6 to 250 Design Volts
PressFit Mounting

Part Number 3/16" Tab Terminals	Lens Color	Lamp Type	Design Volts	Design Watts or Amps	Life (hrs)
32-2511T	Red	Neon	125	1/3W	25,000
35-2511T	Red	Neon	250	1/3W	25,000
32G1-2511T	Red	Incandescent	6	.20A	5,000
32G3-2511T	Red	Incandescent	14	.10A	10,000
32G18-2511T	Red	Incandescent	28	.04A	7,000
32-2512T	Green	Neon	125	1/3W	25,000
35-2512T	Green	Neon	250	1/3W	25,000
32G1-2512T	Green	Incandescent	6	.20A	5,000
32G3-2512T	Green	Incandescent	14	.10A	10,000
32G18-2512T	Green	Incandescent	28	.04A	7,000
32-2513T	Amber	Neon	125	1/3W	25,000
35-2513T	Amber	Neon	250	1/3W	25,000
32G1-2513T	Amber	Incandescent	6	.20A	5,000
32G3-2513T	Amber	Incandescent	14	.10A	10,000
32G18-2513T	Amber	Incandescent	28	.04A	7,000
32-2514T	Blue	Neon	125	1/3W	25,000
35-2514T	Blue	Neon	250	1/3W	25,000
32G1-2514T	Blue	Incandescent	6	.20A	5,000
32G3-2514T	Blue	Incandescent	14	.10A	10,000
32G18-2514T	Blue	Incandescent	28	.04A	7,000
32-2515T	White	Neon	125	1/3W	25,000
35-2515T	White	Neon	250	1/3W	25,000
32G1-2515T	White	Incandescent	6	.20A	5,000
32G3-2515T	White	Incandescent	14	.10A	10,000
32G18-2515T	White	Incandescent	28	.04A	7,000
32-2517T	Clear	Neon	125	1/3W	25,000
35-2517T	Clear	Neon	250	1/3W	25,000
32G1-2517T	Clear	Incandescent	6	.20A	5,000
32G3-2517T	Clear	Incandescent	14	.10A	10,000
32G18-2517T	Clear	Incandescent	28	.04A	7,000

Pressfit Indicator Lights for 1/2 Dia. Mounting Hole

32/35 SERIES

Hi-Hat Lens
Nickel Plated Bezel
Neon or
Incandescent

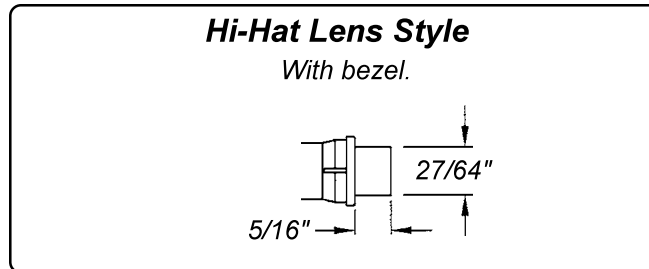

3/16" Tab Terminals
White Housing
6 to 250 Design Volts
PressFit Mounting

Part Number 3/16" Tab Terminals	Lens Color	Lamp Type	Design Volts	Design Watts or Amps	Life (hrs)
32R-2511T	Red	Neon	125	1/3W	25,000
35R-2511T	Red	Neon	250	1/3W	25,000
32RG1-2511T	Red	Incandescent	6	.20A	5,000
32RG3-2511T	Red	Incandescent	14	.10A	10,000
32RG18-2511T	Red	Incandescent	28	.04A	7,000
32R-2512T	Green	Neon	125	1/3W	25,000
35R-2512T	Green	Neon	250	1/3W	25,000
32RG1-2512T	Green	Incandescent	6	.20A	5,000
32RG3-2512T	Green	Incandescent	14	.10A	10,000
32RG18-2512T	Green	Incandescent	28	.04A	7,000
32R-2513T	Amber	Neon	125	1/3W	25,000
35R-2513T	Amber	Neon	250	1/3W	25,000
32RG1-2513T	Amber	Incandescent	6	.20A	5,000
32RG3-2513T	Amber	Incandescent	14	.10A	10,000
32RG18-2513T	Amber	Incandescent	28	.04A	7,000
32R-2514T	Blue	Neon	125	1/3W	25,000
35R-2514T	Blue	Neon	250	1/3W	25,000
32RG1-2514T	Blue	Incandescent	6	.20A	5,000
32RG3-2514T	Blue	Incandescent	14	.10A	10,000
32RG18-2514T	Blue	Incandescent	28	.04A	7,000
32R-2515T	White	Neon	125	1/3W	25,000
35R-2515T	White	Neon	250	1/3W	25,000
32RG1-2515T	White	Incandescent	6	.20A	5,000
32RG3-2515T	White	Incandescent	14	.10A	10,000
32RG18-2515T	White	Incandescent	28	.04A	7,000
32R-2517T	Clear	Neon	125	1/3W	25,000
35R-2517T	Clear	Neon	250	1/3W	25,000
32RG1-2517T	Clear	Incandescent	6	.20A	5,000
32RG3-2517T	Clear	Incandescent	14	.10A	10,000
32RG18-2517T	Clear	Incandescent	28	.04A	7,000

Pressfit Indicator Lights for 1/2 Dia. Mounting Hole

L32/35 SERIES
LED Indicator Lights
White Housing
2 to 24 Design Volts

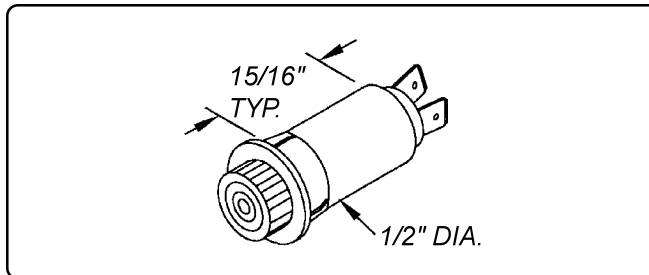

3/16" Tab Terminals
Nickel Plated Bezel
Variety of Lenses
and Colors

Part Number With Flat Cylindrical Lens	Part Number with Flush Lens	Part Number With Hi-Hat Lens	Lens Color	DC Design Volts
L32R-A2-2113T	L32R-A2-2313T	L32R-A2-2513T	Amber	2
L32R-A6-2113T	L32R-A6-2313T	L32R-A6-2513T	Amber	6
L32R-A12-2113T	L32R-A12-2313T	L32R-A12-2513T	Amber	12
L32R-A24-2113T	L32R-A24-2313T	L32R-A24-2513T	Amber	24
L32R-G2-2112T	L32R-G2-2312T	L32R-G2-2512T	Green	2
L32R-G6-2112T	L32R-G6-2312T	L32R-G6-2512T	Green	6
L32R-G12-2112T	L32R-G12-2312T	L32R-G12-2512T	Green	12
L32R-G24-2112T	L32R-G24-2312T	L32R-G24-2512T	Green	24
L32R-R2-2111T	L32R-R2-2311T	L32R-R2-2511T	Red	2
L32R-R6-2111T	L32R-R6-2311T	L32R-R6-2511T	Red	6
L32R-R12-2111T	L32R-R12-2311T	L32R-R12-2511T	Red	12
L32R-R24-2111T	L32R-R24-2311T	L32R-R24-2511T	Red	24
L32R-Y2-2116T	L32R-Y2-2316T	L32R-Y2-2516T	Yellow	2
L32R-Y6-2116T	L32R-Y6-2316T	L32R-Y6-2516T	Yellow	6
L32R-Y12-2116T	L32R-Y12-2316T	L32R-Y12-2516T	Yellow	12
L32R-Y24-2116T	L32R-Y24-2316T	L32R-Y24-2516T	Yellow	24

Polarity Determination - Wire Leads: Red wire lead denotes anode (+); black wire lead denotes cathode (-).
Terminals: One terminal is tin-plated to denote anode (+); unplated terminal refers to cathode (-).

