

Chipsmall Limited consists of a professional team with an average of over 10 year of expertise in the distribution of electronic components. Based in Hongkong, we have already established firm and mutual-benefit business relationships with customers from,Europe,America and south Asia,supplying obsolete and hard-to-find components to meet their specific needs.

With the principle of “Quality Parts,Customers Priority,Honest Operation,and Considerate Service”,our business mainly focus on the distribution of electronic components. Line cards we deal with include Microchip,ALPS,ROHM,Xilinx,Pulse,ON,Everlight and Freescale. Main products comprise IC,Modules,Potentiometer,IC Socket,Relay,Connector.Our parts cover such applications as commercial,industrial, and automotives areas.

We are looking forward to setting up business relationship with you and hope to provide you with the best service and solution. Let us make a better world for our industry!



## Contact us

Tel: +86-755-8981 8866 Fax: +86-755-8427 6832

Email & Skype: info@chipsmall.com Web: www.chipsmall.com

Address: A1208, Overseas Decoration Building, #122 Zhenhua RD., Futian, Shenzhen, China

# SERIES 320 SWITCHES

## TACT SWITCHES



E-SWITCH®

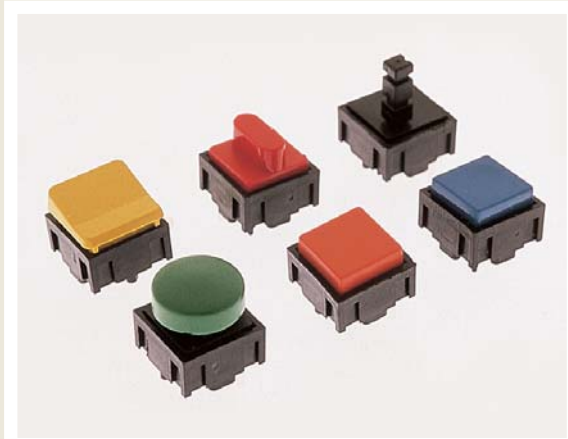

### FEATURES & BENEFITS

- ▶ Multiple cap & color options
- ▶ High reliability dome technology
- ▶ Excellent tactile feedback

### APPLICATIONS/MARKETS

- ▶ Telecommunications
- ▶ Networking
- ▶ Computers/servers
- ▶ Performance audio
- ▶ Instrumentation
- ▶ Low power on/off designs
- ▶ External hard drives and modems

### SPECIFICATIONS

Contact Rating:	25mA @ 50 VDC
Life Expectancy:	1,000,000 cycles min.
Contact Resistance:	50mΩ, max. initial @ 2-4 VDC, 100mA
Insulation Resistance:	1,000MΩ min.
Dielectric Strength:	>500 VAC rms at sea level
Actuation Force:	135 ± 50 gf
Operating Temperature:	-20°C to 70°C
Travel:	.6mm Typ.

### MATERIALS

Housing:	Nylon 4/6
Cover/Cap:	ABS or Polycarbonate
Dome Contact:	Gold over stainless steel
Terminals/Contacts:	Silver plated copper alloy



### HOW TO ORDER

CAP STYLE	CIRCUIT	CAP COLOR	ADDITIONAL CAP (Fits over cap styles 320.02 & 320.03 only.)	CAP COLOR
<input type="checkbox"/> <input type="checkbox"/> <input type="checkbox"/> <input type="checkbox"/> <input type="checkbox"/> <input type="checkbox"/>	<input type="checkbox"/> <input type="checkbox"/> <input type="checkbox"/>	<input type="checkbox"/> <input type="checkbox"/> <input type="checkbox"/>	<input type="checkbox"/> <input type="checkbox"/> <input type="checkbox"/> <input type="checkbox"/> <input type="checkbox"/> <input type="checkbox"/> <input type="checkbox"/> <input type="checkbox"/>	<input type="checkbox"/> <input type="checkbox"/> <input type="checkbox"/>
320 320.01 320.02 320.03 320.04 320.22 320.08* 320.09* 320.094* 320.2 320.21	E11 (SPST)	BLK = Black GRY = Grey YEL = Yellow BLU = Blue GRN = Green WHT = White RED = Red	See Cap Section	



### Example Ordering Number

320.08-E1-1-YEL

\*Note: Assembled using the 320.02 plungered cap.

Specifications subject to change without notice.

## 320

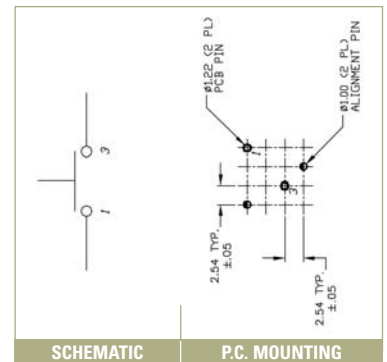
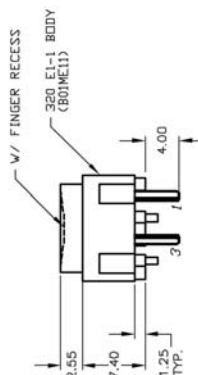
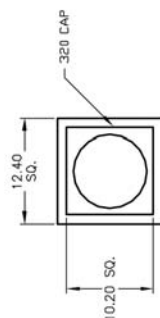

# SERIES 320 SWITCHES

## TACT SWITCHES

TACT SWITCHES

### 320.01

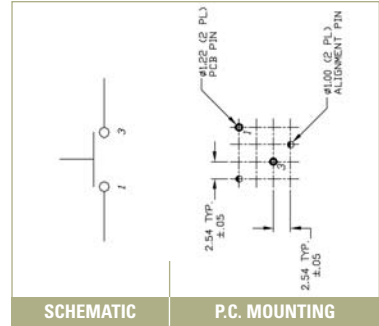
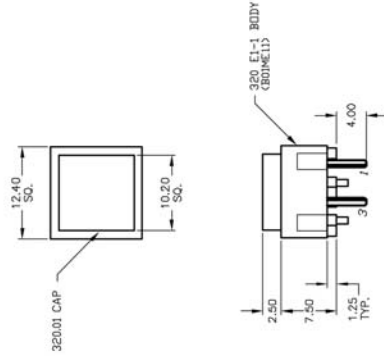

NAVIGATION SWITCHES

PUSHBUTTON SWITCHES

TOGGLE SWITCHES

### 320.02

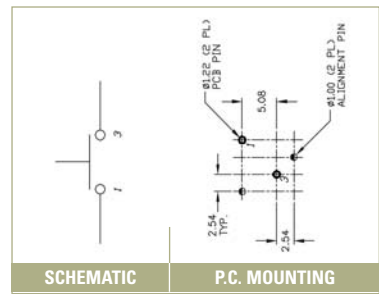
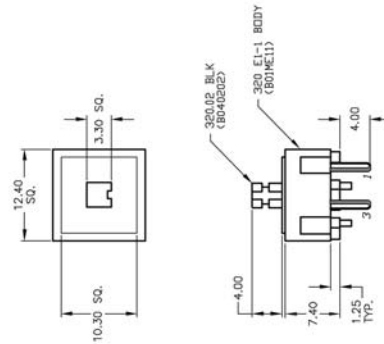

ROCKER SWITCHES

SLIDE SWITCHES

### 320.03

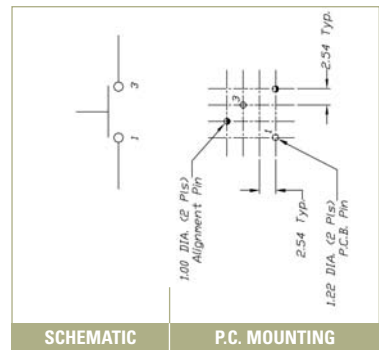
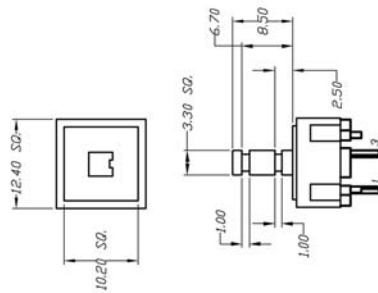

SNAP-ACTION SWITCHES

DIP SWITCHES

KEYLOCK SWITCHES

### 320.04

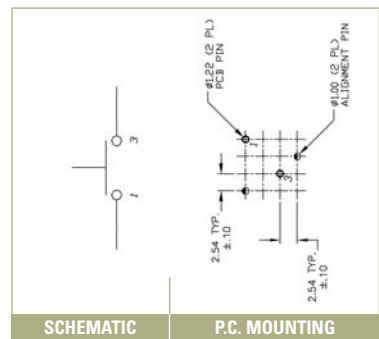
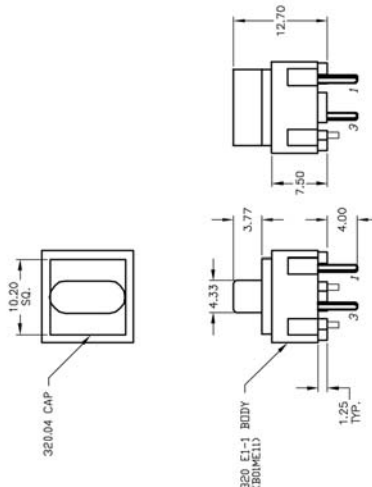

ROTARY SWITCHES

DETECTOR SWITCHES

CAP OPTIONS



### 320.22

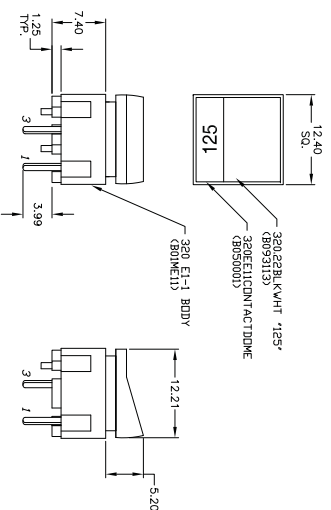

#### SCHEMATIC

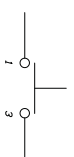

#### P.C. MOUNTING

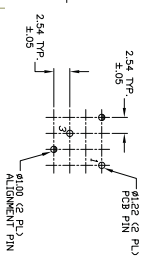

### 320.2

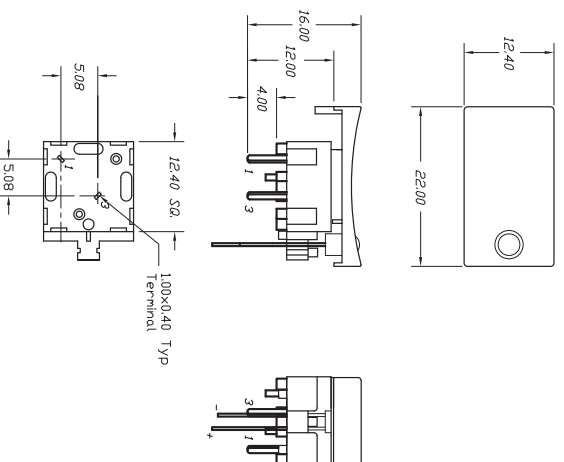

#### SCHEMATIC

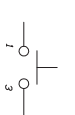

#### P.C. MOUNTING

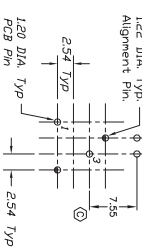

### 320.21

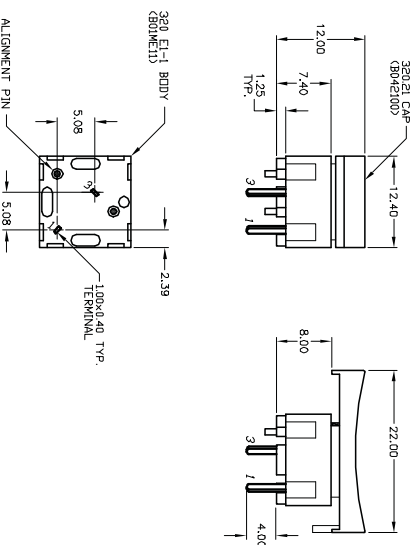

#### SCHEMATIC

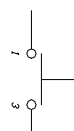

#### P.C. MOUNTING

