



Chipsmall Limited consists of a professional team with an average of over 10 year of expertise in the distribution of electronic components. Based in Hongkong, we have already established firm and mutual-benefit business relationships with customers from,Europe,America and south Asia,supplying obsolete and hard-to-find components to meet their specific needs.

With the principle of "Quality Parts,Customers Priority,Honest Operation,and Considerate Service",our business mainly focus on the distribution of electronic components. Line cards we deal with include Microchip,ALPS,ROHM,Xilinx,Pulse,ON,Everlight and Freescale. Main products comprise IC,Modules,Potentiometer,IC Socket,Relay,Connector.Our parts cover such applications as commercial,industrial, and automotives areas.

We are looking forward to setting up business relationship with you and hope to provide you with the best service and solution. Let us make a better world for our industry!



Contact us

Tel: +86-755-8981 8866 Fax: +86-755-8427 6832

Email & Skype: info@chipsmall.com Web: www.chipsmall.com

Address: A1208, Overseas Decoration Building, #122 Zhenhua RD., Futian, Shenzhen, China



Plug - SP-H 2,5/ 1-L - 3210787

Please be informed that the data shown in this PDF Document is generated from our Online Catalog. Please find the complete data in the user's documentation. Our General Terms of Use for Downloads are valid (<http://phoenixcontact.com/download>)



Plug, nom. voltage: 500 V, nominal current: 24 A, connection method: Spring-cage connection, Plug connection, number of connections: 1, number of positions: 1, cross section: 0.08 mm² - 4 mm², AWG: 28 - 12, width: 5.2 mm, height: 39 mm, color: gray

Product Description

Connector element left, left housing without engagement pin, right opened without cover

Why buy this product

- ✓ Cable housing can be snapped on to the plugs, see figure below
- ✓ The plug with spring-cage connection is assembled directly on site by snapping together single-position plug elements
- ✓ The ST-COMBI plugs for self-assembly provide solutions that users can implement themselves
- ✓ Tested for railway applications



Key Commercial Data

Packing unit	50 STK
GTIN	 4 046356 411776
GTIN	4046356411776

Technical data

General

Number of positions	1
Number of levels	1
Number of connections	1
Potentials	1
Nominal cross section	2.5 mm ²
Color	gray
Insulating material	PA
Flammability rating according to UL 94	V0
Area of application	Railway industry
	Machine building

Plug - SP-H 2,5/ 1-L - 3210787

Technical data

General

	Plant engineering
Maximum load current	24 A (with a 2.5 mm ² conductor cross section)
Rated surge voltage	6 kV
Degree of pollution	3
Overvoltage category	III
Insulating material group	I
Maximum power dissipation for nominal condition	0.77 W
Maximum load current	24 A (with 4 mm ² conductor cross section)
Nominal current I _N	24 A
Nominal voltage U _N	500 V
Relative insulation material temperature index (Elec., UL 746 B)	130 °C
Temperature index of insulation material (DIN EN 60216-1 (VDE 0304-21))	130 °C
Static insulating material application in cold	-60 °C
Behavior in fire for rail vehicles (DIN 5510-2)	Test passed
Flame test method (DIN EN 60695-11-10)	V0
Oxygen index (DIN EN ISO 4589-2)	>32 %
NF F16-101, NF F10-102 Class I	2
NF F16-101, NF F10-102 Class F	2
Surface flammability NFPA 130 (ASTM E 162)	passed
Specific optical density of smoke NFPA 130 (ASTM E 662)	passed
Smoke gas toxicity NFPA 130 (SMP 800C)	passed
Calorimetric heat release NFPA 130 (ASTM E 1354)	28 MJ/kg
Fire protection for rail vehicles (DIN EN 45545-2) R22	HL 1 - HL 3
Fire protection for rail vehicles (DIN EN 45545-2) R23	HL 1 - HL 3
Fire protection for rail vehicles (DIN EN 45545-2) R24	HL 1 - HL 3
Fire protection for rail vehicles (DIN EN 45545-2) R26	HL 1 - HL 3

Dimensions

Width	5.2 mm
Length	15.8 mm
Height	39 mm
	24 mm
Pitch	5.2 mm

Connection data

Connection method	Spring-cage connection
Connection in acc. with standard	IEC 61984
Conductor cross section solid min.	0.08 mm ²
Conductor cross section solid max.	4 mm ²
Conductor cross section AWG min.	28
Conductor cross section AWG max.	12

Plug - SP-H 2,5/ 1-L - 3210787

Technical data

Connection data

Conductor cross section flexible min.	0.08 mm ²
Conductor cross section flexible max.	2.5 mm ²
Min. AWG conductor cross section, flexible	28
Max. AWG conductor cross section, flexible	14
Conductor cross section flexible, with ferrule without plastic sleeve min.	0.14 mm ²
Conductor cross section flexible, with ferrule without plastic sleeve max.	2.5 mm ²
Conductor cross section flexible, with ferrule with plastic sleeve min.	0.14 mm ²
Conductor cross section flexible, with ferrule with plastic sleeve max.	2.5 mm ²
2 conductors with same cross section, stranded, TWIN ferrules with plastic sleeve, max.	0.5 mm ²
Stripping length	8 mm ... 10 mm
Internal cylindrical gage	A3
Connection method	Plug connection

Standards and Regulations

Connection in acc. with standard	CSA
	IEC 61984
Flammability rating according to UL 94	V0
Fire protection for rail vehicles (DIN EN 45545-2) R22	HL 1 - HL 3 HL 1 - HL 3 HL 1 - HL 3 HL 1 - HL 3
Fire protection for rail vehicles (DIN EN 45545-2) R23	HL 1 - HL 3 HL 1 - HL 3 HL 1 - HL 3 HL 1 - HL 3
Fire protection for rail vehicles (DIN EN 45545-2) R24	HL 1 - HL 3 HL 1 - HL 3 HL 1 - HL 3 HL 1 - HL 3
Fire protection for rail vehicles (DIN EN 45545-2) R26	HL 1 - HL 3 HL 1 - HL 3 HL 1 - HL 3 HL 1 - HL 3

Environmental Product Compliance

China RoHS	Environmentally friendly use period: unlimited = EFUP-e
	No hazardous substances above threshold values

Drawings

Circuit diagram



Diagram

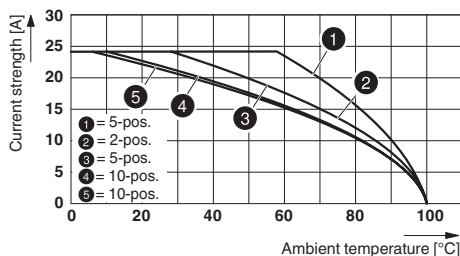

Plug - SP-H 2,5/ 1-L - 3210787

Schematic diagram

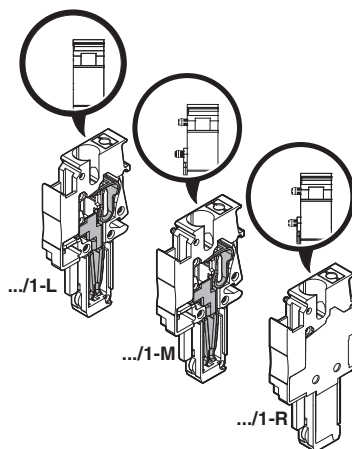

Approvals

Approvals

Approvals

CSA / UL Recognized / cUL Recognized / EAC / VDE report with production monitoring / IECCE CB Scheme / cULus Recognized

Ex Approvals

Approval details

CSA		http://www.csagroup.org/services-industries/product-listing/	13631
		B	C
Nominal voltage UN		300 V	300 V
Nominal current IN		20 A	20 A
mm ² /AWG/kcmil		26-12	26-12

UL Recognized		http://database.ul.com/cgi-bin/XYV/template/LISEXT/1FRAME/index.htm	FILE E 60425
		B	C
Nominal voltage UN		300 V	300 V
Nominal current IN		20 A	20 A
mm ² /AWG/kcmil		26-12	26-12

Plug - SP-H 2,5/ 1-L - 3210787

Approvals

cUL Recognized		http://database.ul.com/cgi-bin/XYV/template/LISEXT/1FRAME/index.htm	FILE E 60425
	B	C	
Nominal voltage UN	300 V	300 V	
Nominal current IN	20 A	20 A	
mm ² /AWG/kcmil	26-12	26-12	

EAC		EAC-Zulassung
-----	-----------------------------------------------------------------------------------	---------------

VDE report with production monitoring		http://www2.vde.com/de/Institut/Online-Service/VDE-gepruefteProdukte/Seiten/Online-Suche.aspx	40019518
Nominal voltage UN	500 V		
mm ² /AWG/kcmil	0.2-4		

IECEE CB Scheme		http://www.iecee.org/	DE1-57873_B1
Nominal voltage UN	500 V		
mm ² /AWG/kcmil	0.2-4		

cULus Recognized		http://database.ul.com/cgi-bin/XYV/template/LISEXT/1FRAME/index.htm
------------------	-------------------------------------------------------------------------------------	-------------------------------------------------------------------------------------------------------------------------------------------------------

Phoenix Contact 2018 © - all rights reserved
<http://www.phoenixcontact.com>

PHOENIX CONTACT GmbH & Co. KG
 Flachsmarktstr. 8
 32825 Blomberg
 Germany
 Tel. +49 5235 300
 Fax +49 5235 3 41200
<http://www.phoenixcontact.com>