



Chipsmall Limited consists of a professional team with an average of over 10 year of expertise in the distribution of electronic components. Based in Hongkong, we have already established firm and mutual-benefit business relationships with customers from,Europe,America and south Asia,supplying obsolete and hard-to-find components to meet their specific needs.

With the principle of “Quality Parts,Customers Priority,Honest Operation,and Considerate Service”,our business mainly focus on the distribution of electronic components. Line cards we deal with include Microchip,ALPS,ROHM,Xilinx,Pulse,ON,Everlight and Freescale. Main products comprise IC,Modules,Potentiometer,IC Socket,Relay,Connector.Our parts cover such applications as commercial,industrial, and automotives areas.

We are looking forward to setting up business relationship with you and hope to provide you with the best service and solution. Let us make a better world for our industry!



Contact us

Tel: +86-755-8981 8866 Fax: +86-755-8427 6832

Email & Skype: info@chipsmall.com Web: www.chipsmall.com

Address: A1208, Overseas Decoration Building, #122 Zhenhua RD., Futian, Shenzhen, China





324, 325, 326, 327, 328, 332 & 333 SERIES CAPS

1/2" SQUARE

CAP PART NO.	COLOR	FIG
324-0071	RED	1
324-0072	GREEN	1
324-0073	YELLOW	1
324-0075	WHITE	1

5/8" x 3/4" RECTANGULAR

CAP PART NO.	COLOR	FIG
333-0071*	RED	2
333-0072*	GREEN	2
333-0073*	YELLOW	2
333-0075*	WHITE	2

* Has Fingertip Grips

5/8" SQUARE

CAP PART NO.	COLOR	FIG
325-0071	RED	3
325-0072	GREEN	3
325-0073	YELLOW	3
325-0075	WHITE	3

3/4" SQUARE

CAP PART NO.	COLOR	FIG
327-0071	RED	4
327-0072	GREEN	4
327-0073	YELLOW	4
327-0075	WHITE	4

5/8" SQUARE LED

CAP PART NO.	LED/CAP	FIG
332-0010	RED/BLACK	5
332-0015	RED/WHITE	5
332-0020	GREEN/BLACK	5
332-0030	YELLOW/BLACK	5

3/4" x 1" RECTANGULAR

CAP PART NO.	COLOR	FIG
328-0071	RED	6
328-0072	GREEN	6
328-0073	YELLOW	6
328-0075	WHITE	6

5/8" x 3/4" RECTANGULAR

CAP PART NO.	COLOR	FIG
326-0071	RED	7
326-0072	GREEN	7
326-0073	YELLOW	7
326-0075	WHITE	7

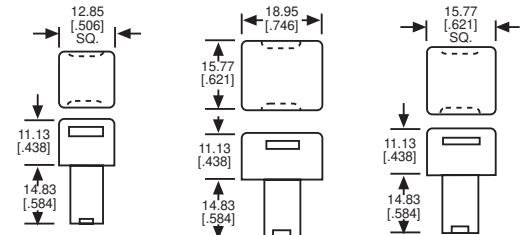

Fig 1

Fig 2

Fig 3

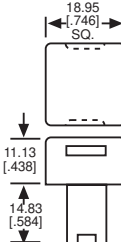

Fig 4

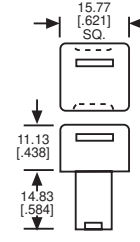

Fig 5

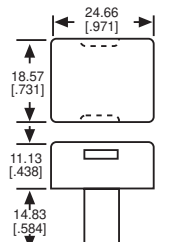

Fig 6

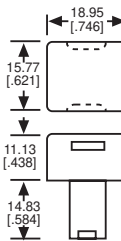

Fig 7

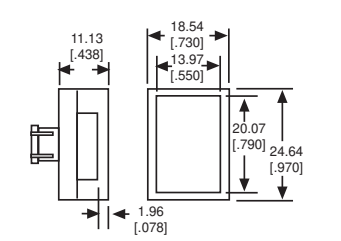

Fig 8

Please contact factory for legend information available on Figures 1 thru 8.

329 & 330 SERIES CAP KITS

3/4" X 1" LEGEND KITS - SINGLE LAMP

KIT PART NO.	LENS/FILTER COLOR	FIG
329-0701-030	RED, GREEN, AMBER, BLUE/NONE	8
329-0701-037	CLEAR/NONE	8
329-0701-537	CLEAR/RED, GREEN, AMBER, BLUE	8

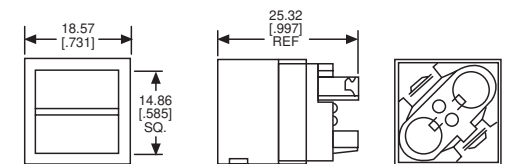

Fig 9

3/4" LEGEND KITS - DUAL LAMP

KIT PART NO.	LENS/FILTER COLOR	FIG
330-0100-100	RED, GREEN, AMBER, BLUE, WHITE/NONE	9
330-0255-155	(2) WHITE/RED, GREEN, AMBER, BLUE	9

Legends provided by Dialight Stocking Distributors

Material: Cap, High Temperature Scratch-Resistant Plastic

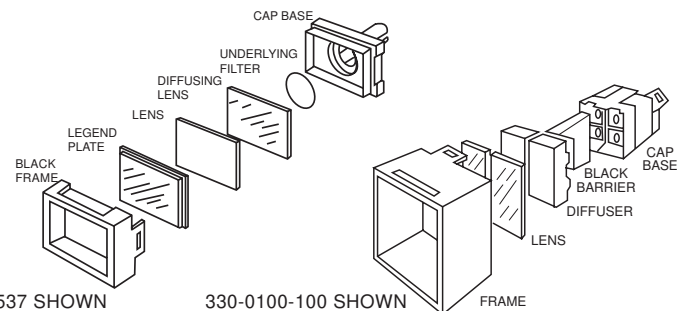

329-0701-537 SHOWN

330-0100-100 SHOWN

