



Chipsmall Limited consists of a professional team with an average of over 10 year of expertise in the distribution of electronic components. Based in Hongkong, we have already established firm and mutual-benefit business relationships with customers from,Europe,America and south Asia,supplying obsolete and hard-to-find components to meet their specific needs.

With the principle of “Quality Parts,Customers Priority,Honest Operation,and Considerate Service”,our business mainly focus on the distribution of electronic components. Line cards we deal with include Microchip,ALPS,ROHM,Xilinx,Pulse,ON,Everlight and Freescale. Main products comprise IC,Modules,Potentiometer,IC Socket,Relay,Connector.Our parts cover such applications as commercial,industrial, and automotives areas.

We are looking forward to setting up business relationship with you and hope to provide you with the best service and solution. Let us make a better world for our industry!



Contact us

Tel: +86-755-8981 8866 Fax: +86-755-8427 6832

Email & Skype: info@chipsmall.com Web: www.chipsmall.com

Address: A1208, Overseas Decoration Building, #122 Zhenhua RD., Futian, Shenzhen, China





BOARD LEVEL COOLING – Square Skived Fin

Square skived fin is a series of square skived fin board level heat sinks designed to cool BGA and FPGA devices. Representative image only.

ORDERING INFORMATION

Part Number	Device Type
342940	BGA, FPGA
342941	BGA, FPGA
342942	BGA, FPGA
342943	BGA, FPGA
342945	BGA, FPGA
342946	BGA, FPGA
342947	BGA, FPGA
342948	BGA, FPGA
342949	BGA, FPGA
342950	BGA, FPGA

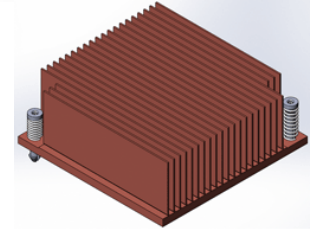
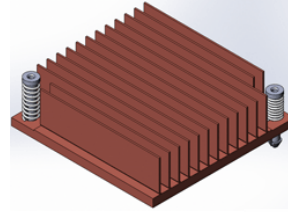

HEAT SINK DETAILS

Property	Details
Material	Copper
Finish	AavSHIELD 3C
Device Attachment Options	Push Pin

Property	Details
Thermal Interface Material	Laird TPCM 585
Heat Sink Mounting Direction	Horizontal

MECHANICAL & PERFORMANCE

Drawing dimensions are shown in mm, (in)

Part Number	"T" Dim	"H" Dim	"W" Dim	"L" Dim
342940	2.80 (0.110)	14.00	38.50	37.58
342941	2.80 (0.110)	13.50	40.00	40.50
342942	2.80 (0.110)	22.50	45.00	44.00
342943	2.80 (0.110)	14.00	50.00	50.00
342945	2.80 (0.110)	14.00	60.00	60.00
342946	2.80 (0.110)	22.00	60.00	60.00
342947	2.80 (0.110)	11.00	57.90	59.00
342948	2.80 (0.110)	14.00	70.00	69.00
342949	2.30 (0.091)	12.00	80.00	80.00
342950	2.30 (0.091)	10.00	90.00	90.00

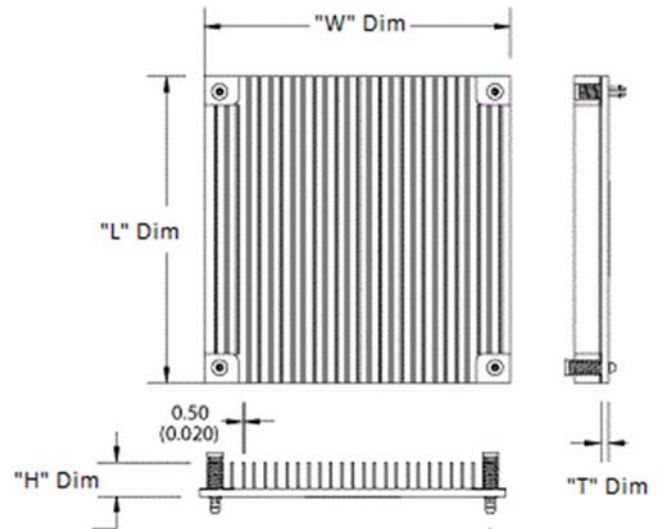

Part Number: 342940

Mounting Details:

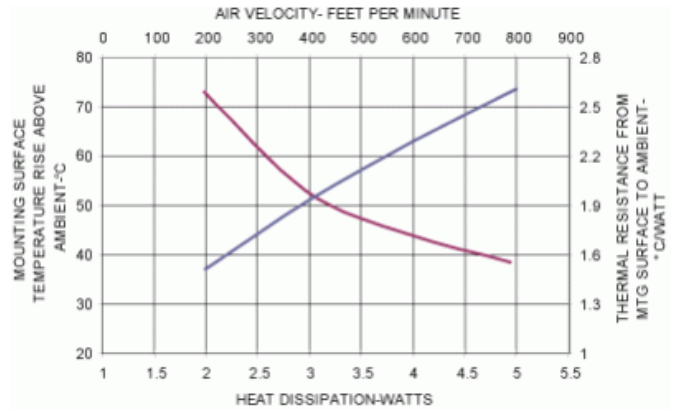
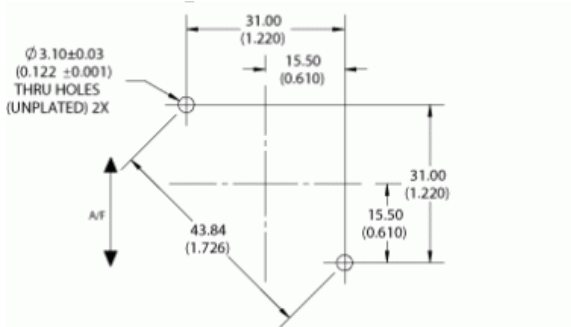

Part Number: 342941

Mounting Details:

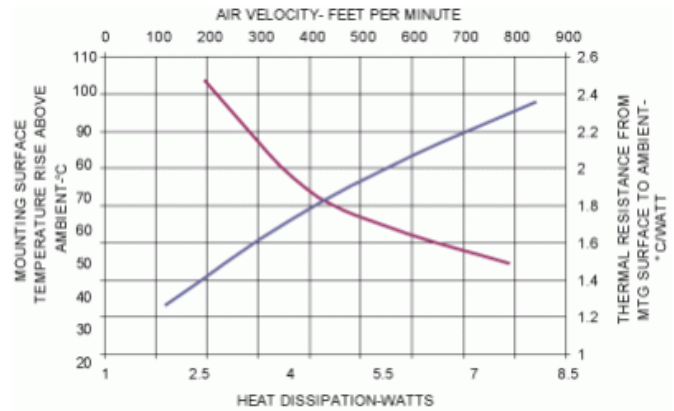
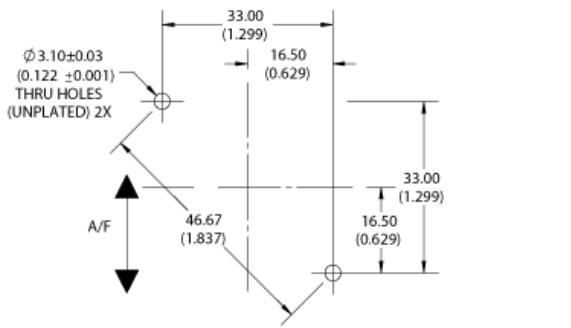

Part Number: 342942

Mounting Details:

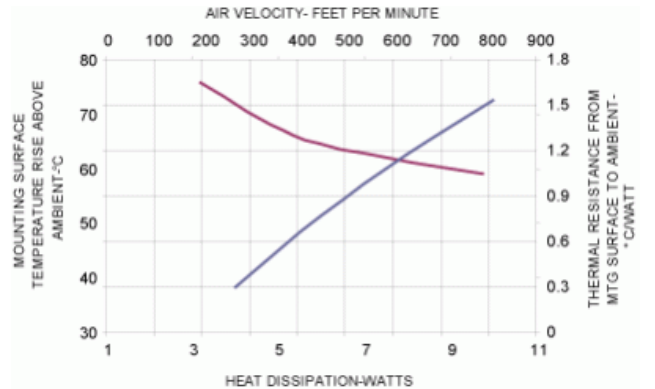
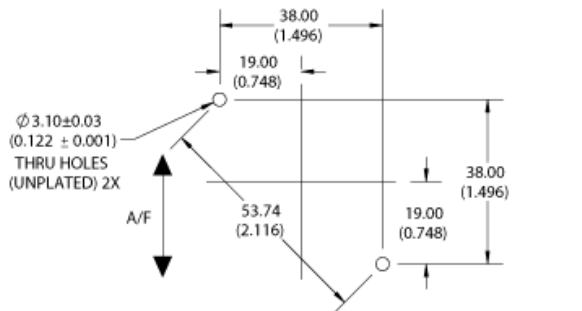

Board Level Cooling – Square Skived Fin

Part Number: 342943

Mounting Details:

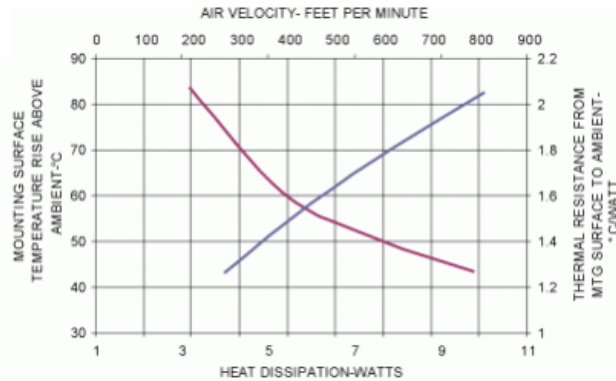
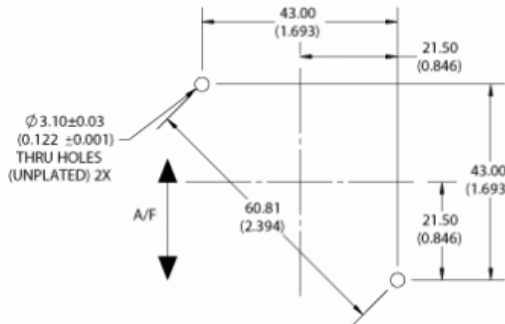

Part Number: 342945

Mounting Details:

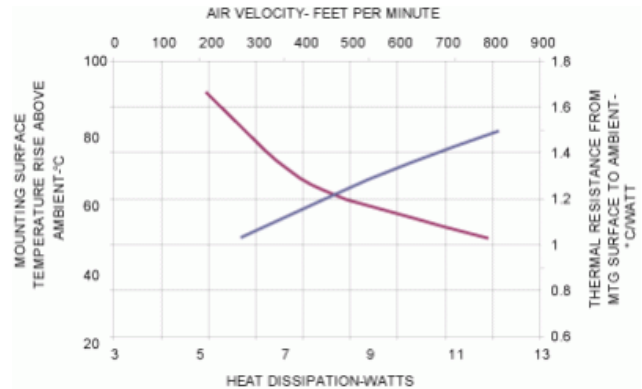
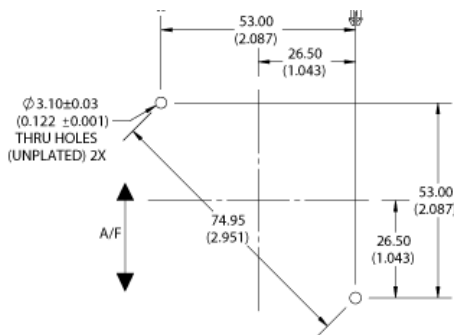

Part Number: 342946

Mounting Details:

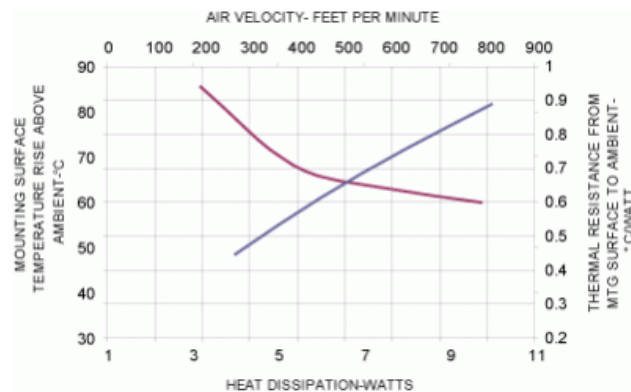
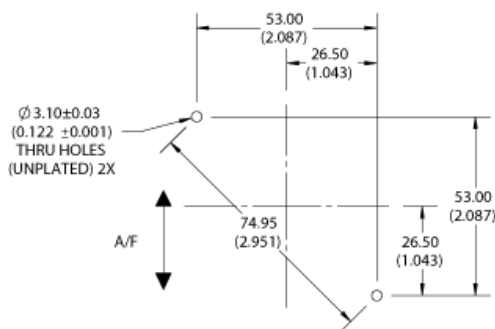

Part Number: 342947

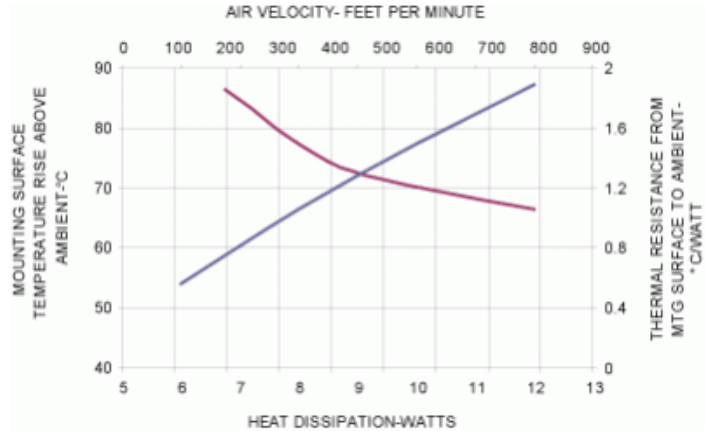
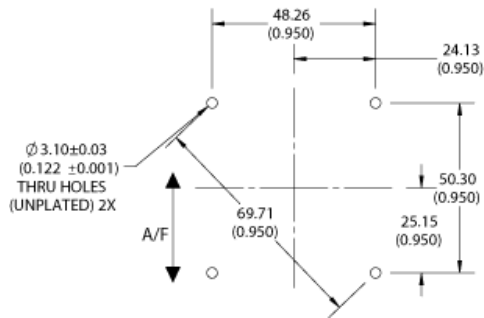

Part Number: 342948

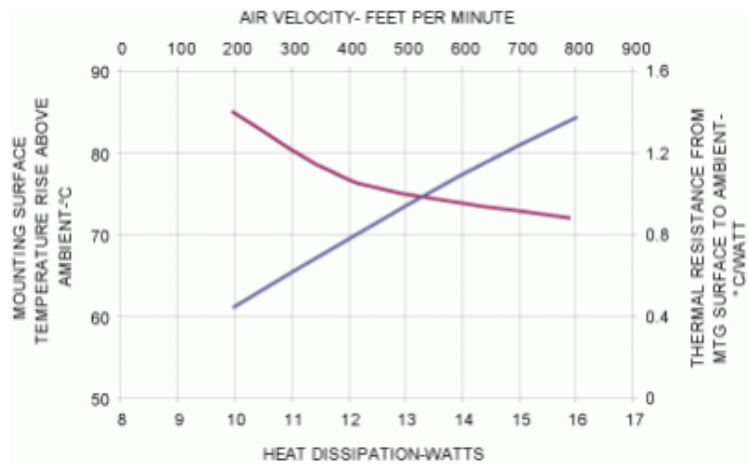
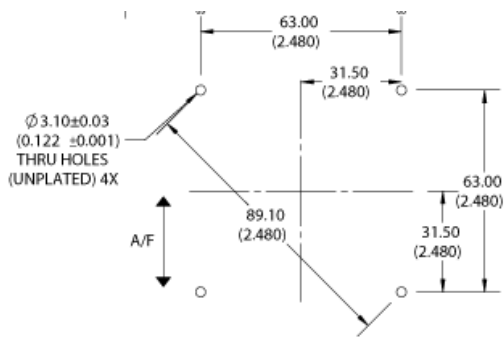

Part Number: 342949

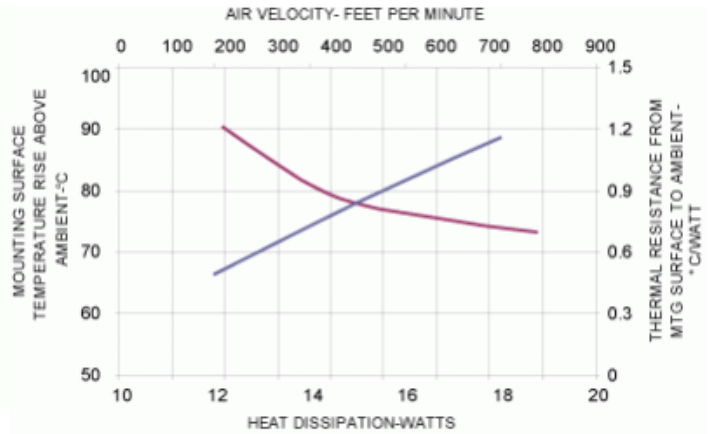
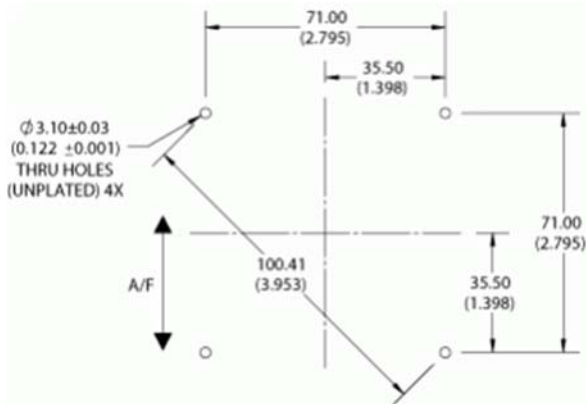

Part Number: 342950

