



Chipsmall Limited consists of a professional team with an average of over 10 year of expertise in the distribution of electronic components. Based in Hongkong, we have already established firm and mutual-benefit business relationships with customers from,Europe,America and south Asia,supplying obsolete and hard-to-find components to meet their specific needs.

With the principle of “Quality Parts,Customers Priority,Honest Operation,and Considerate Service”,our business mainly focus on the distribution of electronic components. Line cards we deal with include Microchip,ALPS,ROHM,Xilinx,Pulse,ON,Everlight and Freescale. Main products comprise IC,Modules,Potentiometer,IC Socket,Relay,Connector.Our parts cover such applications as commercial,industrial, and automotives areas.

We are looking forward to setting up business relationship with you and hope to provide you with the best service and solution. Let us make a better world for our industry!



Contact us

Tel: +86-755-8981 8866 Fax: +86-755-8427 6832

Email & Skype: info@chipsmall.com Web: www.chipsmall.com

Address: A1208, Overseas Decoration Building, #122 Zhenhua RD., Futian, Shenzhen, China



LOC	DIST	REVISIONS						
		P	LTR	DESCRIPTION	ECN	DATE	DWN	APVD
J	---		0	RELEASED	FJ00-0400-97	4. APR. '97	M. S	M. S
			A	REVISED	FJ00-0952-97	26 JUN '97	あさ	あさ

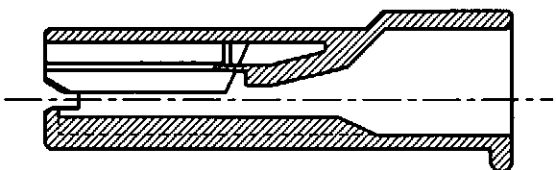
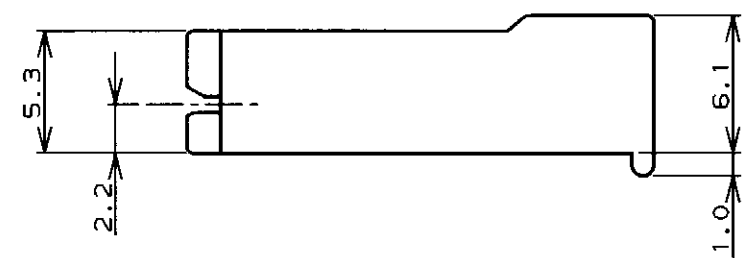
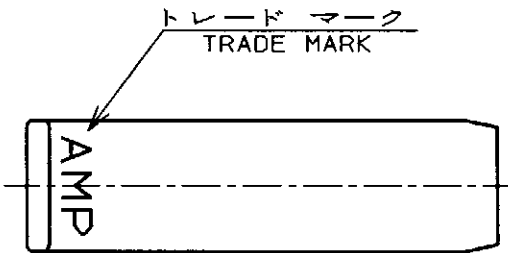
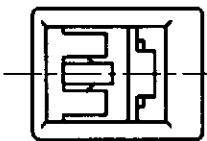
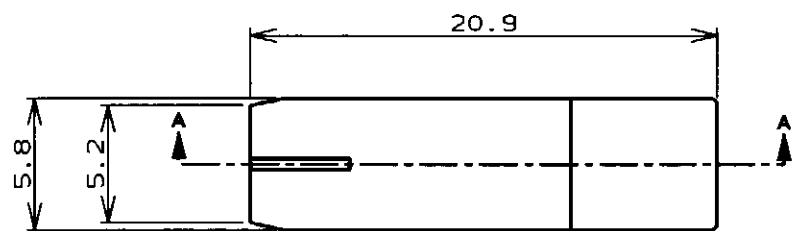
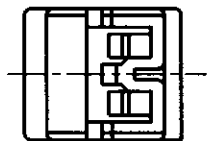

断面 "A" - "A" SECT.

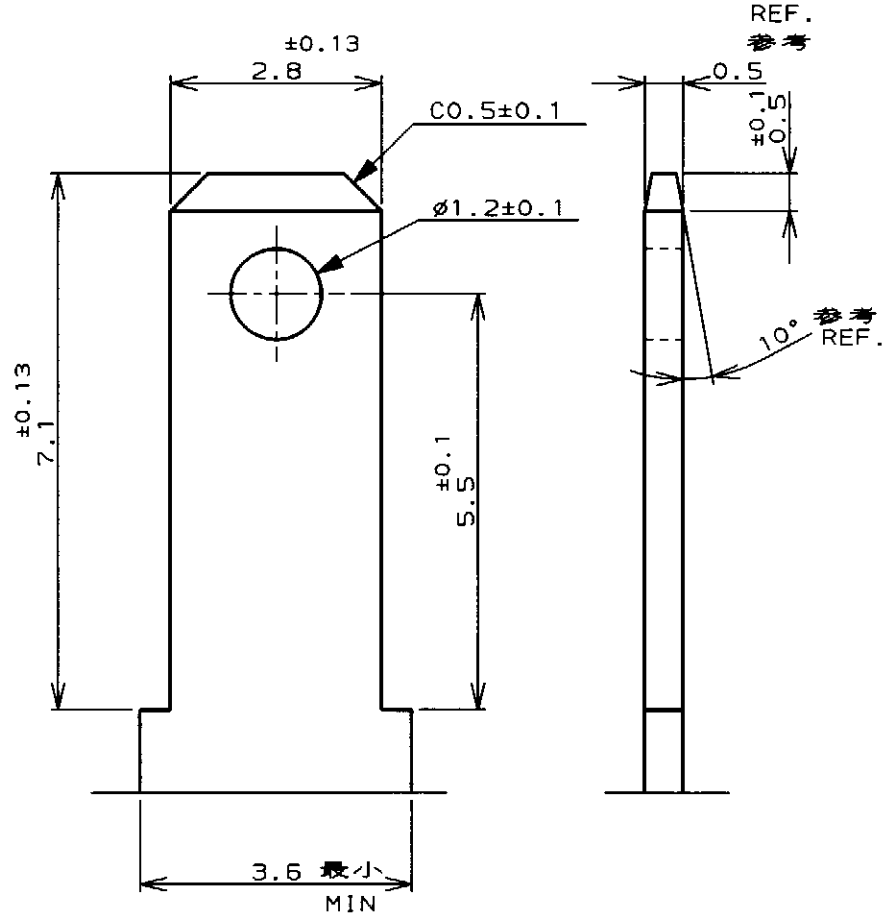

推奨タブ図 APPLICABLE TAB DIMENSIONS

自然色 (NATURAL)	353251-1
色調 (COLOR)	型番 (P/N)

<p>THIS DRAWING IS A CONTROLLED DOCUMENT FOR AMP INCORPORATED. IT IS SUBJECT TO CHANGE AND THE CONTROLLING ENGINEERING ORGANIZATION SHOULD BE CONTACTED FOR THE LATEST REVISION.</p>		<p>OWN: M. SUZUKI 4. APR. '97 CHK: M. SHINDO 4. APR. '97 APVD: M. SHINDO 4. APR. '97</p>		<p>WIRE RANGE: 適合電線断面積 INSULATION DIA: 被覆外径</p>	
<p>DIMENSIONS: 単位: 概 mm</p>		<p>TOLERANCES UNLESS OTHERWISE SPECIFIED</p> <p>一般公差: 10% : ±0.2, 30% : ±0.25, 100% : ±0.3, ANGLE : ±0.3°</p>		<p>AMP 日本アール・エム・シー株式会社 Kawasaki, Japan</p>	
<p>MATERIAL: 6/6ナイロン (UL94V-0) / 6/6 NYLON</p>		<p>FINISH: 仕上</p>		<p>NAME: 110 シリーズ ポジティブ ロック EX-III 1極 ハウジング 110 SERIES POSITIVE LOCK EX-III 1Pos. HOUSING</p>	
<p>PRODUCT SPEC: 108-5530</p>		<p>APPLICATION SPEC: 114-5229</p>		<p>SIZE: A3 CAGE CODE: 00779 DRAWING NO: 353251</p>	
<p>CUSTOMER DRAWING</p>		<p>SCALE: 尺度</p>		<p>SHEET: 1 OF 1 REV: A</p>	