



Chipsmall Limited consists of a professional team with an average of over 10 year of expertise in the distribution of electronic components. Based in Hongkong, we have already established firm and mutual-benefit business relationships with customers from,Europe,America and south Asia,supplying obsolete and hard-to-find components to meet their specific needs.

With the principle of "Quality Parts,Customers Priority,Honest Operation,and Considerate Service",our business mainly focus on the distribution of electronic components. Line cards we deal with include Microchip,ALPS,ROHM,Xilinx,Pulse,ON,Everlight and Freescale. Main products comprise IC,Modules,Potentiometer,IC Socket,Relay,Connector.Our parts cover such applications as commercial,industrial, and automotives areas.

We are looking forward to setting up business relationship with you and hope to provide you with the best service and solution. Let us make a better world for our industry!



Contact us

Tel: +86-755-8981 8866 Fax: +86-755-8427 6832

Email & Skype: info@chipsmall.com Web: www.chipsmall.com

Address: A1208, Overseas Decoration Building, #122 Zhenhua RD., Futian, Shenzhen, China



inspired LED **Micro-Lock Tiger Paw[®] Connector**

Inspired LED's patented solderless **Tiger Paw[®] Connectors** are the perfect solution for in-field LED system design and customization. These innovative accessories pair with LED flex strips for quick, convenient installation. Now, creating the perfect low-voltage lighting system is easier than ever, thanks to Inspired LED!

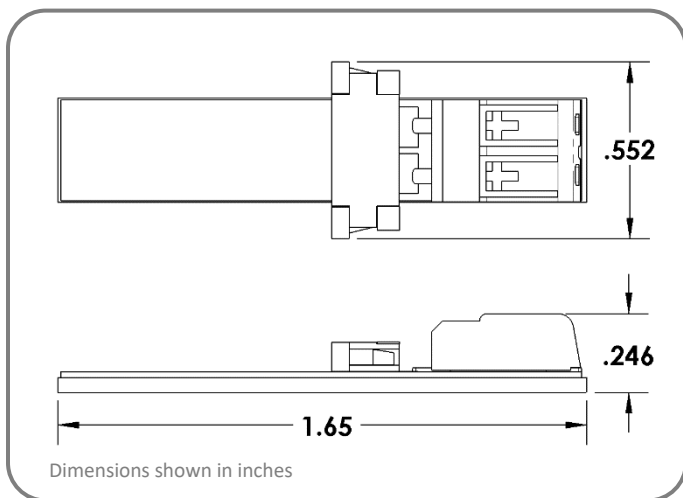
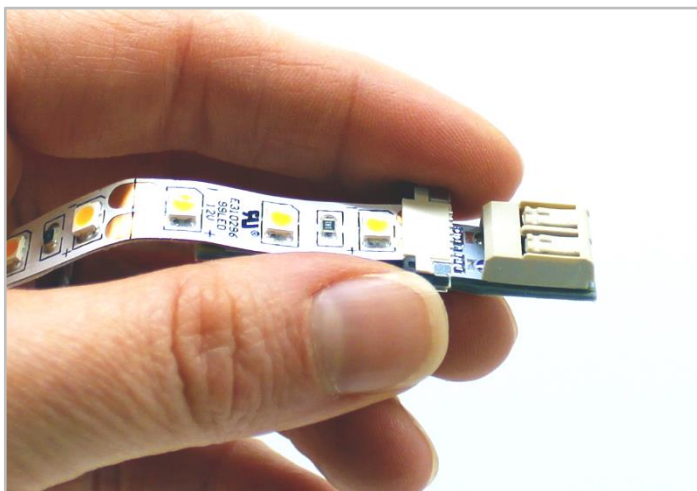

Product Specifications: SKU# 3613

- Solderless termination of 8mm LED flex strips to 16-22 AWG solid cable
- Max Load- 5 AMPs • Net Wt. 2g • VHB adhesive backing included
- Industry proven locking system meets shock and vibration requirements for IEC 60068-2-27
- U.S. Patent No. 8,714,772

Instructions:

- 1** Use scissors to cut LED strip to length along copper solder pads **ONLY** (located ever 3 LEDs).



- 2** Take hold of black sliding latch and pull outward to open.

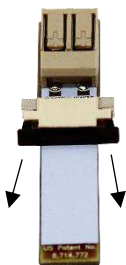

- 3** Peel back adhesive lining on LED strip about 1/2 inch.

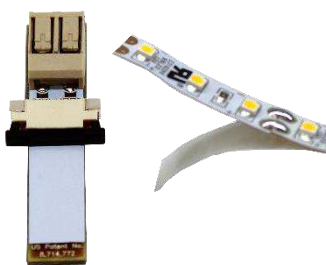

- 4** Insert flex strip into gap between black sliding latch and beige bridge piece.



- 5** Make sure LED strip is centered and fully inserted before sliding black latch firmly closed and pressing on adhesive.

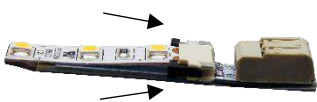

- 6** Strip 16-22 AWG solid cable back about 1/4 inch, taking note of positive and negative polarity.

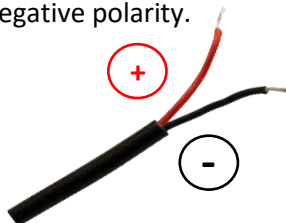

- 7** Match polarity of wires to polarity of LEDs as marked with +/- signs along the flex strip, then firmly insert wires into micro lock.



- 8** Ensure wires are secure and connect to Class 2 DC power, then remove remaining adhesive lining to install.

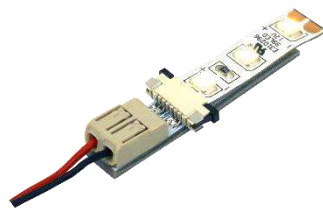

Troubleshooting: If LEDs are flickering, double check connection to be sure flex is fully inserted and secured, if no lights turn on check to be sure polarities are properly matched

