



Chipsmall Limited consists of a professional team with an average of over 10 year of expertise in the distribution of electronic components. Based in Hongkong, we have already established firm and mutual-benefit business relationships with customers from,Europe,America and south Asia,supplying obsolete and hard-to-find components to meet their specific needs.

With the principle of "Quality Parts,Customers Priority,Honest Operation,and Considerate Service",our business mainly focus on the distribution of electronic components. Line cards we deal with include Microchip,ALPS,ROHM,Xilinx,Pulse,ON,Everlight and Freescale. Main products comprise IC,Modules,Potentiometer,IC Socket,Relay,Connector.Our parts cover such applications as commercial,industrial, and automotives areas.

We are looking forward to setting up business relationship with you and hope to provide you with the best service and solution. Let us make a better world for our industry!



Contact us

Tel: +86-755-8981 8866 Fax: +86-755-8427 6832

Email & Skype: info@chipsmall.com Web: www.chipsmall.com

Address: A1208, Overseas Decoration Building, #122 Zhenhua RD., Futian, Shenzhen, China



THESE DRAWINGS ARE THE PROPERTY OF QUALTEK ELECTRONICS AND NOT TO BE REPRODUCED FOR OR COMMUNICATED TO A THIRD PARTY WITHOUT THE EXPRESS WRITTEN PERMISSION OF AN OFFICER OF QUALTEK ELECTRONICS.

REVISION			
REV.	DESCRIPTION	DATE	APPROVED

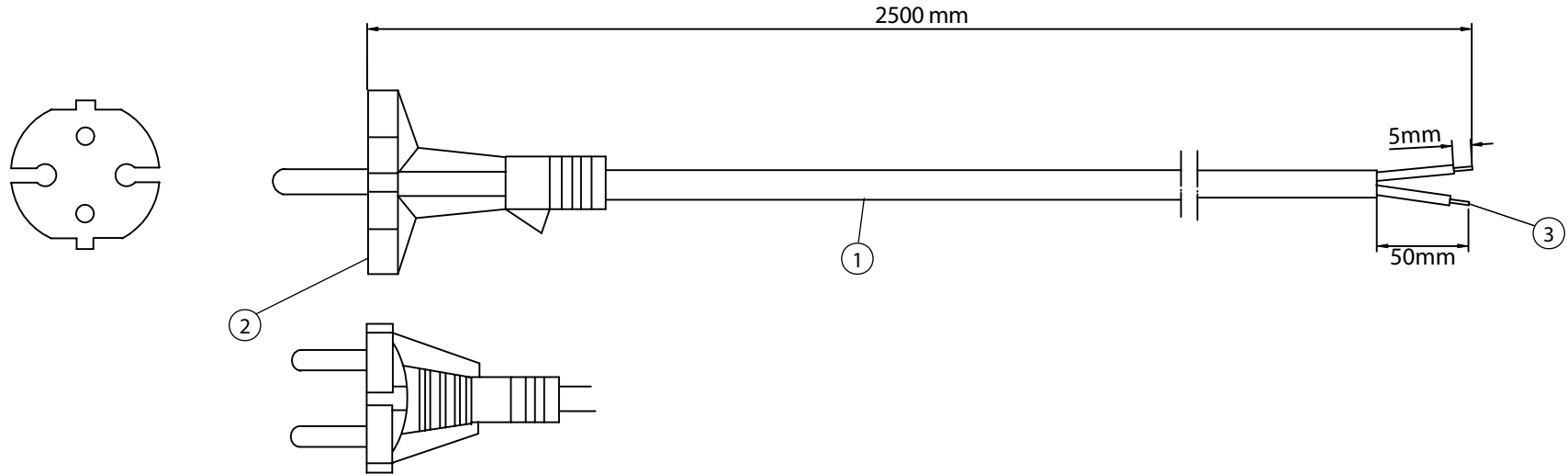

CONTROLLED

NOTES:

1. CORDAGE: H05VV-F, 2x1.00mm, UNSHIELDED, CEE COLOR CODE, TEMP. RATING 70°C, RATING: 250V 10A, JACKET COLOR: BLACK
2. PLUG: CONTINENTAL EUROPE
3. OTHER END: ROJ 50mm STRIP 5mm
4. APPROVALS: GERMANY, SWITZERLAND, DENMARK, NORWAY, FINLAND, FRANCE, BELGIUM, ITALY, NETHERLANDS, SWEDEN, AUSTRIA
5. ROHS COMPLIANT

Dim range (mm)	Tolerance +/- (mm)	Qualtek Electronics Corp. PPC DIVISION		
0-1	0.15	Part Number: 362005-E01		RoHS Compliant
1-6	0.20	Description: POWER CORD		
6-18	0.30		UNIT: mm	REV. B
18-50	0.50	Drawn / Date	Checked / Date	Approved / Date
50-120	0.70	R.Nuti 08-22-07	08-22-07	JJH / 08-22-07
120-250	0.90			
250-500	1.20			