



Chipsmall Limited consists of a professional team with an average of over 10 year of expertise in the distribution of electronic components. Based in Hongkong, we have already established firm and mutual-benefit business relationships with customers from,Europe,America and south Asia,supplying obsolete and hard-to-find components to meet their specific needs.

With the principle of "Quality Parts,Customers Priority,Honest Operation,and Considerate Service",our business mainly focus on the distribution of electronic components. Line cards we deal with include Microchip,ALPS,ROHM,Xilinx,Pulse,ON,Everlight and Freescale. Main products comprise IC,Modules,Potentiometer,IC Socket,Relay,Connector.Our parts cover such applications as commercial,industrial, and automotives areas.

We are looking forward to setting up business relationship with you and hope to provide you with the best service and solution. Let us make a better world for our industry!



Contact us

Tel: +86-755-8981 8866 Fax: +86-755-8427 6832

Email & Skype: info@chipsmall.com Web: www.chipsmall.com

Address: A1208, Overseas Decoration Building, #122 Zhenhua RD., Futian, Shenzhen, China



3M™ Mini-Clamp Plug

Designed for Wiring Supplied from Japan and Asia, 2 mm, IDC, Wiremount

371 Series



- Designed to accommodate typical wiring specifications per Japanese and Asian suppliers
- No special wire preparation
- Integrated cable retention
- Design accepts multiple wire size diameters
- Easy, quick, and reliable IDC termination using a standard pliers
- Debris free wire termination
- Mating latches provide a reliable interconnection in demanding applications
- High number of mating cycles
- Compact design saves board space
- Reduces maintenance work by providing higher connection reliability
- See Regulatory Information Appendix (RIA) for chemical compliance information

Date Modified: March 31, 2008

TS-2092-C
Sheet 1 of 3

Physical

Insulation:

Material: Glass reinforced thermoplastic body & lower cover, transparent thermoplastic cover
Flammability: UL 94V-0
Color: Black body, cover-white & color (see Table 1)

Contact:

Material: Copper Alloy

Plating:

Underplating: 2.54 μm [100 $\mu\text{''}$] minimum Nickel
Wiping Area:: 0.2 μm [8 $\mu\text{''}$] minimum Gold with Lubricant
IDC: Nickel

Accommodation: Annealed Copper, high-strength Copper, or Copper Alloy. Bare, tinned, or tin overcoated, 20~26 AWG [0.14~0.5] stranded

Wire Insulation: Flexible vinyl, semi-rigid vinyl, x-linked polyethylene, or ETFE (see Table 1)

Marking: 3M Logo, Position Indicator, Wire Gauge, Insulator Material

Electrical

Current Rating: 3.0 Amps

Voltage Rating: 32 Volts

Insulation Resistance: $>1 \times 10^6 \Omega$ at 600 V_{DC}

Withstanding Voltage: 1,000 V_{RMS} at sea level

Environmental

Temperature Rating: -20°C to +85°C ambient (1.0 A max.)
-20°C to +75°C ambient (2.0 A max.)
-20 C to +60°C ambient (3.0 A max.)
(Note: UL rating is 65°C at 3.0A, 32V)

UL File No.: E68080

3M

Electronic Solutions Division
Interconnect Solutions
<http://www.3M.com/interconnects/>

3M is a trademark of 3M Company.
For technical, sales or ordering information call
800-225-5373

3M™ Mini-Clamp Plug

Designed for Wiring Supplied from Japan and Asia, 2 mm, IDC, Wiremount

371 Series

3 and 4 Position

| # Positions | Dim A |
|-------------|------------|
| 3 | 12.9 [.51] |
| 4 | 14.9 [.59] |

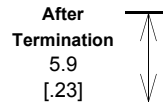
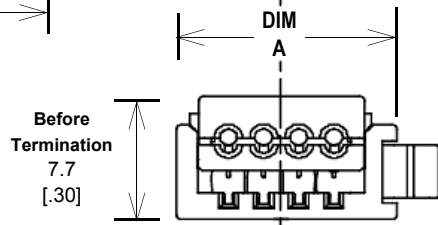
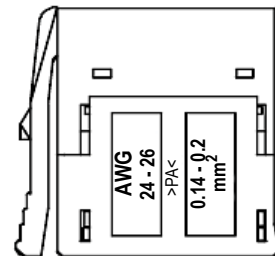
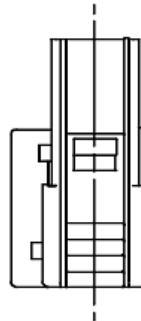
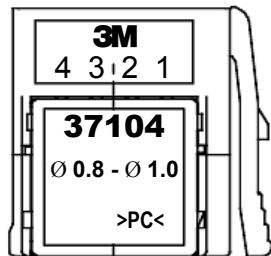
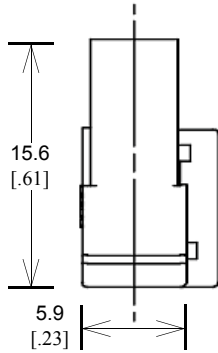
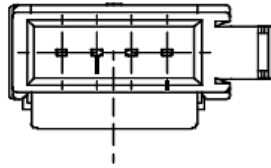

| Wire OD | 1.6 ~ 2.0 [.063 ~ .079] | 1.2 ~ 1.6 [.047 ~ .063] | 1.0 ~ 1.2 [.039 ~ .047] | 0.8 ~ 1.0 [.031 ~ .039] |
|---------------------|----------------------------|----------------------------|----------------------------|----------------------------|
| Part # 20-22 AWG | 2206 | 2165 | 2124 | |
| Cover Color | Gray | Blue | Green | |
| Part # 24-26 AWG | | 3163 | 3122 | 3101 |
| Color | | Orange | Yellow | Red |



| | mm [Inch] | |
|------------------------|--------------|------|
| Tolerance Unless Noted | | |
| | 0.0 | 0.00 |
| mm | ±.1 | ±.01 |

[] Dimensions for Reference only

Ordering Information

371XX - XXXX - 000 FL (RIA E1 & C1 apply)

Positions
03 or 04

Wire AWG & OD:
2XXX = 20-22 AWG
3XXX = 24-26 AWG
Wire OD - see Table 1

Note: Terminate using common pliers or 3M™ Scotchlok™ Crimping Tools E-9BM or E-9E

TS-2092-C
Sheet 2 of 3

3M™ Mini-Clamp Plug

Designed for Wiring Supplied from Japan and Asia, 2 mm, IDC, Wiremount

371 Series

6 and 8 Position

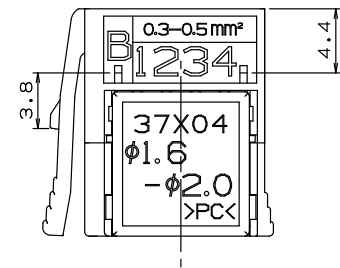
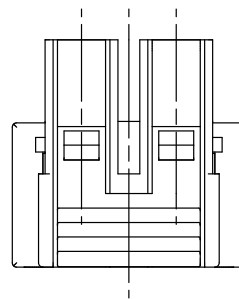
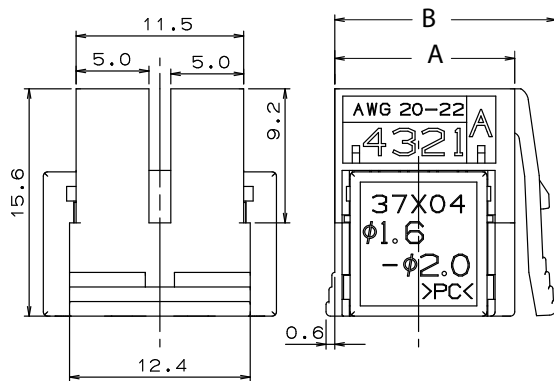
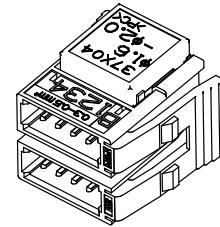
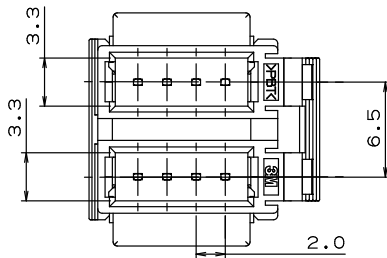

Before IDC

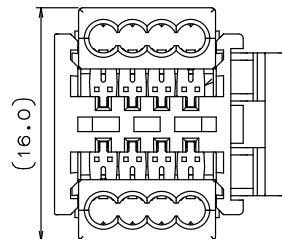

After IDC

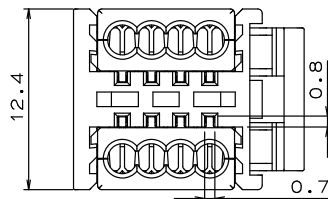

mm
[Inch]

| Tolerance Unless Noted | | |
|------------------------|-----|------|
| | .0 | .00 |
| mm | ±.1 | ±.10 |

[] Dimensions for Reference only

| # Positions | A | B (Ref.) |
|-------------|-------------|-------------|
| 6 (3x2) | 10.4 [0.41] | 13.2 [0.52] |
| 8 (4x2) | 12.4 [0.49] | 15.2 [0.60] |

Ordering Information

371XX - XXXX - 0W0 FL

Positions
06 or 08

Wire AWG & OD:
2XXX = 20-22 AWG
3XXX = 24-26 AWG
Wire OD – see Table

Note: Terminate using common pliers or 3M™ Scotchlok™ Crimping Tools E-9BM or E-9E

TS-2092-C
Sheet 3 of 3

Regulatory Information Appendix

3M Electronic Solutions Division/Interconnect

EUROPE

Appendix E1: European Union RoHS

Directive 2002/95/EC, Restriction of the Use of Certain Hazardous Substances in Electrical & Electronic Equipment, as amended by EU Commission Decision 2005/618/EC.

This product is RoHS Compliant 2005/95/EC.

“RoHS Compliant 2005/95/EC” means that the product or part (“Product”) does not contain any of the substances in excess of the maximum concentration values in EU Directive 2002/95/EC, as amended by Commission Decision 2005/618/EC, unless the substance is in an application that is exempt under EU RoHS. Unless otherwise stated by 3M in writing, this information represents 3M’s best knowledge and belief based upon information provided by third party suppliers to 3M.

In the event any product is proven not to conform with 3M’s Regulatory Information Appendix, then 3M’s entire liability and Buyer’s exclusive remedy will be in accordance with the Warranty stated below.

Appendix E2: European Union RoHS

Directive 2002/95/EC, Restriction of the Use of Certain Hazardous Substances in Electrical & Electronic Equipment, as amended by EU Commission Decision 2005/618/EC.

This product contains lead in the compliant pin area in excess of the maximum concentration value allowed but is compliant by exemption under EU Commission Decision 2005/747/EC.

“RoHS Compliant 2005/95/EC” means that the product or part (“Product”) does not contain any of the substances in excess of the maximum concentration values in EU Directive 2002/95/EC, as amended by Commission Decision 2005/618/EC, unless the substance is in an application that is exempt under EU RoHS. Unless otherwise stated by 3M in writing, this information represents 3M’s best knowledge and belief based upon information provided by third party suppliers to 3M.

In the event any product is proven not to conform with 3M’s Regulatory Information Appendix, then 3M’s entire liability and Buyer’s exclusive remedy will be in accordance with the Warranty stated below.

Appendix E3: European Union RoHS

Directive 2002/95/EC, Restriction of the Use of Certain Hazardous Substances in Electrical & Electronic Equipment as amended by Commission Decision 2005/618/EC.

This product contains lead in the solder tail area in excess of the maximum concentration value allowed.

Unless otherwise stated by 3M in writing, this information represents 3M’s best knowledge and belief based upon information provided by third party suppliers to 3M.

In the event any product is proven not to conform with 3M’s Regulatory Information Appendix, then 3M’s entire liability and Buyer’s exclusive remedy will be in accordance with the Warranty stated below.

Appendix E4: European Union RoHS

Directive 2002/95/EC, Restriction of the Use of Certain Hazardous Substances in Electrical & Electronic Equipment, as amended by EU Commission Decision 2005/618/EC.

This product contains decaBDE in the insulating material in excess of the maximum concentration value allowed but is compliant by exemption under EU Commission Decision 2005/717/EC.

“RoHS Compliant 2005/95/EC” means that the product or part (“Product”) does not contain any of the substances in excess of the maximum concentration values in EU Directive 2002/95/EC, as amended by Commission Decision 2005/618/EC, unless the substance is in an application that is exempt under EU RoHS. Unless otherwise stated by 3M in writing, this information represents 3M’s best knowledge and belief based upon information provided by third party suppliers to 3M.

In the event any product is proven not to conform with 3M’s Regulatory Information Appendix, then 3M’s entire liability and Buyer’s exclusive remedy will be in accordance with the Warranty stated below.

Appendix E5: European Union RoHS

Directive 2002/95/EC, Restriction of the Use of Certain Hazardous Substances in Electrical and Electronic Equipment, as amended by EU Commission Decision 2005/618/EC.

This product contains lead in excess of the maximum concentration value allowed but is compliant by exemption under Item 6 of the Annex to the Directive.

“RoHS Compliant 2005/95/EC” means that the product or part (“Product”) does not contain any of the substances in excess of the maximum concentration values in EU Directive 2002/95/EC, as amended by Commission Decision 2005/618/EC, unless the substance is in an application that is exempt under EU RoHS. Unless otherwise stated by 3M in writing, this information represents 3M’s best knowledge and belief based upon information provided by third party suppliers to 3M.

In the event any product is proven not to conform with 3M’s Regulatory Information Appendix, then 3M’s entire liability and Buyer’s exclusive remedy will be in accordance with the Warranty stated below.

CHINA

Appendix C1: China RoHS



Electronic Industry Standard of the People’s Republic of China, SJ/T11363-2006, Requirements for Concentration Limits for Certain Hazardous Substances in Electronic Information Products.

This symbol, per Marking for the Control of Pollution Caused by Electronic Information Products, SJ/T11364-2006, means that the product or part **does not** contain any of the following substances in excess of the following maximum concentration values in any homogeneous material: (a) 0.1% (by weight) for lead, mercury, hexavalent chromium, polybrominated biphenyls or polybrominated diphenyl ethers; or (b) 0.01% (by weight) for cadmium. Unless otherwise stated by 3M in writing, this information represents 3M’s best knowledge and belief based upon information provided by third party suppliers to 3M.

In the event any product is proven not to conform with 3M’s Regulatory Information Appendix, then 3M’s entire liability and Buyer’s exclusive remedy will be in accordance with the Warranty stated below.

Appendix C2: China RoHS



Electronic Industry Standard of the People’s Republic of China, SJ/T11363-2006, Requirements for Concentration Limits for Certain Hazardous Substances in Electronic Information Products.

This symbol, per Marking for the Control of Pollution Caused by Electronic Information Products, SJ/T11364-2006, means that the product or part **does** contain a substance, as detailed in the chart below, in excess of the following maximum concentration values in any homogeneous material: (a) 0.1% (by weight) for lead, mercury, hexavalent chromium, polybrominated biphenyls or polybrominated diphenyl ethers; or (b) 0.01% (by weight) for cadmium. Unless otherwise stated by 3M in writing, this information represents 3M’s best knowledge and belief based upon information provided by third party suppliers to 3M.

The numerical reference in the symbol above should not be construed as a representation regarding the product’s life or an extension of a product warranty. The product warranty is stated below. In the event any product is proven not to conform with 3M’s Regulatory Information Appendix, then 3M’s entire liability and Buyer’s exclusive remedy will be in accordance with the product Warranty stated below.

产品中有毒有害物质或元素的名称及含量 Name and Content of Hazardous Substances or Elements

| 部件名称 (Part or Component Name) | 有毒有害物质或元素 (Hazardous Substances or Elements) | | | | | |
|---|--|-------|-------|-------------|-----------|-------------|
| | 铅(Pb) | 汞(Hg) | 镉(Cd) | 六价铬(Cr(VI)) | 多溴联苯(PBB) | 多溴二苯醚(PBDE) |
| 端子镀层(contact plating) | × | ○ | ○ | ○ | ○ | ○ |
| ○: 表示该有毒有害物质在该部件所有均质材料中的含量均在SJ/T11363-2006 标准规定的限量要求以下。(Indicates that this hazardous substance contained in all of the homogeneous materials for this part is below the limit requirement in SJ/T11363-2006.) ×: 表示该有毒有害物质至少在该部件的某一均质材料中的含量超出SJ/T11363-2006 标准规定的限量要求。(Indicates that this hazardous substance contained in at least one of the homogeneous materials used for this part is above the limit requirement in SJ/T11363-2006.) | | | | | | |

Appendix C3: China RoHS

Electronic Industry Standard of the People's Republic of China, SJ/T11363-2006, Requirements for Concentration Limits for Certain Hazardous Substances in Electronic Information Products.

This symbol, per Marking for the Control of Pollution Caused by Electronic Information Products, SJ/T11364-2006, means that the product or part **does** contain a substance, as detailed in the chart below, in excess of the following maximum concentration values in any homogeneous material: (a) 0.1% (by weight) for lead, mercury, hexavalent chromium, polybrominated biphenyls or polybrominated diphenyl ethers; or (b) 0.01% (by weight) for cadmium. Unless otherwise stated by 3M in writing, this information represents 3M's best knowledge and belief based upon information provided by third party suppliers to 3M.

The numerical reference in the symbol above should not be construed as a representation regarding the product's life or an extension of a product warranty. The product warranty is stated below. In the event any product is proven not to conform with 3M's Regulatory Information Appendix, then 3M's entire liability and Buyer's exclusive remedy will be in accordance with the product Warranty stated below.

产品中有毒有害物质或元素的名称及含量 Name and Content of Hazardous Substances or Elements

| 部件名称 (Part or Component Name) | 有毒有害物质或元素 (Hazardous Substances or Elements) | | | | | |
|--|--|-------|-------|-------------|-----------|-------------|
| | 铅(Pb) | 汞(Hg) | 镉(Cd) | 六价铬(Cr(VI)) | 多溴联苯(PBB) | 多溴二苯醚(PBDE) |
| 合金(Metal alloy) | × | ○ | ○ | ○ | ○ | ○ |
| <p>○: 表示该有毒有害物质在该部件所有均质材料中的含量均在SJ/T11363-2006 标准规定的限量要求以下。(Indicates that this hazardous substance contained in all of the homogeneous materials for this part is below the limit requirement in SJ/T11363-2006.)</p> <p>×: 表示该有毒有害物质至少在该部件的某一均质材料中的含量超出SJ/T11363-2006 标准规定的限量要求。(Indicates that this hazardous substance contained in at least one of the homogeneous materials used for this part is above the limit requirement in SJ/T11363-2006.)</p> | | | | | | |

Important Notice

All statements, technical information, and recommendations related to 3M's products are based on information believed to be reliable, but the accuracy or completeness is not guaranteed. Before using this product, you must evaluate it and determine if it is suitable for your intended application. You assume all risks and liability associated with such use. Any statements related to the product which are not contained in 3M's current publications, or any contrary statements contained on your purchase order shall have no force or effect unless expressly agreed upon, in writing, by an authorized officer of 3M.

Warranty; Limited Remedy; Limited Liability.

This product will be free from defects in material and manufacture for a period of one (1) year from the time of purchase. **3M MAKES NO OTHER WARRANTIES INCLUDING, BUT NOT LIMITED TO, ANY IMPLIED WARRANTY OF MERCHANTABILITY OR FITNESS FOR A PARTICULAR PURPOSE.** If this product is defective within the warranty period stated above, your exclusive remedy shall be, at 3M's option, to replace or repair the 3M product or refund the purchase price of the 3M product. **Except where prohibited by law, 3M will not be liable for any indirect, special, incidental or consequential loss or damage arising from this 3M product, regardless of the legal theory asserted.**



3M Electronic Solutions Division

6801 River Place Blvd.
Austin, TX 78726-9000
U.S.A.
1-800-225-5373
www.3m.com/interconnects

Please recycle. Printed in USA.
© 3M 2008. All rights reserved.
RIA-2217B-D

3M is a trademark of 3M Company.