



Chipsmall Limited consists of a professional team with an average of over 10 year of expertise in the distribution of electronic components. Based in Hongkong, we have already established firm and mutual-benefit business relationships with customers from,Europe,America and south Asia,supplying obsolete and hard-to-find components to meet their specific needs.

With the principle of “Quality Parts,Customers Priority,Honest Operation,and Considerate Service”,our business mainly focus on the distribution of electronic components. Line cards we deal with include Microchip,ALPS,ROHM,Xilinx,Pulse,ON,Everlight and Freescale. Main products comprise IC,Modules,Potentiometer,IC Socket,Relay,Connector.Our parts cover such applications as commercial,industrial, and automotives areas.

We are looking forward to setting up business relationship with you and hope to provide you with the best service and solution. Let us make a better world for our industry!



Contact us

Tel: +86-755-8981 8866 Fax: +86-755-8427 6832

Email & Skype: info@chipsmall.com Web: www.chipsmall.com

Address: A1208, Overseas Decoration Building, #122 Zhenhua RD., Futian, Shenzhen, China



3M™ Mini-Clamp Socket

2 mm, Surfacemount, Right Angle

372 Series

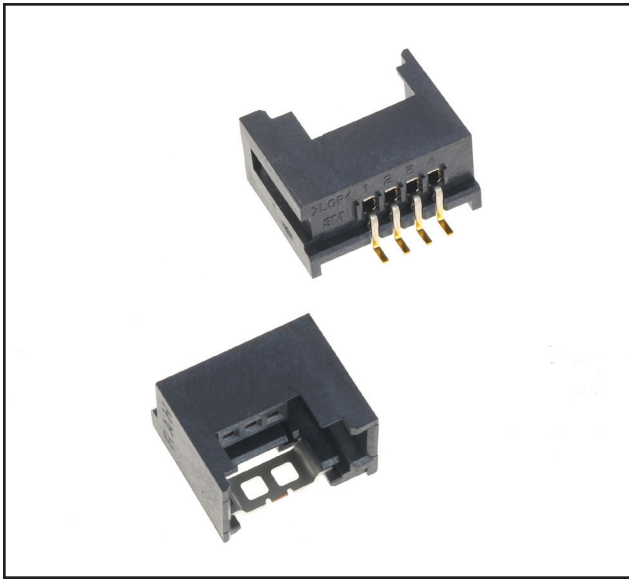

- Low profile design minimizes overall thickness
- Compact design saves board space
- Multiple PCB locating post layouts to ensure competitive compatibility
- Solder tab design helps ensure a reliable solder joint
- Mating Latch feature provides a reliable interconnection in demanding applications
- High number of mating cycles (300)
- Maximum current rating of 3 Amps
- Dust cover accessory available for use in harsh environment
- Available in Tape and Reel
- RoHS Compliant. See the Regulatory Information Appendix (RIA) in the “RoHS compliance” section of www.3Mconnector.com for compliance information (RIA E1 & C1 apply)

Date Modified: July 14, 2011

TS-2271-C
Sheet 1 of 4

Physical

Insulation:

Material: LCP
Flammability: UL 94V-0
Color: Black

Contact:

Material: Copper Alloy

Plating:

Underplating: 100 μ" [2.54 μm] Ni
Wiping Area: 0.2 μm [8 μ"] min Gold with Lubricant
Solder Tails: Gold Flash
Solder Tabs: 120 μ" min [3 μm min] Matte Sn over 40 μ"-120 μ" [1-3 μm] Ni

Marking: 3M Logo, Position Indicator, Insulator Material

Mating Compatibility: 371 Series

Electrical

Current Rating: 3.0 A

Voltage Rating: 32 V

Insulation Resistance: 1,000 MΩ minimum at 500 V_{DC}

Withstanding Voltage: 1,000 V_{RMS} for 1 minute

Environmental

Temperature Rating: -20°C to +85°C ambient (1.0 A max.)
-20°C to +75°C ambient (2.0 A max.)
-20°C to +60°C ambient (3.0 A max.)
(Note: UL rating is 65 C at 3.0 A, 32 V)

Process Rating: 260°C max. SMT reflow (J-STD-020 MSL1)
390°C max. for soldering iron

UL File No.: E68080

3M

Electronic Solutions Division
Interconnect Solutions
<http://www.3Mconnector.com>

3M is a trademark of 3M Company.
For technical, sales or ordering information call
800-225-5373

3M™ Mini-Clamp Socket

2 mm, Surfacement, Right Angle

372 Series

3 and 4 Position Socket

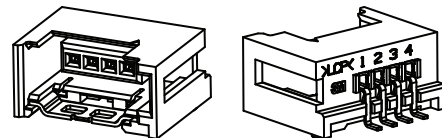
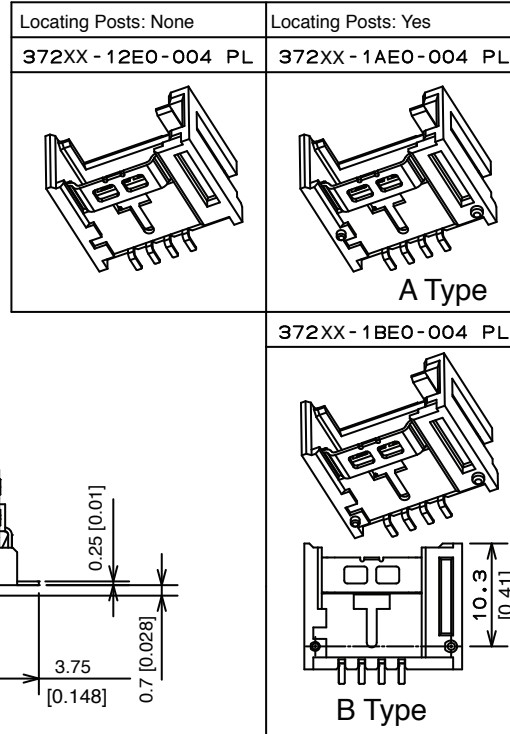
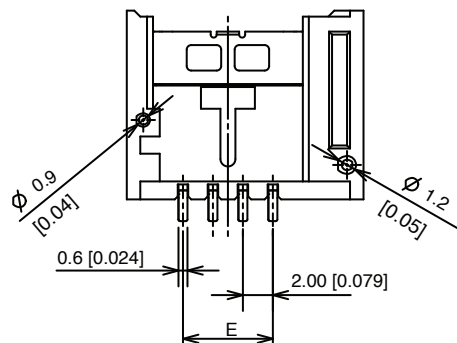
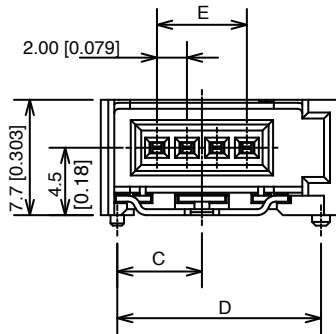
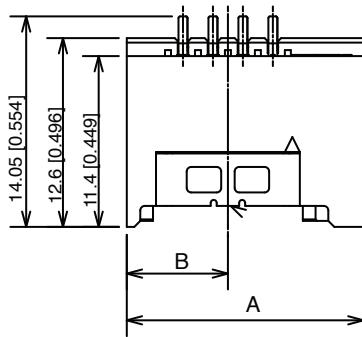

Pins	A	B	C	D	E
3	13.8 [0.54]	5.75 [.23]	4.65 [0.18]	11.6 [0.46]	4.00 [0.157]
4	15.8 [0.62]	6.75 [0.27]	5.65 [0.22]	13.6 [0.54]	6.00 [0.236]

mm [inch]			
Tolerance Unless Noted			
	.0	.00	.000
mm	±.3	±.13	

[], () Dimensions for Reference Only

Ordering Information

Available Combinations

- 37203-1AE0-003 PL
- 37203-1BE0-003 PL
- 37203-12E0-003 PL
- 37204-1AE0-004 PL
- 37204-1BE0-004 PL
- 37204-12E0-004 PL

372XX-1XE0-00X PL (RIA E1 and C1 Apply)

- Positions
03 or 04
- Locating Posts
A = Asymmetric
B = Symmetric
2 = None
- Mating Plug Size
3 or 4

TS-2271-C
Sheet 2 of 4



Electronic Solutions Division
Interconnect Solutions
<http://www.3Mconnector.com>

3M is a trademark of 3M Company.
For technical, sales or ordering information call
800-225-5373

3M™ Mini-Clamp Socket

2 mm, Surfacement, Right Angle

372 Series

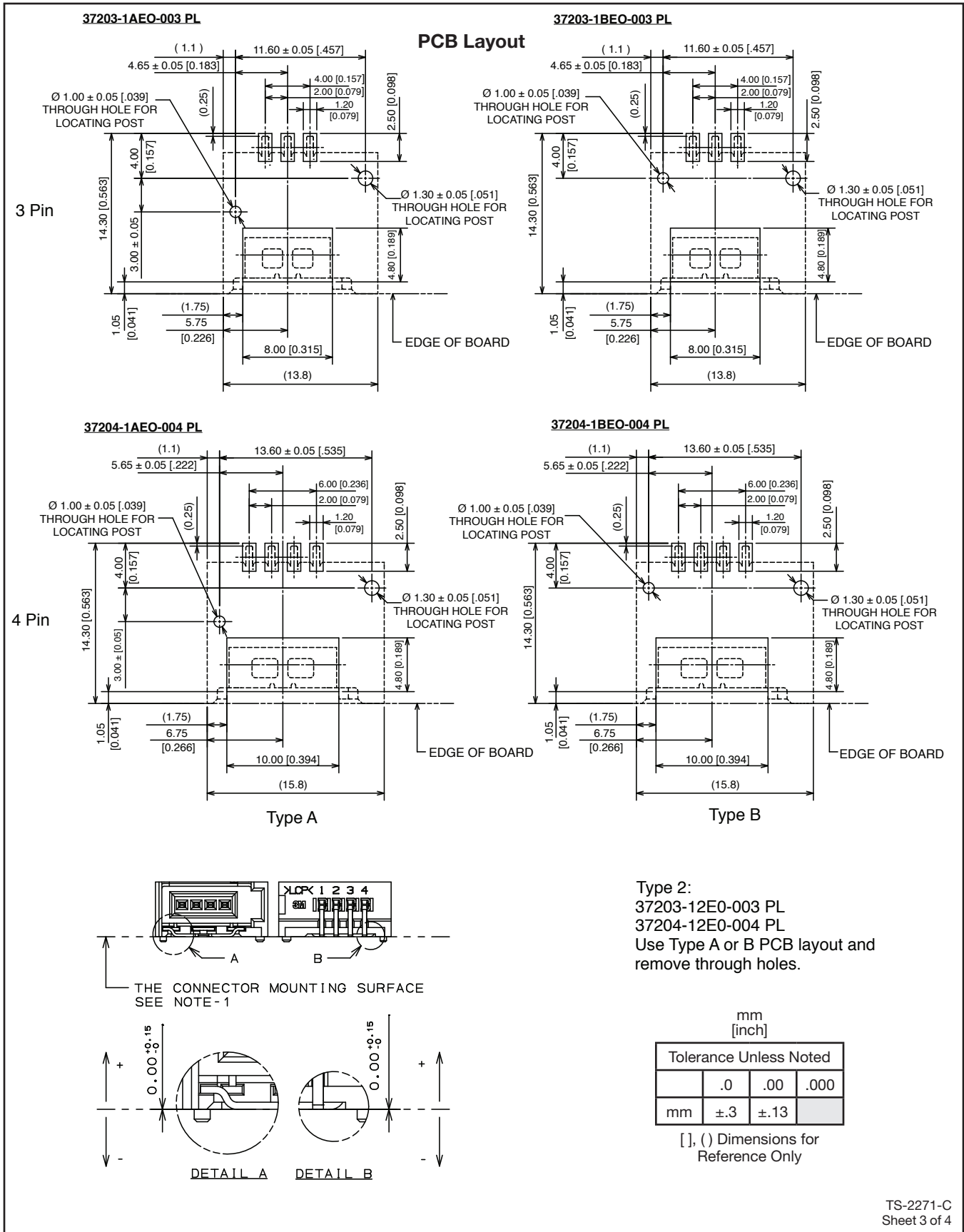

TS-2271-C
 Sheet 3 of 4

3M™ Mini-Clamp Socket

2 mm, Surfacemount, Right Angle

372 Series

Tape and Reel Packaging

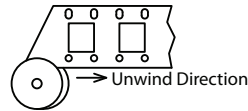
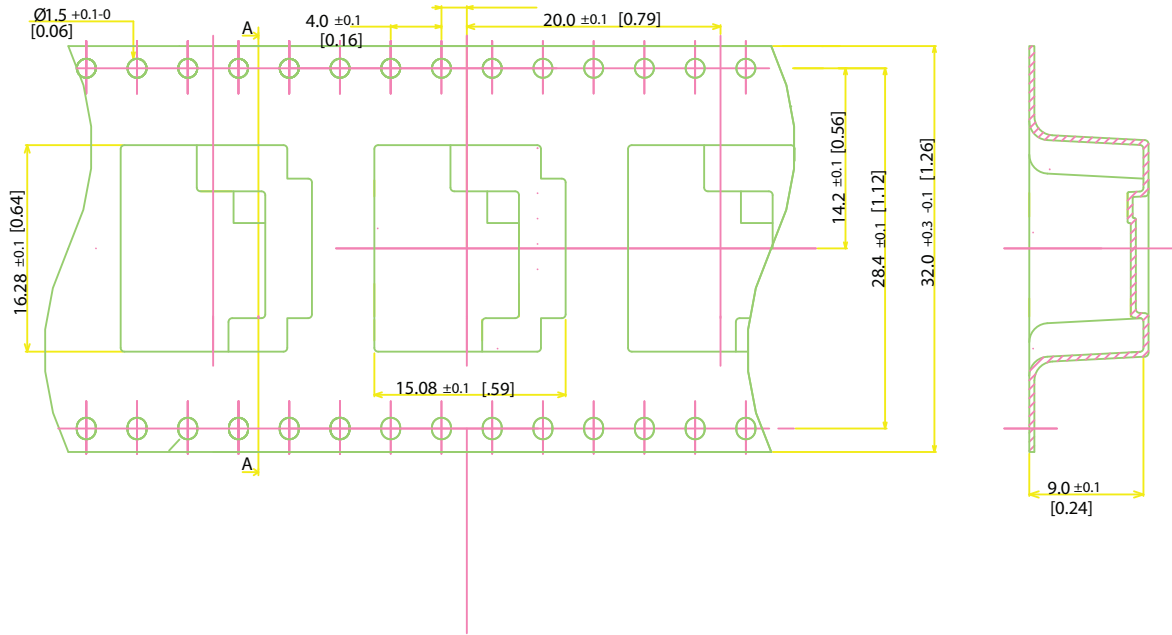

Accessories

Dust Cover Accessory



Ordering Information:

3 pos - 37803-1000-00

4 pos - 37804-1000-00

TS-2271-C
Sheet 4 of 4