



Chipsmall Limited consists of a professional team with an average of over 10 year of expertise in the distribution of electronic components. Based in Hongkong, we have already established firm and mutual-benefit business relationships with customers from,Europe,America and south Asia,supplying obsolete and hard-to-find components to meet their specific needs.

With the principle of “Quality Parts,Customers Priority,Honest Operation,and Considerate Service”,our business mainly focus on the distribution of electronic components. Line cards we deal with include Microchip,ALPS,ROHM,Xilinx,Pulse,ON,Everlight and Freescale. Main products comprise IC,Modules,Potentiometer,IC Socket,Relay,Connector.Our parts cover such applications as commercial,industrial, and automotives areas.

We are looking forward to setting up business relationship with you and hope to provide you with the best service and solution. Let us make a better world for our industry!



Contact us

Tel: +86-755-8981 8866 Fax: +86-755-8427 6832

Email & Skype: info@chipsmall.com Web: www.chipsmall.com

Address: A1208, Overseas Decoration Building, #122 Zhenhua RD., Futian, Shenzhen, China



PROTEKTIVE PAK

BURIED SHIELDING LAYER

Your Complete ESD Packaging Solution



Made in the United States
of America



Table of Contents

Impregnated vs. Coated	4
Protektive Pak® Impregnated Corrugated Product	
In-Plant Handlers.....	5-8
In-Plant Handler Accessories	9
Adjustable In-Plant Handlers	10
Storage Containers	11
Small Component Shippers.....	12
Circuit Board Shippers	12
Board Handler Trays	13
Tek Trays™	13
Super Tek Trays.....	13
Mini Tek Trays™	14
Tek Tray Partition Set	14
Tek Tray Drop-In Lid	14
Tek Mate™ Board Handlers.....	15
Pro Mat™	15
Open Bin Boxes	16
Closed Bin Boxes	16
Reel Dip Tube Bin Boxes	17
Reel Storage Containers	17
Universal Organizers.....	18
Tool Carrier and Lid	18
ESD Turntable.....	19
Trash Receptacle and Liners	19
Plastek™ Product	
In-Plant Handlers.....	20-22
Storage Containers	23
Tek Trays	23
Open Bin Boxes	24
Plastek Sheets	24
Plastek Turntable	25
Vertical Reel Holders.....	25
Miscellaneous Product	
Conductive Hinged Boxes with Foam	26
Conductive Kitting Trays	26
Velostat Drum Liners.....	27
Velostat Hinged Containers.....	27
Velostat Round Containers	27
Black Foam	28
Pink Foam and Custom Foam	29
Wescorp Antistatic Tape	30
Lead-Free Zone Aisle Marking Tape.....	31
Lead-Free Marking Tape.....	31
Carton Tape	31
ESD Susceptibility Labels	32
Lead-Free Zone Attention Sign.....	32
Lead-Free Label, RoHS Compliant.....	32
Static Dissipative Document Holders	33
Lead-Free Shop Travelers	33
Desiccant Packs & Humidity Cards.....	33
Metal-In Shielding Bags	34
Metal-Out Shielding Bags.....	34
Moisture Barrier Bags.....	35
Pink Poly Bags	35

IMPREGNATED CORRUGATED



PLASTEK™



MISCELLANEOUS





Yes! We do Customs.

We can create the exact container that you need to store or transport your components, assemblies, or products.

Get a no-charge custom packaging quotation. Just send us:

- A drawing or sample box
- The quantity you'd like us to quote
- Specify either Protektive Pak corrugated or Plastek™ material

Phone: (909) 627-2578

E-mail: Service@ProtektivePak.com

Visit our web site for featured custom: ProtektivePak.com



Limited Warranty

WE GUARANTEE YOU WILL BE SATISFIED WITH OUR PRODUCTS.

We make every effort to see to it that our products are of the highest quality and meet all appropriate recognized industry standards. All statements, technical data, and recommendations contained herein are based upon tests we believe to be reliable. However, the accuracy or completeness thereof is not guaranteed. The proper and correct application of products and data is the responsibility of the user. The following is made in lieu of all warranties, expressed or implied:

Protektive Pak's only obligation shall be to replace such quantity of the product proved to be defective. Protektive Pak shall not be liable for any injury, loss, or damage, direct or consequential, arising out of the use of or the inability to use the product. Before using, users shall determine the suitability of the product for their intended use, and users assume all risk and liability whatsoever in connection therewith.

No statement or recommendation not contained herein shall have any force or effect unless embodied in a written agreement signed by authorized officers of Desco Industries, Inc.

LIMITED WARRANTY: Protektive Pak expressly warrants that for a period of one (1) year from the date of purchase, products will be free of defects in materials (parts) and workmanship (labor). For complete warranty information, go to: ProtektivePak.com





Independent ESD Tests Prove Protektive Pak Impregnated Corrugated Material is Superior. Proven...

- Protektive Pak impregnated corrugated material has a buried shielding layer
- Protektive Pak impregnated corrugated material equals or exceeds the discharge shielding capabilities of a coated box
- Protektive Pak impregnated corrugated material has discharge shielding capabilities equal to a metal-out shielding bag
- Protektive Pak Dissipative Corrugated Material meets the ANSI/ESD S541 recommendation, avoiding rapid discharge when contacting ESD sensitive items - **conductive boxes DO NOT!**

See Test Report on our homepage at ProtektivePak.com

Superiority of Protektive Pak Impregnated Corrugated* vs. Coated Material

*Meets ANSI/ESD S20.20 and Packaging standard ANSI/ESD S541

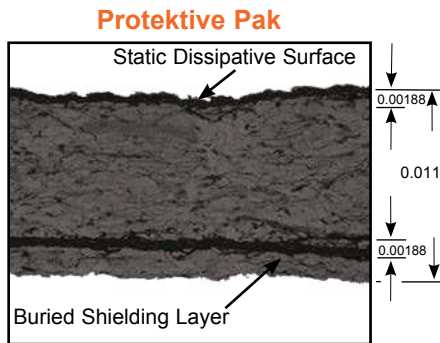

Microscopic cross section of Protektive Pak's impregnated corrugated

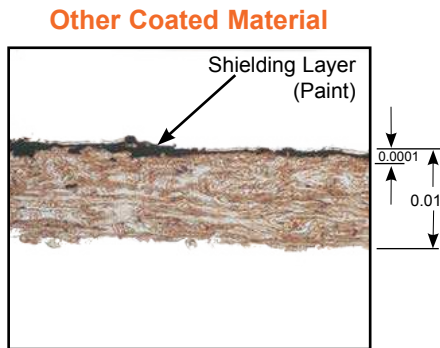

Microscopic cross section of carbon coated linerboard

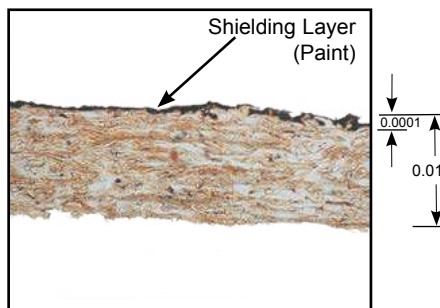

Microscopic cross section of graphite printed linerboard

All microscopic photos are approximately the same scale.

	Impregnated	vs.	Coated Material
1	CONSISTENT QUALITY Manufactured by one paper mill with computerized control, resulting in consistent high quality.		Manufactured without computer controls and applied at various geographical locations, resulting in quality variations.
2	STATE-OF-THE-ART TECHNOLOGY Carbon is added during the paper making process. The paper is a 6 layer process. The top surface layer is static dissipative, measuring 10E6 to 10E8 ohms. The conductive layer is in the 5th layer from the surface measuring <10E4 ohms.		Material is coated or printed with carbon loaded black ink which is then coated with a clear sealer to help coating stay on. Shielding layer is very close to surface and high carbon content can bleed through. Result is poor and inconsistent static dissipative effectiveness.
3	LOWER SULFUR CONTENT Manufactured from 100% recycled paper with consistently low sulfur content.		Manufactured from either recycled or virgin paper or a combination of both. Sulfur content may be low or high which can cause corrosion to leads and circuits.
4	GREATER DURABILITY 1,000 Times Thicker Abrasion tests have shown no loss in particles at 100 cycles, only 1% loss for 200 cycles and 60% loss for 500 cycles.		Tests have shown a 50% loss in particles in only 10 cycles and a 100% loss in 100 cycles.
5	SLOWS RAPID DISCHARGE Burying the conductive layer under a dissipative surface reduces the potential for a rapid discharge when contacted by a charged device.		A very conductive surface that may pose a charged device model (CDM) ESD danger to components stored in open bin boxes, in-plant handlers, shippers, totes, nesting trays, etc.
6	BETTER SHIELDING EFFECTIVENESS Shielding effectiveness is equal to or greater than coated conductive materials.		Some coated products shield poorly due to inconsistent application procedures by some manufacturers.
7	BETTER VALUE More durable structure, 1,000 times thicker, which consistently shields your product from ESD, is also safer and better for the environment.		Simple structure which can lack consistency of ESD shielding, durability, and safety.





In-Plant Handlers

Lid is included for all In-Plant Handlers



**Find the
optimal size
In-Plant
Handler that
you need.**

See the Tek-Search
on our web site:

ProtektivePak.com

Just enter the size of your circuit board
(length x width x thickness) and you
will be provided with a list of the most
efficient In-Plant Handlers.

IN-PLANT HANDLER FEATURES

- Meets ANSI/ESD S20.20 and Packaging Standard ANSI/ESD S541
- Provides ESD and physical protection for ESD sensitive circuit boards and components; with lid in place, shielding creates "Faraday Cage" restricting electrostatic charges to exterior
- To ship or store ESD sensitive items outside an ESD protected area (Ref: ANSI/ESD S20.20)
- Impregnated corrugated material; greater durability than coated or printed material
- Constructed with double sides, double (boxes under 6" deep) or triple (boxes over 6" deep) ends, and single (boxes under 6" deep) or double (boxes over 6" deep) thickness bottom for greater durability
- Easy assembly without the need for tape, glue, or staples
- Great container for Kanban
- Made in the United States of America

Download Drawing [37150](#)

NOTE: Shielding bag not required.

Per ESD Association "Dissipative Material for Intimate Contact, to avoid rapid discharge to sensitive items, dissipative materials should be used as the layer of packaging that contacts the item." "Static Shielding Property, Electrostatic shielding materials protect packaged sensitive electronic items from the effects of static electricity that are external to the package." (Packaging Standard ANSI/ESD S541)

Features of all Protektive Pak Impregnated Corrugated Material

- Static dissipative surface of 1×10^6 to $<1 \times 10^9$ ohms tested per ANSI/ESD STM11.11 - minimizing the potential of rapid discharge or sparking
- Buried shielding layer protects ESDS items, minimizing the potential of sloughing and rub-off contamination
- Made from 100% recycled material, and is 100% recyclable
- No tooling costs
- Reusable, ensuring best value





In-Plant Handlers

Lid is included for all In-Plant Handlers

Inside Box Dimensions: 17" x 9-7/8" x 2-1/2"					
37509 Series	Cell Size			# of Cells Per Box	Reference #
Part #	Length	Width	Thickness		
37233	2-1/2"	2-1/4"	3/4"	60	422-09V07-60
37229	2-1/2"	2-1/4"	1-3/4"	30	422-04V07-30A
37232	2-1/2"	4-3/4"	3/4"	30	422-09V04-30
37228	2-1/2"	4-3/4"	1-3/4"	15	422-04V04-15A
37231	2-1/2"	7-1/4"	3/4"	20	422-09V03-20
37227	2-1/2"	7-1/4"	1-3/4"	10	422-04V03-10A
37230	2-1/2"	14-3/4"	3/4"	10	422-09V02-10
37226	2-1/2"	14-3/4"	1-3/4"	5	422-04V02-5A

Available with 37451 bottom foam. Not available with ESD Handles or wire frames.

Inside Box Dimensions: 16-7/8" x 10" x 3-1/2"					
37508 Series	Cell Size			# of Cells Per Box	Reference #
Part #	Length	Width	Thickness		
37225	3-1/2"	2-1/4"	3/4"	60	411-09V07-60
37221	3-1/2"	2-1/4"	1-3/4"	30	411-04V07-30A
37224	3-1/2"	4-3/4"	3/4"	30	411-09V04-30
37220	3-1/2"	4-3/4"	1-3/4"	15	411-04V04-15A
37223	3-1/2"	7-1/4"	3/4"	20	411-09V03-20
37219	3-1/2"	7-1/4"	1-3/4"	10	411-04V03-10A
37222	3-1/2"	14-3/4"	3/4"	10	411-09V02-10
37218	3-1/2"	14-3/4"	1-3/4"	5	411-04V02-5A

Available with 37451 bottom foam. Not available with ESD Handles or wire frames.

Inside Box Dimensions: 16-7/8" x 10" x 5-3/8"					
37501 Series	Cell Size			# of Cells Per Box	Reference #
Part #	Length	Width	Thickness		
37165	5-3/8"	2-1/4"	3/4"	60	401-09V07-60
37161	5-3/8"	2-1/4"	1-3/4"	30	401-04V07-30A
37164	5-3/8"	4-3/4"	3/4"	30	401-09V04-30
37160	5-3/8"	4-3/4"	1-3/4"	15	401-04V04-15A
37163	5-3/8"	7-1/4"	3/4"	20	401-09V03-20
37159	5-3/8"	7-1/4"	1-3/4"	10	401-04V03-10A
37162	5-3/8"	14-3/4"	3/4"	10	401-09V02-10
37158	5-3/8"	14-3/4"	1-3/4"	5	401-04V02-5A

Available with 37451 bottom foam. Not available with ESD Handles or wire frames.

Inside Box Dimensions: 18-5/8" x 15" x 5-7/8"					
37506 Series	Cell Size			# of Cells Per Box	Reference #
Part #	Length	Width	Thickness		
37211	5-7/8"	4"	1-1/4"	40	406-09V05-40
37207	5-7/8"	4"	2-3/4"	20	406-04V05-20A
37210	5-7/8"	5-3/8"	1-1/4"	30	406-09V04-30
37206	5-7/8"	5-3/8"	2-3/4"	15	406-04V04-15A
37203*	5-7/8"	6-1/4"	1-1/4"	24	406-03H11-24
37202*	5-7/8"	6-1/4"	1-5/8"	20	406-03H09-20
37201*	5-7/8"	6-1/4"	2-7/8"	12	406-03H05-12A
37200*	5-7/8"	6-1/4"	3-5/8"	10	406-03H04-10A
37213	5-7/8"	8-1/8"	1"	24	406-11V03-24
37209	5-7/8"	8-1/8"	1-1/4"	20	406-09V03-20
37205	5-7/8"	8-1/8"	2-3/4"	10	406-04V03-10A
37199*	5-7/8"	12-3/4"	1-1/4"	12	406-02H11-12
37198*	5-7/8"	12-3/4"	1-5/8"	10	406-02H09-10
37197*	5-7/8"	12-3/4"	2-7/8"	6	406-02H05-6A
37196*	5-7/8"	12-3/4"	3-5/8"	5	406-02H04-5A
37212	5-7/8"	16-5/8"	1"	12	406-011V02-12
37208	5-7/8"	16-5/8"	1-1/4"	10	406-09V02-10
37204	5-7/8"	16-5/8"	2-3/4"	5	406-04V02-5A

Available with 37455 bottom foam, 37450 ESD Handles, and 37459 wire frame.

Inside Box Dimensions: 22-7/8" x 12-7/8" x 6"					
37516 Series	Cell Size			# of Cells Per Box	Reference #
Part #	Length	Width	Thickness		
37293	6"	4-3/4"	1"	40	446-09V05-40
37289	6"	4-3/4"	2-1/4"	20	446-04V05-20A
37285*	6"	5-3/16"	1-5/8"	24	446-03H11-24
37284*	6"	5-3/16"	3-5/8"	12	446-03H05-12A
37292	6"	6-1/2"	1"	30	446-09V04-30
37288	6"	6-1/2"	2-1/4"	15	446-04V04-15A
37291	6"	10"	1"	20	446-09V03-20
37287	6"	10"	2-1/4"	10	446-04V03-10A
37283*	6"	10-3/4"	1-5/8"	12	446-02H11-12
37282*	6"	10-3/4"	3-5/8"	6	446-02H05-6A
37290	6"	20-1/8"	1"	10	446-09V02-10
37286	6"	20-1/8"	2-1/4"	5	446-04V02-5A

Available with 37453 bottom foam, 37450 ESD Handles, and 37457 wire frame.

Inside Box Dimensions: 17" x 9-7/8" x 7-1/4"					
37500 Series	Cell Size			# of Cells Per Box	Reference #
Part #	Length	Width	Thickness		
37157	7-1/4"	2-1/4"	3/4"	60	400-09V07-60
37153	7-1/4"	2-1/4"	1-3/4"	30	400-04V07-30A
37156	7-1/4"	4-3/4"	3/4"	30	400-09V04-30
37152	7-1/4"	4-3/4"	1-3/4"	15	400-04V04-15A
37155	7-1/4"	7-1/4"	3/4"	20	400-09V03-20
37151	7-1/4"	7-1/4"	1-3/4"	10	400-04V03-10A
37154	7-1/4"	14-3/4"	3/4"	10	400-09V02-10
37150	7-1/4"	14-3/4"	1-3/4"	5	400-04V02-5A

Available with 37451 bottom foam and 37450 ESD Handles. Wire frames not available.

- * ESD handles included
- These items made to order

All Protektive Pak In-Plant Handlers include:

- Storage container
- Partition set
- Lid





In-Plant Handlers

Lid is included for all In-Plant Handlers

Inside Box Dimensions: 22-7/8" x 12-7/8" x 8"					
37517 Series	Cell Size			# of Cells Per Box	Reference #
Part #	Length	Width	Thickness		
37305	8"	4-3/4"	1"	40	448-09V05-40
37301	8"	4-3/4"	2-1/4"	20	448-04V05-20A
37297*	8"	5-3/16"	1-5/8"	24	448-03H11-24
37296*	8"	5-3/16"	3-5/8"	12	448-03H05-12A
37304	8"	6-1/2"	1"	30	448-09V04-30
37300	8"	6-1/2"	2-1/4"	15	448-04V04-15A
37303	8"	10"	1"	20	448-09V03-20
37299	8"	10"	2-1/4"	10	448-04V03-10A
37295*	8"	10-3/4"	1-5/8"	12	448-02H11-12
37294*	8"	10-3/4"	3-5/8"	6	448-02H05-6A
37302	8"	20-1/8"	1"	10	448-09V02-10
37298	8"	20-1/8"	2-1/4"	5	448-04V02-5A

Available with 37453 bottom foam, 37450 ESD Handles, and 37457 wire frame.

Inside Box Dimensions: 17" x 13" x 8-3/4"					
37512 Series	Cell Size			# of Cells Per Box	Reference #
Part #	Length	Width	Thickness		
37251	8-3/4"	4-5/8"	1"	30	438-09V04-30
37248	8-3/4"	4-5/8"	2-3/8"	15	438-04V04-15A
37250	8-3/4"	7-1/8"	1"	20	438-09V03-20
37247	8-3/4"	7-1/8"	2-3/8"	10	438-04V03-10A
37249	8-3/4"	14-5/8"	1"	10	438-09V02-10
37246	8-3/4"	14-5/8"	2-3/8"	5	438-04V02-5A

Available with 37452 bottom foam, 37450 ESD Handles, and 37456 wire frame.

Inside Box Dimensions: 18-5/8" x 15" x 8"					
37527 Series	Cell Size			# of Cells Per Box	Reference #
Part #	Length	Width	Thickness		
37398	8"	4"	1-1/4"	40	468-09V05-40
37394	8"	4"	2-3/4"	20	468-04V05-20A
37397	8"	5-3/8"	1-1/4"	30	468-09V04-30
37393	8"	5-3/8"	2-3/4"	15	468-04V04-15A
37390*	8"	6-1/4"	1-1/4"	24	468-03H11-24
37389*	8"	6-1/4"	1-5/8"	20	468-03H09-20
37388*	8"	6-1/4"	2-7/8"	12	468-03H05-12A
37387*	8"	6-1/4"	3-5/8"	10	468-03H04-10A
37400	8"	8-1/8"	1"	24	468-11V03-24
37396	8"	8-1/8"	1-1/4"	20	468-09V03-20
37392	8"	8-1/8"	2-3/4"	10	468-04V03-10A
37386*	8"	12-3/4"	1-1/4"	12	468-02H11-12
37385*	8"	12-3/4"	1-5/8"	10	468-02H09-10
37384*	8"	12-3/4"	2-7/8"	6	468-02H05-6A
37383*	8"	12-3/4"	3-5/8"	5	468-02H04-5A
37399	8"	16-5/8"	1"	12	468-11V02-12
37395	8"	16-5/8"	1-1/4"	10	468-09V02-10
37391	8"	16-5/8"	2-3/4"	5	468-04V02-5A

Available with 37455 bottom foam, 37450 ESD Handles, and 37459 wire frame.

Inside Box Dimensions: 18-5/8" x 15" x 10"					
37524 Series	Cell Size			# of Cells Per Box	Reference #
Part #	Length	Width	Thickness		
37344	10"	4"	1-1/4"	40	460-09V05-40
37340	10"	4"	2-3/4"	20	460-04V05-20A
37343	10"	5-3/8"	1-1/4"	30	460-09V04-30
37339	10"	5-3/8"	2-3/4"	15	460-04V04-15A
37336*	10"	6-1/4"	1-1/4"	24	460-03H11-24
37335*	10"	6-1/4"	1-5/8"	20	460-03H09-20
37334*	10"	6-1/4"	2-7/8"	12	460-03H05-12A
37333*	10"	6-1/4"	3-5/8"	10	460-03H04-10A
37346	10"	8-1/8"	1"	24	460-11V03-24
37342	10"	8-1/8"	1-1/4"	20	460-09V03-20
37338	10"	8-1/8"	2-3/4"	10	460-04V03-10A
37332*	10"	12-3/4"	1-1/4"	12	460-02H11-12
37331*	10"	12-3/4"	1-5/8"	10	460-02H09-10
37330*	10"	12-3/4"	2-7/8"	6	460-02H05-6A
37329*	10"	12-3/4"	3-5/8"	5	460-02H04-5A
37345	10"	16-5/8"	1"	12	460-11V02-12
37341	10"	16-5/8"	1-1/4"	10	460-09V02-10
37337	10"	16-5/8"	2-3/4"	5	460-04V02-5A

Available with 37455 bottom foam, 37450 ESD Handles, and 37459 wire frame.

Inside Box Dimensions: 22-7/8" x 12-7/8" x 10"					
37514 Series	Cell Size			# of Cells Per Box	Reference #
Part #	Length	Width	Thickness		
37269	10"	4-3/4"	1"	40	440-09V05-40
37265	10"	4-3/4"	2-1/4"	20	440-04V05-20A
37261*	10"	5-3/16"	1-5/8"	24	440-03H11-24
37260*	10"	5-3/16"	3-5/8"	12	440-03H05-12A
37268	10"	6-1/2"	1"	30	440-09V04-30
37264	10"	6-1/2"	2-1/4"	15	440-04V04-15A
37267	10"	10"	1"	20	440-09V03-20
37263	10"	10"	2-1/4"	10	440-04V03-10A
37259*	10"	10-3/4"	1-5/8"	12	440-02H11-12
37258*	10"	10-3/4"	3-5/8"	6	440-02H05-6A
37266	10"	20-1/8"	1"	10	440-09V02-10
37262	10"	20-1/8"	2-1/4"	5	440-04V02-5A

Available with 37453 bottom foam, 37450 ESD Handles, and 37457 wire frame.



- * ESD handles included
- These items made to order





In-Plant Handlers

Lid is included for all In-Plant Handlers

Inside Box Dimensions: 18-5/8" x 15" x 12"					
37525 Series	Cell Size			# of Cells Per Box	Reference #
Part #	Length	Width	Thickness		
37362	12"	4"	1-1/4"	40	462-09V05-40
37358	12"	4"	2-3/4"	20	462-04V05-20A
37361	12"	5-3/8"	1-1/4"	30	462-09V04-30
37357	12"	5-3/8"	2-3/4"	15	462-04V04-15A
37354*	12"	6-1/4"	1-1/4"	24	462-03H11-24
37353*	12"	6-1/4"	1-5/8"	20	462-03H09-20
37352*	12"	6-1/4"	2-7/8"	12	462-03H05-12A
37351*	12"	6-1/4"	3-5/8"	10	462-03H04-10A
37364	12"	8-1/8"	1"	24	462-11V03-24
37360	12"	8-1/8"	1-1/4"	20	462-09V03-20
37356	12"	8-1/8"	2-3/4"	10	462-04V03-10A
37350*	12"	12-3/4"	1-1/4"	12	462-02H11-12
37349*	12"	12-3/4"	1-5/8"	10	462-02H09-10
37348*	12"	12-3/4"	2-7/8"	6	462-02H05-6A
37347*	12"	12-3/4"	3-5/8"	5	462-02H04-5A
37363	12"	16-5/8"	1"	12	462-11V02-12
37359	12"	16-5/8"	1-1/4"	10	462-09V02-10
37355	12"	16-5/8"	2-3/4"	5	462-04V02-5A

Available with 37455 bottom foam, 37450 ESD Handles, and 37459 wire frame.

Inside Box Dimensions: 22-7/8" x 12-7/8" x 15-1/4"					
37515 Series	Cell Size			# of Cells Per Box	Reference #
Part #	Length	Width	Thickness		
37281	15-1/4"	4-3/4"	1"	40	445-09V05-40
37277	15-1/4"	4-3/4"	2-1/4"	20	445-04V05-20A
37273*	15-1/4"	5-3/16"	1-5/8"	24	445-03H11-24
37272*	15-1/4"	5-3/16"	3-5/8"	12	445-03H05-12A
37280	15-1/4"	6-1/2"	1"	30	445-09V04-30
37276	15-1/4"	6-1/2"	2-1/4"	15	445-04V04-15A
37279	15-1/4"	10"	1"	20	445-09V03-20
37275	15-1/4"	10"	2-1/4"	10	445-04V03-10A
37271*	15-1/4"	10-3/4"	1-5/8"	12	445-02H11-12
37270*	15-1/4"	10-3/4"	3-5/8"	6	445-02H05-6A
37278	15-1/4"	20-1/8"	1"	10	445-09V02-10
37274	15-1/4"	20-1/8"	2-1/4"	5	445-04V02-5A

Available with 37453 bottom foam, 37450 ESD Handles, and 37457 wire frame.

Inside Box Dimensions: 18-3/8" x 12-3/8" x 18-3/4"					
37505 Series	Cell Size			# of Cells Per Box	Reference #
Part #	Length	Width	Thickness		
37192	18-3/4"	16-1/4"	2-1/4"	5	405-04V02-5A

Available with 37454 bottom foam, 37450 ESD Handles, and 37458 wire frame.

Inside Box Dimensions: 22-7/8" x 12-7/8" x 12-5/8"					
37504 Series	Cell Size			# of Cells Per Box	Reference #
Part #	Length	Width	Thickness		
37191	12-5/8"	4-3/4"	1"	40	404-09V05-40
37187	12-5/8"	4-3/4"	2-1/4"	20	404-04V05-20A
37183*	12-5/8"	5-3/16"	1-5/8"	24	404-03H11-24
37182*	12-5/8"	5-3/16"	3-5/8"	12	404-03H05-12A
37190	12-5/8"	6-1/2"	1"	30	404-09V04-30
37186	12-5/8"	6-1/2"	2-1/4"	15	404-04V04-15A
37189	12-5/8"	10"	1"	20	404-09V03-20
37185	12-5/8"	10"	2-1/4"	10	404-04V03-10A
37181*	12-5/8"	10-3/4"	1-5/8"	12	404-02H11-12
37180*	12-5/8"	10-3/4"	3-5/8"	6	404-02H05-6A
37188	12-5/8"	20-1/8"	1"	10	404-09V02-10
37184	12-5/8"	20-1/8"	2-1/4"	5	404-04V02-5A

Available with 37453 bottom foam, 37450 ESD Handles, and 37457 wire frame.

Inside Box Dimensions: 18-5/8" x 15" x 14"					
37526 Series	Cell Size			# of Cells Per Box	Reference #
Part #	Length	Width	Thickness		
37380	14"	4"	1-1/4"	40	464-09V05-40
37376	14"	4"	2-3/4"	20	464-04V05-20A
37379	14"	5-3/8"	1-1/4"	30	464-09V04-30
37375	14"	5-3/8"	2-3/4"	15	464-04V04-15A
37372*	14"	6-1/4"	1-1/4"	24	464-03H11-24
37371*	14"	6-1/4"	1-5/8"	20	464-03H09-20
37370*	14"	6-1/4"	2-7/8"	12	464-03H05-12A
37369*	14"	6-1/4"	3-5/8"	10	464-03H04-10A
37382	14"	8-1/8"	1"	24	464-11V03-24
37378	14"	8-1/8"	1-1/4"	20	464-09V03-20
37374	14"	8-1/8"	2-3/4"	10	464-04V03-10A
37368*	14"	12-3/4"	1-1/4"	12	464-02H11-12
37367*	14"	12-3/4"	1-5/8"	10	464-02H09-10
37366*	14"	12-3/4"	2-7/8"	6	464-02H05-6A
37365*	14"	12-3/4"	3-5/8"	5	464-02H04-5A
37381	14"	16-5/8"	1"	12	464-11V02-12
37373	14"	16-5/8"	2-3/4"	5	464-04V02-5A
37377	14"	16-5/8"	1-1/4"	10	464-09V02-10

Available with 37455 bottom foam, 37450 ESD Handles, and 37459 wire frame.



- * ESD handles included
- These items made to order





In-Plant Handlers

Accessories

Steel wire perimeter reinforcing frame for extra strength and durability

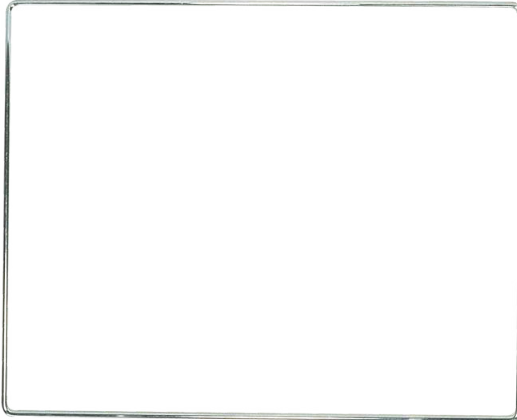

Item	Description	Size
37458	Wire Frame, 45	3/16" x 12-1/2" x 18-11/16"
37457	Wire Frame, 44	3/16" x 12-3/4" x 23-1/8"
37456	Wire Frame, 43	3/16" x 13-1/4" x 17-1/4"
37459	Wire Frame, 46	1/4" x 15-1/4" x 18-15/16"

Permanently static dissipative crosslink bottom foam for cushioning



Item	Description	Size
37451	Bottom Foam, 42	1/4" x 9-3/4" x 16-3/4"
37453	Bottom Foam, 44	1/4" x 12-1/4" x 22-5/8"
37454	Bottom Foam, 45	1/4" x 12-1/2" x 18-1/2"
37452	Bottom Foam, 43	1/4" x 12-5/8" x 16-5/8"
37455	Bottom Foam, 46	1/4" x 14-3/4" x 18-3/8"

Conductive Plastic Handles



Item	Description	Size
37450	ESD Handles, set of 2	1" x 4"

Dissipative Document Holder



Item	Description	Size
47515	Dissipative Doc. Holder	1-1/2" x 4-1/2"
47516	Dissipative Doc. Holder	6-3/8" x 8-5/8"
47517	Dissipative Doc. Holder	4-1/2" x 6-1/2"
47518	Dissipative Doc. Holder	4" x 2"
47519	Dissipative Doc. Holder	4" x 5"





Adjustable In-Plant Handlers

FEATURES

- Meets ANSI/ESD S20.20 and Packaging Standard ANSI/ESD S541
- Overall 4" box size: 21-7/8" x 18-7/8" x 4-1/4"
Overall 8" box size: 22" x 18 - 7/8" x 8"
- Maximum adjustability. Up to 30 combinations using the same storage container, lid, and partitions
- Provides ESD and physical protection for ESD sensitive circuit boards and components; with lid in place, shielding creates "Faraday Cage" restricting electrostatic charges to exterior to ship or store ESD sensitive items outside an ESD protected area (Ref: ANSI/ESD S541)
- Impregnated corrugated material; greater durability than coated or printed material - details on [page 4](#)
- Great container for Kanban
- Static dissipative surface of 1×10^6 to $< 1 \times 10^9$ ohms
- Made in the United States of America

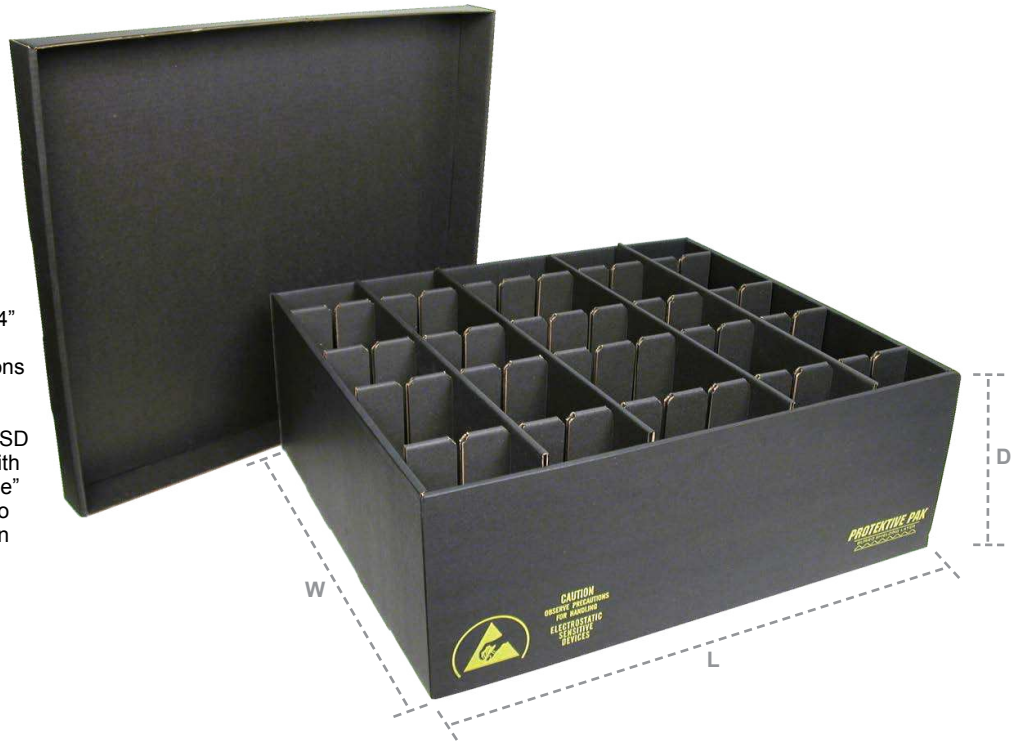

NOTE: Lid is included for all Inplant Handlers

Part #	Cell Size - L x W x T	# of Cells	Part #	Cell Size - L x W x T	# of Cells	Part #	Cell Size - L x W x T	# of Cells	Part #	Cell Size - L x W x T	# of Cells
38700	4" x 1-3/4" x 1"	150	38715	4" x 11-3/4" x 1"	15	38801	8" x 1-3/4" x 1"	150	38816	8" x 11-3/4" x 1"	15
38701	4" x 1-3/4" x 2-1/4"	70	38716	4" x 11-3/4" x 2-1/4"	7	38802	8" x 1-3/4" x 2-1/4"	70	38817	8" x 11-3/4" x 2-1/4"	7
38702	4" x 1-3/4" x 3-1/2"	50	38717	4" x 11-3/4" x 3-1/2"	5	38803	8" x 1-3/4" x 3-1/2"	50	38818	8" x 11-3/4" x 3-1/2"	5
38703	4" x 3-3/4" x 1"	75	38718	4" x 13-3/4" x 1"	15	38804	8" x 3-3/4" x 1"	75	38819	8" x 13-3/4" x 1"	15
38704	4" x 3-3/4" x 2-1/4"	35	38719	4" x 13-3/4" x 2-1/4"	7	38805	8" x 3-3/4" x 2-1/4"	35	38820	8" x 13-3/4" x 2-1/4"	7
38705	4" x 3-3/4" x 3-1/2"	25	38720	4" x 13-3/4" x 3-1/2"	5	38806	8" x 3-3/4" x 3-1/2"	25	38821	8" x 13-3/4" x 3-1/2"	5
38706	4" x 5-3/4" x 1"	45	38721	4" x 15-3/4" x 1"	15	38807	8" x 5-3/4" x 1"	45	38822	8" x 15-3/4" x 1"	15
38707	4" x 5-3/4" x 2-1/4"	21	38722	4" x 15-3/4" x 2-1/4"	7	38808	8" x 5-3/4" x 2-1/4"	21	38823	8" x 15-3/4" x 2-1/4"	7
38708	4" x 5-3/4" x 3-1/2"	15	38723	4" x 15-3/4" x 3-1/2"	5	38809	8" x 5-3/4" x 3-1/2"	15	38824	8" x 15-3/4" x 3-1/2"	5
38709	4" x 7-3/4" x 1"	30	38724	4" x 17-3/4" x 1"	15	38810	8" x 7-3/4" x 1"	30	38825	8" x 17-3/4" x 1"	15
38710	4" x 7-3/4" x 2-1/4"	14	38725	4" x 17-3/4" x 2-1/4"	7	38811	8" x 7-3/4" x 2-1/4"	14	38826	8" x 17-3/4" x 2-1/4"	7
38711	4" x 7-3/4" x 3-1/2"	10	38726	4" x 17-3/4" x 3-1/2"	5	38812	8" x 7-3/4" x 3-1/2"	10	38827	8" x 17-3/4" x 3-1/2"	5
38712	4" x 9-3/4" x 1"	30	38727	4" x 19-3/4" x 1"	15	38813	8" x 9-3/4" x 1"	30	38828	8" x 19-3/4" x 1"	15
38713	4" x 9-3/4" x 2-1/4"	14	38728	4" x 19-3/4" x 2-1/4"	7	38814	8" x 9-3/4" x 2-1/4"	14	38829	8" x 19-3/4" x 2-1/4"	7
38714	4" x 9-3/4" x 3-1/2"	10	38729	4" x 19-3/4" x 3-1/2"	5	38815	8" x 9-3/4" x 3-1/2"	10	38830	8" x 19-3/4" x 3-1/2"	5

**THE MOST ACCURATE AND FASTEST METHOD TO PROCESS YOUR ORDER IS TO PLACE IT ONLINE THROUGH OUR WEB SITE.
THE BENEFITS OF ORDERING ONLINE INCLUDE:**

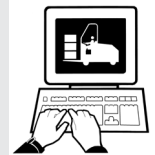

- No minimum order amount for online orders
- Your order is expedited directly to shipping. Online orders are prioritized and will be processed first and we will endeavor to ship in-stock items within 24 hours of the time received. (On average on-line orders are processed and shipped 1 business day faster than paper orders)
- Error Free - You place your order correctly the first time - no keying errors on our side
- Use a Purchase Order or Credit Card
- Order can be shipped Prepay & Add or Collect
- Order using real-time pricing and availability on any item - any time
- Check order status online and access your order history and invoices

ProtektivePak.com





Storage Containers



Lid sold separately



Part #	Description	Size
37550	Lid	17-3/4" x 10-3/4" x 2-1/8"
37551	Lid	17-7/8" x 13-5/8" x 2-1/8"
37553	Lid	19-1/16" x 13-1/8" x 2-1/8"
37554	Lid	19-3/8" x 15-3/4" x 2-1/8"
37557	Lid	22-1/2" X 19-3/4" X 2"
37552	Lid	23-1/2" x 13-3/8" x 2-1/8"

FEATURES

- Meets ANSI/ESD S20.20 and Packaging Standard ANSI/ESD S541
- Available with optional lid; provides ESD and physical protection for ESD sensitive components; with lid in place, shielding creates "Faraday Cage" restricting electrostatic charges to exterior to ship or store ESD sensitive items outside an ESD protected area (Ref: ANSI/ESD S541)
- Steel reinforcing wire frame for additional strength and durability, ESD handles, and permanently static dissipative bottom foam pad for cushioning
- Impregnated corrugated material; greater durability than coated or printed material
- Constructed with double sides, double (boxes under 6" deep) or triple (boxes over 6" deep) ends, and single (boxes under 6" deep) or double (boxes over 6" deep) thickness bottom for greater durability
- Static dissipative surface of 1×10^6 to $< 1 \times 10^9$ ohms - minimizing the potential of rapid discharge or sparking
- Buried shielding layer, minimizing the potential of sloughing and rub-off contamination
- Made from 100% recycled material, and is 100% recyclable
- No tooling costs; easy assembly without the need for tape, glue, or staples
- Reusable, ensuring low cost
- Made in the United States of America

Part #	REF#	Box Size - L x W x D*	Handles†	Lid†	Wire†	Foam†
37508	411-BX	16-7/8" x 10" x 3-1/2"	N/A	37550	N/A	37451
37501	401-BX	16-7/8" x 10" x 5-3/8"	N/A	37550	N/A	37451
37509	422-BX	17" x 9-7/8" x 2-1/2"	N/A	37550	N/A	37451
37500	400-BX	17" x 9-7/8" x 7-1/4"	37450	37550	N/A	37451
37512	438-BX	17" x 13" x 8-3/4"	37450	37551	37456	37452
37520	456-BX	18-3/8" x 12-3/8" x 6-3/4"	37450	37553	37458	37454
37505	405-BX	18-1/2" x 12-3/8" x 18-3/4"	37450	37553	37458	37454
37506	406-BX	18-5/8" x 15" x 5-7/8"	37450	37554	37459	37455
37527	468-BX	18-5/8" x 15" x 8"	37450	37554	37459	37455
37524	460-BX	18-5/8" x 15" x 10"	37450	37554	37459	37455
37525	462-BX	18-5/8" x 15" x 12"	37450	37554	37459	37455
37526	464-BX	18-5/8" x 15" x 14"	37450	37554	37459	37455
37530		21-7/8" x 18-7/8" x 4-1/4"		37557		
37532		22" X 18-7/8" X 8"		37557		
37516	446-BX	22-7/8" x 12-7/8" x 6"	37450	37552	37457	37453
37517	448-BX	22-7/8" x 12-7/8" x 8"	37450	37552	37457	37453
37514	440-BX	22-7/8" x 12-7/8" x 10"	37450	37552	37457	37453
37504	404-BX	22-7/8" x 12-7/8" x 12-5/8"	37450	37552	37457	37453
37515	445-BX	22-7/8" x 12-7/8" x 15-1/4"	37450	37552	37457	37453

* Inside Dimension
† Sold Separately
• These items made to order

Download Drawing [37500](#)

See [page 9](#) for accessories.





Small Component Shippers

FEATURES

- Meets ANSI/ESD S20.20 and Packaging Standard ANSI/ESD S541
- Efficient means of shipping small ESD sensitive items
- Provides ESD shielding with lid closed; "Faraday Cage" effect restricts electrostatic charges to exterior of box
- For physical protection; foam cushioning reduces stress from physical shock
- Pink static dissipative foam (1/2" thick) laminated to top, and conductive crosslink black polyethylene foam (1/4" thick) in bottom (other foam options available)
- Conductive crosslink black polyethylene cushion grade foam (3/8" thick, Rv < 10⁴ ohms) laminated to top, and conductive crosslink black polyethylene pin insertion grade foam (1/4" thick, Rv < 10⁴ ohms) in bottom (All dimensions are ± 1/16")
- All Protektive Pak corrugated features as shown on [page 4](#)
- Made in America



Download Drawing [39508](#) and [37000](#)

Part #	Size I.D. - L x W x D
39508	2-1/2" x 1-1/4" x 1"
39536	3-7/16" x 2-1/8" x 1"
39542	3-3/4" x 3-3/4" x 1"
39550	7" x 3-1/2" x 1"

These items: black foam top and black foam bottom

Part #	Size I.D. - L x W x D
37000	2-1/2" x 1-1/4" x 1"
37008	2-3/4" x 2-3/4" x 1"
37001	3-1/2" x 1-1/4" x 1"
37003	3-7/16" x 2-1/8" x 1"
37004	3-3/4" x 3-3/4" x 1"
37006	4-1/8" x 3-1/16" x 1"

These items: pink foam top and black foam bottom

Part #	Size I.D. - L x W x D
37009	4-3/8" x 4-3/8" x 1"
37002	4-1/2" x 1-1/4" x 1"
37010	4-1/2" x 3-3/4" x 1"
37007	5-1/4" x 1-1/4" x 1"
37005	7" x 3-1/2" x 1"
37011	12-7/8" x 4" x 1"

These items: pink foam top and black foam bottom



Circuit Board Shippers

FEATURES

- Meets ANSI/ESD S20.20 and Packaging Standard ANSI/ESD S541
- Efficient means of shipping ESD sensitive circuit boards and other items
- For physical protection, convoluted foam secures items, minimizing movement and reduces stress from physical shock
- Choice of static dissipative polyurethane PINK foam or low density conductive convoluted BLACK foam
- All Protektive Pak corrugated features as shown on [page 4](#)
- Made in the United States of America

Download Drawing [37033](#) and [37050](#)

Part #	Size I.D. - L x W x D
37033	7" x 5" x 1-1/2", w/black foam
37034	7" x 5" x 2-1/2", w/black foam
37035	10-1/2" x 8-1/2" x 1-1/2", w/black foam
37036	10-1/2" x 8-1/2" x 2-1/2", w/black foam
37037	12-1/2" x 10-1/2" x 2-1/2", w/black foam



Part #	Size I.D. - L x W x D
37050	4" x 4" x 2-1/8", box only
37051	4" x 4" x 2-1/8", w/pink foam
37080	6-3/16" x 6" x 1-1/2", box only
37081	6-3/16" x 6" x 1-1/2", w/pink foam
37052	7" x 5" x 1-1/2", box only
37053	7" x 5" x 1-1/2", w/pink foam
37054	7" x 5" x 2-1/2", box only
37055	7" x 5" x 2-1/2", w/pink foam
37082	7" x 7" x 1-1/2", box only
37083	7" x 7" x 1-1/2", w/pink foam
37056	9" x 7-1/2" x 2-1/2", box only
37057	9" x 7-1/2" x 2-1/2", w/pink foam
37084	9" x 9" x 1-1/2", box only
37085	9" x 9" x 1-1/2", w/pink foam
37058	10-1/2" x 8-1/2" x 1-1/2", box only

Part #	Size I.D. - L x W x D
37059	10-1/2" x 8-1/2" x 1-1/2", w/pink foam
37060	10-1/2" x 8-1/2" x 2-1/2", box only
37061	10-1/2" x 8-1/2" x 2-1/2", w/pink foam
37062	12-1/2" x 10-1/2" x 1-1/2", box only
37063	12-1/2" x 10-1/2" x 1-1/2", w/pink foam
37064	12-1/2" x 10-1/2" x 2-1/2", box only
37065	12-1/2" x 10-1/2" x 2-1/2", w/pink foam
37066	14-7/8" x 6-5/8" x 2", box only
37067	14-7/8" x 6-5/8" x 2", w/pink foam
37068	15-1/2" x 12-1/2" x 1-1/2", box only
37069	15-1/2" x 12-1/2" x 1-1/2", w/pink foam
37070	15-1/2" x 12-1/2" x 2-1/2", box only
37071	15-1/2" x 12-1/2" x 2-1/2", w/pink foam
37072	16" x 12-1/4" x 3-1/2", box only
37073	16" x 12-1/4" x 3-1/2", w/pink foam

Part #	Size I.D. - L x W x D
37086	16" x 15" x 3", box only
37087	16" x 15" x 3", w/pink foam
37074	18-7/8" x 17-5/8" x 1-3/4", box only
37075	18-7/8" x 17-5/8" x 1-3/4", w/pink foam
37088	19" x 19" x 3", box only
37089	19" x 19" x 3", w/pink foam
37076	20-1/2" x 15-1/2" x 1-1/2", box only
37077	20-1/2" x 15-1/2" x 1-1/2", w/pink foam
37078	20-1/2" x 15-1/2" x 2-1/2", box only
37079	20-1/2" x 15-1/2" x 2-1/2", w/pink foam
37090	22" x 15" x 3", box only
37091	22" x 15" x 3", w/pink foam
37092	27-3/8" x 24-3/8" x 4", box only
37093	27-3/8" x 24-3/8" x 4", w/pink foam

• These items made to order





Impregnated Corrugated Trays

Superior Material Handling of Unsoldered Populated Boards

Replace wooden and on-edge circuit board racks; superior for transporting boards to wave solder machine:

- Meets ANSI/ESD S20.20 and Packaging Standard ANSI/ESD S541
- Permanently static dissipative foam (shuntable) laminated to our impregnated corrugated material
- Horizontally store and transport populated but unsoldered circuit boards, not susceptible to knocking over boards
- Get better ESD protection, insert leads into permanently static dissipative shuntable foam, achieve equipotential between leads
- As recommended by ESD Association, Packaging materials that are in intimate contact with devices should be dissipative.
- All Protektive Pak impregnated corrugated features as shown on [page 4](#)

Board Handler Trays

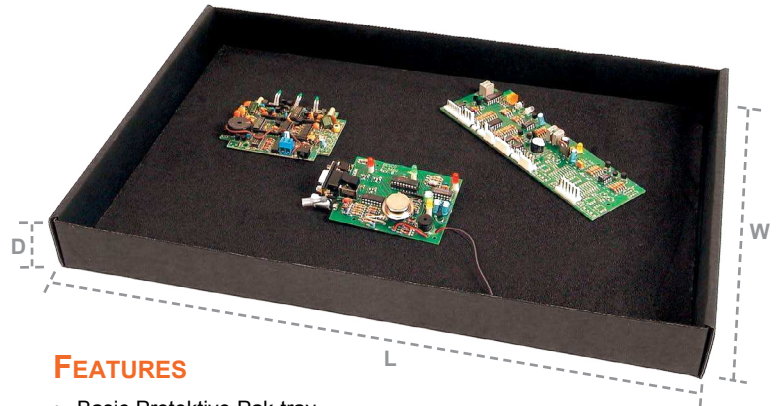

FEATURES

- Basic Protektive Pak tray
- Great container for Kanban
- Made in the United States America

Download Drawing [37650](#)

Part #	Size I.D. - L x W x D
37650	17-3/4" x 10-3/4" x 2-1/8"
37651	17-7/8" x 13-5/8" x 2-1/8"
37653	19-1/4" x 13-1/8" x 2-1/8"
37654	19-3/8" x 15-3/4" x 2-1/8"
37652	23-1/2" x 13-3/8" x 2-1/8"

Super Tek-Trays



Yellow Wire Corner

FEATURES

- Trays stack together, improving productivity and saving valuable space
- Yellow stacking wire is easy to see and helps provide visual identification
- Used to transport or store ESD sensitive items
- Made in the United States of America

Download Drawing [37760](#)

Part #	Size I.D. - L x W x D
37760	18" x 11-3/8" x 1-3/4", with yellow wire corners
37761	22-3/4" x 17-1/2" x 2-1/2", with yellow wire corners
37762	18" x 11-3/8" x 1-3/4", with plastic corners
37763	22-3/4" x 17-1/2" x 2-1/2", with plastic corners

Tek-Trays™

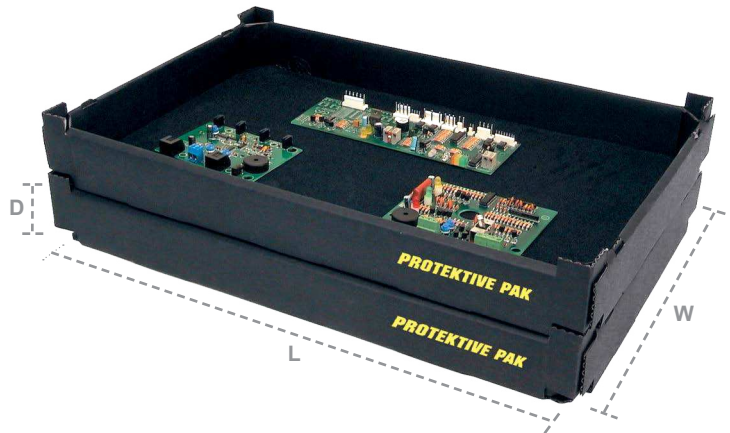

FEATURES

- Trays that can stack and nest together for improved use of space
- Great container for Kanban
- Made in the United States of America

Download Drawing [37750](#)

Part #	Size I.D. - L x W x D
37750	18" x 11-3/8" x 1-3/4"
37751	22-7/8" x 17-1/4" x 2-3/4"





Mini Tek-Tray

FEATURES

- Compact trays stack and nest together, improving productivity and saving valuable space
- Used to transport or store ESD sensitive items
- Static dissipative foam (Rs 1×10^6 to $< 1 \times 10^8$ ohms) laminated to bottom
- Made in the United States of America



Part #	Size I.D. - L x W x D
37752	12" x 8-5/8" x 1-3/4"

Tek-Tray Partition Set

FEATURES

- Partitions are adjustable for different size parts
- Impregnated corrugated material; greater durability than coated or printed material
- Static dissipative surface of 1×10^6 to $< 1 \times 10^9$ ohms
- Made from 100% recycled material, and is 100% recyclable
- Reusable, ensuring best value
- Made in the United States of America

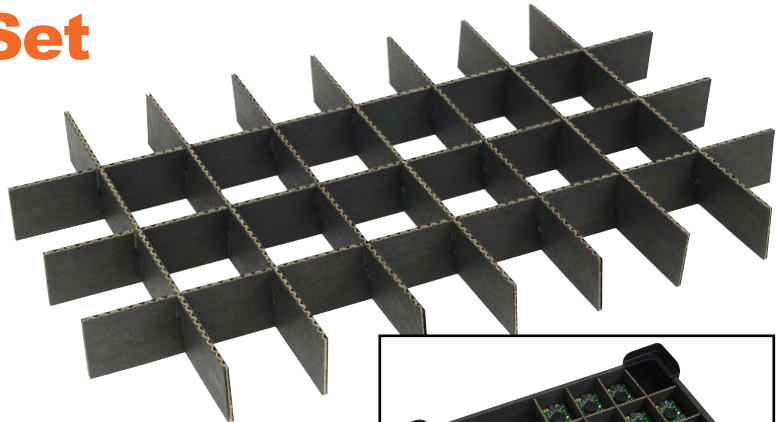

Part #	Description
37764	Partition set for 37750, 37760, 37762
37765	Partition set for 37751, 37761, 37763

Tek-Tray Drop-In Lid

FEATURES

- Finger notches in lid for easy lifting
- Constructed of impregnated corrugated material for greater durability
- Static dissipative surface of 1×10^6 to $< 1 \times 10^9$ ohms
- Buried shielding layer minimizes the potential of sloughing and abrasion contamination
- Made from 100% recycled material, and is 100% recyclable
- Made in the United States of America



Part #	Description
37766	Lid for 37750
37767	Lid for 37760 & 37762
37768	Lid for 37751
37769	Lid for 37761 & 37763





Tek-Mate™ Board Handlers

FEATURES

- Meets ANSI/ESD S20.20 and Worksurface Standard ANSI/ESD S4.1
- Portable ESD worksurface that can also be used to transport populated, unsoldered circuit boards
- Static dissipative foam (Rtt 1 x 10⁶ to 1 x 10⁹ ohms) laminated to Protektive Pak® impregnated corrugated material for greater durability
- Foam is shuntable, component leads can be kept at equipotential and are more stable when moved
- Includes 10mm (3/8") grounding snap
- Made in the United States of America

Download Drawing [37800](#)

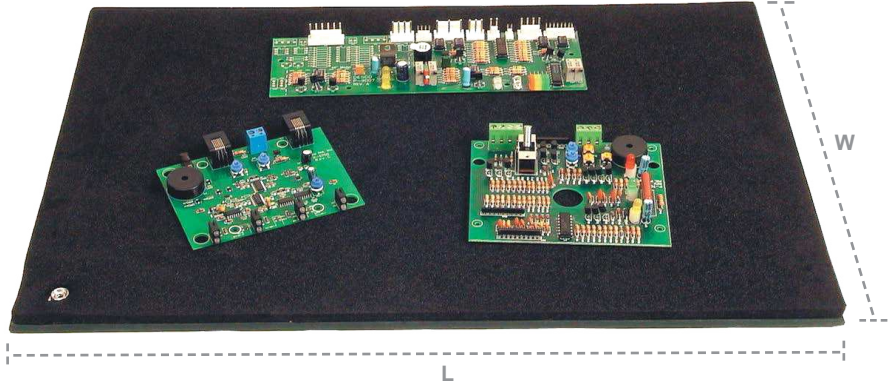

Part #	Size - L x W	Snap
37800	12" x 18"	Male
39852	12" x 18"	Female
37801	18" x 24"	Male
39854	18" x 24"	Female

Pro Mats™

FEATURES

- Meets ANSI/ESD S20.20 and Worksurface Standard ANSI/ESD S4.1
- Economical ESD worksurface
- Antistatic, low charging dissipative surface
- Includes two 10 mm (3/8") male or female grounding snaps
- Chemical resistant
- Great choice for shelves and transportation carts
- Impregnated corrugated material; greater durability
- Static dissipative surface of 1 x 10⁶ to < 1 x 10⁹ ohms
- Made in the United States of America

Download Drawing [37670](#)



Part #	Size I.D. - L x W x Th	Snap
37670	11-3/4" x 35-1/2" x 1/16"	Male
39780	11-3/4" x 35-1/2" x 1/16"	Female
37671	11-3/4" x 47-1/2" x 1/16"	Male
39784	11-3/4" x 47-1/2" x 1/16"	Female
37672	11-3/4" x 59-1/2" x 1/16"	Male
39787	11-3/4" x 59-1/2" x 1/16"	Female
37673	17-1/2" x 35-1/2" x 1/16"	Male
39792	17-1/2" x 35-1/2" x 1/16"	Female
37676	23-1/2" x 35-1/2" x 1/16"	Male
39858	23-1/2" x 35-1/2" x 1/16"	Female
37674	23-1/2" x 47-1/2" x 1/16"	Male
39796	23-1/2" x 47-1/2" x 1/16"	Female
37675	23-1/2" x 59-1/2" x 1/16"	Male
39800	23-1/2" x 59-1/2" x 1/16"	Female



Make sure to visit ProtektivePak.com for the latest up to date information including new products, promotions and technical information.

See our products being
Made in America
on our web site:

ProtektivePak.com/factory





Open Bin Boxes

FEATURES

- Meets ANSI/ESD S20.20 and Packaging Standard ANSI/ESD S541
- Economical method of storing static sensitive electronic devices
- Wide choice of sizes
- Shipped knocked-down; easy to assemble
- All Protektive Pak corrugated features as shown on [page 6](#)
- Made in the United States of America

Download Drawing [37100](#)

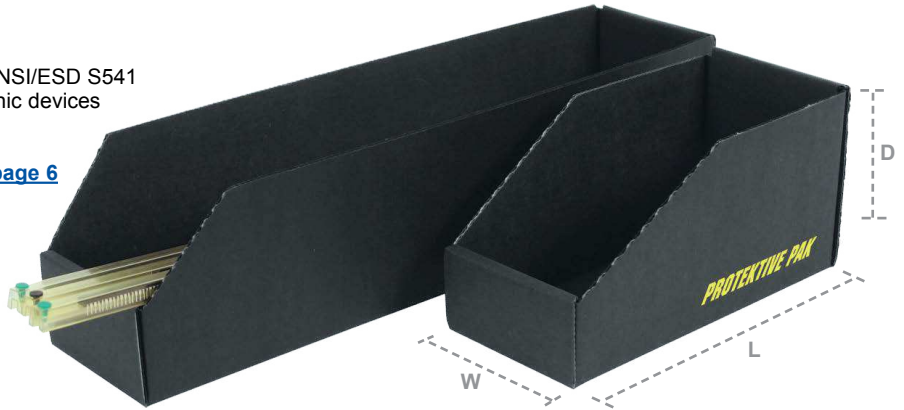

Part #	Size O.D. - L x W x D
37100	5-3/4" x 3-3/4" x 2-11/16"
37101	9" x 4" x 4-1/2"
37102	12" x 2" x 4-1/2"
37103	12" x 4" x 4-1/2"
37104	12" x 6" x 4-1/2"
37105	12" x 8" x 4-1/2"
37106	12" x 12" x 4-1/2"
37115	18" x 2" x 4-1/2"
37107	18" x 4" x 4-1/2"
37108	18" x 6" x 4-1/2"
37109	18" x 8" x 4-1/2"
37110	18" x 12" x 4-1/2"
37117	24" x 12" x 6-3/8"
37116	24-3/4" x 2-1/4" x 4-1/2"
37111	24-3/4" x 4-1/4" x 4-1/2"
37112	24-3/4" x 6-1/4" x 4-1/2"
37113	24-3/4" x 8-1/4" x 4-1/2"
37114	24-3/4" x 12" x 4-1/2"

- 37100 is a sub-bin designed to create smaller bin space with part numbers 37103, 37107, and 37111

Make sure to visit ProtektivePak.com for the latest up to date information including new products, promotions and technical information.

Closed Bin Boxes

FEATURES

- Meets ANSI/ESD S20.20 and Packaging Standard ANSI/ESD S541
- Economical method of storing static sensitive electronic devices
- Wide choice of sizes
- When reclosable cover is closed, the "Faraday Cage" effect restricts electrostatic charges to exterior of box
- Shipped knocked-down; easy to assemble

- Made in the United States of America

Download Drawing [37590](#)

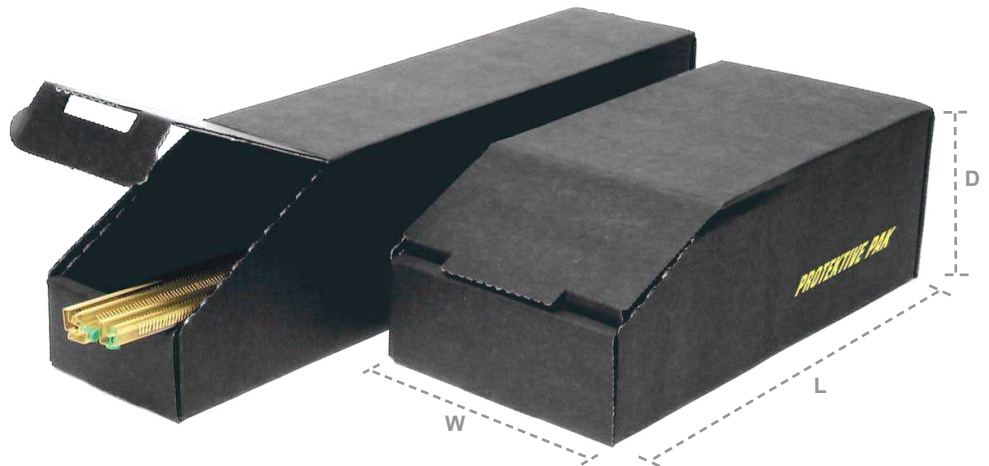

Part #	Size O.D. - L x W x D
37590	12" x 4" x 4-1/2"
37591	12" x 6" x 4-1/2"
37599	12" x 8" x 4-1/2"
37592	12" x 12" x 4-1/2"
37593	18" x 4" x 4-1/2"
37594	18" x 6" x 4-1/2"
37598	24-3/4" x 2" x 4-1/2"
37595	24-3/4" x 4" x 4-1/2"
37596	24-3/4" x 6" x 4-1/2"
37597	24-3/4" x 8" x 4-1/2"

- This item is made to order





Reel/Dip Tube Bin Boxes

FEATURES

- Meets ANSI/ESD S20.20 and Packaging Standard ANSI/ESD S541
- Designed to safely store both reels and Rail/DIP tubes in the same bin box
- Available in open style with better loading from above
- Available in closed style with better loading from front
- May be used for storing, kitting, or transporting during work-in-process operations
- Shipped knocked-down; easy to assemble
- All Protective Pak corrugated features as shown on [page 6](#)
- Made in the United States of America

Download Drawing [37130](#)

Part #	Size O.D. - L x W x D
37130	Open: 18" x 2" x 9"
37132	Open: 18" x 4" x 9"
37134	Open: 18" x 6" x 9"
37131	Open: 24" x 2" x 9"
37133	Open: 24" x 4" x 9"
37135	Open: 24" x 6" x 9"

Part #	Size O.D. - L x W x D
37610	Closed: 24-3/8" x 2-11/16" x 15-1/4"
37611	Closed: 24-3/8" x 4-11/16" x 15-1/4"



Reel Storage Containers

FEATURES

- Meets ANSI/ESD S20.20 and Packaging Standard ANSI/ESD S541
- Economical method of storing reels
- Containers 37560 - 37562 include conductive plastic handles and removable lids
- Containers 37563- 37567 include identification labels
- Constructed with double side partitions for greater durability
- Conductive plastic indexing ribs prevent the reels from rolling around when stored
- All Protective Pak corrugated features as shown on [page 6](#)
- Made in the United States of America

Download Drawing [37561](#)

Part #	Size O.D. - L x W x D
37561	12" x 7-1/4" x 7-1/4", 7" Reel, includes lid and handles
37560	13-1/2" x 12" x 13-1/4", 13" Reel, includes lid and handles
37562	20" x 7-1/4" x 7-1/4", 7" Reel, includes lid and handles

Part #	Size O.D. - L x W x D
37566	5-3/4" x 8-1/4" x 7-1/4", Reel 7", 5 Slots
37567	5-3/4" x 13-11/16" x 13-1/4", Reel 13", 15 Slots
37563	17-1/2" x 8-1/4" x 7-1/4", Reel 7", 15 Slots
37564	17-1/2" x 13-11/16" x 13-1/4", Reel 13", 15 Slots
37565	17-1/2" x 15-5/8" x 15-1/4", Reel 15", 15 Slots

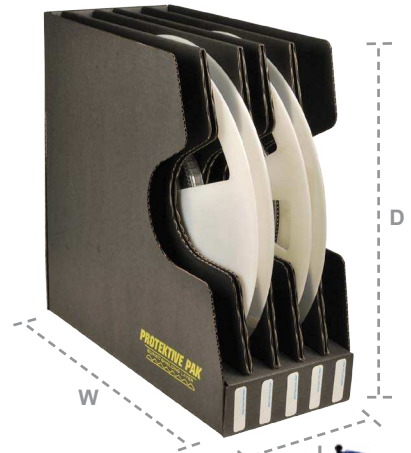



Universal Organizers

FEATURES

- Meets ANSI/ESD S20.20 and Packaging Standard ANSI/ESD S541
- Increases productivity by organizing and standardizing bottle and tool placement at the workstation
- Aesthetically improves the appearance of the work area
- Includes openings for bottles, wipes and hand tools
- Includes ESD safe swab holder insert and cover for wipes
- All Protektive Pak corrugated features as shown on [page 6](#) (item 47553) and Protektive Pak Plastek features as shown on [page 20](#) (item 47554)
- Made in the United States of America

Download Drawing [47553](#) and [47554](#)



Part #	Size O.D. - L x W x D
47553	Universal Organizer, Corrugated, 16-7/8" x 8-1/8" x 2-3/8"
47554	Universal Organizer, Plastek, 16-7/8" x 8-1/8" x 2-3/8"

Compact Workstation Organizer

FEATURES

- Meets ANSI/ESD S20.20 and Packaging Standard ANSI/ESD S541
- Compact, convenient size for organizing and standardizing tool and bottle placement at the workstation
- Aesthetically improves the appearance of the work area
- Includes openings for bottles, holes hand tools, swabs, miscellaneous items
- Marked with ESD Protective symbol per ANSI/ESD S541
- Conductive 1×10^2 to $< 1 \times 10^5$ ohm material provides reliable path-to-ground
- Made in the United States of America

Download Drawings [47555](#) and [47556](#)

Part #	Size O.D. - L x W x D
47555	Compact Organizer, Corrugated, 11-1/4" x 8" x 2-1/4"
47556	Compact Organizer, Plastek, 11-1/4" x 8" x 2-1/4"



Static Dissipative Tool Carrier and Lid

FEATURES

- Open design allows for quick access to tools and accessories
- Includes 6 versatile, multiuse compartments 4 each (2-3/4" x 2-3/4") and 2 each (5-3/4" x 5-3/4")
- Easy assembly, no need to tape, glue, or staples
- Marked with ESD protective symbol per ANSI/ESD S541
- Static Dissipative surface 1×10^6 to $< 1 \times 10^9$ ohms per ANSI/ESD STM11.11 - electrostatic charges removed when grounded
- Impregnated Corrugated material - superior material with greater durability than painted material
- Made from 100% Recycled material and is 100% recyclable
- Custom configurations available
- Optional lid [47558](#) sold separately
- All Protektive Pak corrugated features as shown on [page 6](#)
- Made in the United States of America

Download Drawing [47557](#)

Part #	Description
47557	Static Dissipative Tool Carrier
47558	Tool Carrier Lid



See our products being
Made in America
on our web site:
ProtektivePak.com/factory



ESD Dissipative Turntable



FEATURES

- Ideal for working on heavier assemblies in an EPA - [Watch our video](#)
- ESD protective for use with ESD sensitive assemblies
- Durable ¼" thick Conductive, Crosslink Polyethylene Foam
- Galvanized Steel Turntable located at the bottom
- Size: 12-1/2" Octagon (across flats)
- Very low profile - both sizes only 1" high
- Weight capacity 50 lbs / 23 Kg
- Volume Resistance 1×10^6 to $< 1 \times 10^9$ ohms per ANSI/STM11.12
- Meets worksurface required limit of ANSI/ESD S20.20 per ANSI/ESD S4.1 and ESD TR53
- Electrostatic charges removed to ground via contact on grounded ESD worksurface or via optional [47204](#) Ground Cord
- Made in the United States of America



Download Drawing [47200](#) and [47204](#)

Part #	Description
47200	ESD Dissipative Turntable, 12.5"
47201	ESD Dissipative Turntable, 15.5"
47204	Ground Cord

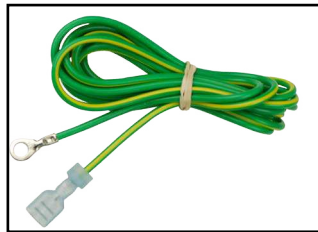

Optional Ground Cord

Trash Receptacles and Liners

FEATURES

- Meets ANSI/ESD S20.20 and Packaging Standard ANSI/ESD S541
- Economical ESD protective product to replace high charging plastic trash cans
- Antistatic, low charging dissipative surface can be grounded via ESD floor
- ESD protective liners also available
- Made in the United States of America

Download Drawings [37810](#), [37820](#), [37822](#)

Part #	Size I.D. - L x W x D
37810	13-1/2" x 12" x 13-1/4", 9 Gallon, Impregnated Corrugated (with wire & handles)
37811	13-1/2" x 12" x 13-1/4", 9 Gallon, Impregnated Corrugated (receptacle only)
37812	22-7/8" x 12-7/8" x 32", 40 Gallon, Impregnated Corrugated (with wire & handles)
37813	22-7/8" x 12-7/8" x 32", 40 Gallon, Impregnated Corrugated (receptacle only)
37814	12-1/2" x 10" x 14", 10 Gallon, Impregnated Corrugated
37816	12-1/2" x 10" x 14", 10 Gallon, Plastek
37815	21" x 12-3/4" x 28", 36 Gallon, Impregnated Corrugated
37817	21" x 12-3/4" x 28", 36 Gallon, Plastek
37820	10 Gallon Trash Liner, 26" x 24", Black, 50 per pack
37821	55 Gallon Trash Liner, 22" x 16" x 58", Black, 50 per pack
37822	10 Gallon Trash Liner, 26" x 26", Pink, 50 per pack
37823	36 Gallon Trash Liner, 36" x 40", Pink, 50 per pack





PLASTEK™ In-Plant Handlers

Lid included



Find the optimal size In-Plant Handler that you need.

See the Tek-Search on our web site:

ProtektivePak.com

Just enter the size of your circuit board assembly (length x width x thickness) and you will be provided with a list of the most efficient In-Plant Handlers.

PLASTEK™ IN-PLANT HANDLER FEATURES

- Meets ANSI/ESD S20.20 and Packaging Standard ANSI/ESD S541
- Provides physical protection with conductive material, providing reliable path-to-ground
- Many sizes available to optimize fit to your product size
- Includes static dissipative foam bottom, providing ESD and shock protection
- Includes steel wire frame for extra strength
- Conductive plastic hand holes for ease of handling, while providing reliable path-to-ground
- Static Dissipative partitions made from Protektive Pak® impregnated corrugated material
- Product ships assembled
- Great container for Kanban
- All Plastek™ features as shown below
- Rs 1×10^2 to $< 1 \times 10^5$ ohms
- Made in the United States of America

Download Drawing [38920](#)

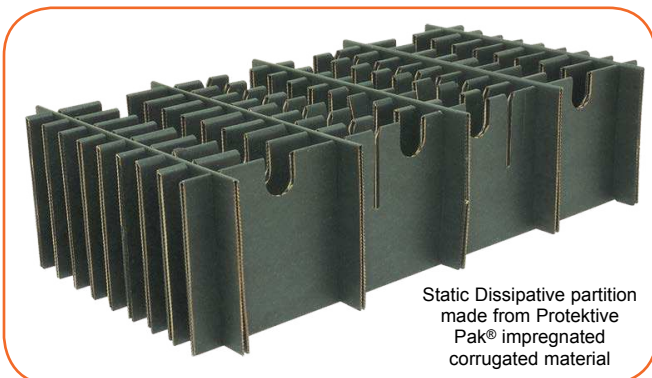

Static Dissipative partition made from Protektive Pak® impregnated corrugated material

Features of all Protektive Pak Plastek™

- Conductive 1×10^2 to $< 1 \times 10^5$ ohm material provides reliable path-to-ground
- Superior strength and durability; made from extruded, high impact polypropylene materials
- Chemical and moisture resistant
- Ideal for use where corrugated and/or paper products cannot be used
- Economical alternative to injection molded products
- Reusable, ensuring best value

All Plastek™ In-Plant Handlers include:

- Storage container
- Partition set
- Bottom foam pad
- Handles
- Lid





PLASTEK™ In-Plant Handlers

Lid is included for all In-Plant Handlers

Inside Box Dimensions: 18-5/8" x 15" x 5-7/8"					
39103 Series	Cell Size			# of Cells	Reference #
Part #	Length	Width	Thickness	Per Box	
38946	5-7/8"	4"	1-1/4"	40	CPS406-40
38943	5-7/8"	4"	2-3/4"	20	CPS406-20A
38945	5-7/8"	5-3/8"	1-1/4"	30	CPS406-30
38941	5-7/8"	5-3/8"	2-3/4"	15	CPS406-15A
38944	5-7/8"	8-1/8"	1"	24	CPS406-24
38942	5-7/8"	8-1/8"	1-1/4"	20	CPS406-20
38939	5-7/8"	8-1/8"	2-3/4"	10	CPS406-10A
38940	5-7/8"	16-5/8"	1"	12	CPS406-12
38938	5-7/8"	16-5/8"	1-1/4"	10	CPS406-10
38947	5-7/8"	16-5/8"	2-3/4"	5	CPS406-5A

Ships assembled with 37455 bottom foam.

Inside Box Dimensions: 22-7/8" x 12-7/8" x 6"					
39111 Series	Cell Size			# of Cells	Reference #
Part #	Length	Width	Thickness	Per Box	
38998	6"	4-3/4"	1"	40	CPS446-40
38996	6"	4-3/4"	2-1/4"	20	CPS446-20A
38997	6"	6-1/2"	1"	30	CPS446-30
38994	6"	6-1/2"	2-1/4"	15	CPS446-15A
38995	6"	10"	1"	20	CPS446-20
38993	6"	10"	2-1/4"	10	CPS446-10A
38992	6"	20-1/8"	1"	10	CPS446-10
38999	6"	20-1/8"	2-1/4"	5	CPS446-5A

Ships assembled with 37453 bottom foam.

Inside Box Dimensions: 17" x 13" x 6-3/4"					
39106 Series	Cell Size			# of Cells	Reference #
Part #	Length	Width	Thickness	Per Box	
38962	6-3/4"	4-5/8"	1"	30	CPS436-30
38960	6-3/4"	4-5/8"	2-3/8"	15	CPS436-15A
38961	6-3/4"	7-1/8"	1"	20	CPS436-20
38959	6-3/4"	7-1/8"	2-3/8"	10	CPS436-10A
38958	6-3/4"	14-5/8"	1"	10	CPS436-10
38963	6-3/4"	14-5/8"	2-3/8"	5	CPS436-5A

Ships assembled with 37452 bottom foam.

Inside Box Dimensions: 18-5/8" x 15" x 8"					
39122 Series	Cell Size			# of Cells	Reference #
Part #	Length	Width	Thickness	Per Box	
39070	8"	4"	1-1/4"	40	CPS468-40
39067	8"	4"	2-3/4"	20	CPS468-20A
39069	8"	5-3/8"	1-1/4"	30	CPS468-30
39065	8"	5-3/8"	2-3/4"	15	CPS468-15A
39068	8"	8-1/8"	1"	24	CPS468-24
39066	8"	8-1/8"	1-1/4"	20	CPS468-20
39063	8"	8-1/8"	2-3/4"	10	CPS468-10A
39064	8"	16-5/8"	1"	12	CPS468-12
39062	8"	16-5/8"	1-1/4"	10	CPS468-10
39071	8"	16-5/8"	2-3/4"	5	CPS468-5A

Ships assembled with 37455 bottom foam.

Inside Box Dimensions: 22-7/8" x 12-7/8" x 8"					
39112 Series	Cell Size			# of Cells	Reference #
Part #	Length	Width	Thickness	Per Box	
39006	8"	4-3/4"	1"	40	CPS448-40
39004	8"	4-3/4"	2-1/4"	20	CPS448-20A
39005	8"	6-1/2"	1"	30	CPS448-30
39002	8"	6-1/2"	2-1/4"	15	CPS448-15A
39003	8"	10"	1"	20	CPS448-20
39001	8"	10"	2-1/4"	10	CPS448-10A
39000	8"	20-1/8"	1"	10	CPS448-10
39007	8"	20-1/8"	2-1/4"	5	CPS448-5A

Ships assembled with 37453 bottom foam.

Inside Box Dimensions: 17" x 13" x 8-3/4"					
39107 Series	Cell Size			# of Cells	Reference #
Part #	Length	Width	Thickness	Per Box	
38968	8-3/4"	4-5/8"	1"	30	CPS438-30
38966	8-3/4"	4-5/8"	2-3/8"	15	CPS438-15A
38967	8-3/4"	7-1/8"	1"	20	CPS438-20
38965	8-3/4"	7-1/8"	2-3/8"	10	CPS438-10A
38964	8-3/4"	14-5/8"	1"	10	CPS438-10
38969	8-3/4"	14-5/8"	2-3/8"	5	CPS438-5A

Ships assembled with 37452 bottom foam.

Inside Box Dimensions: 18-5/8" x 15" x 10"					
39119 Series	Cell Size			# of Cells	Reference #
Part #	Length	Width	Thickness	Per Box	
39040	10"	4"	1-1/4"	40	CPS460-40
39037	10"	4"	2-3/4"	20	CPS460-20A
39039	10"	5-3/8"	1-1/4"	30	CPS460-30
39035	10"	5-3/8"	2-3/4"	15	CPS460-15A
39038	10"	8-1/8"	1"	24	CPS460-24
39036	10"	8-1/8"	1-1/4"	20	CPS460-20
39033	10"	8-1/8"	2-3/4"	10	CPS460-10A
39034	10"	16-5/8"	1"	12	CPS460-12
39032	10"	16-5/8"	1-1/4"	10	CPS460-10
39041	10"	16-5/8"	2-3/4"	5	CPS460-5A

Ships assembled with 37455 bottom foam.

Inside Box Dimensions: 22-7/8" x 12-7/8" x 10"					
39109 Series	Cell Size			# of Cells	Reference #
Part #	Length	Width	Thickness	Per Box	
38982	10"	4-3/4"	1"	40	CPS440-40
38980	10"	4-3/4"	2-1/4"	20	CPS440-20A
38981	10"	6-1/2"	1"	30	CPS440-30
38978	10"	6-1/2"	2-1/4"	15	CPS440-15A
38979	10"	10"	1"	20	CPS440-20
38977	10"	10"	2-1/4"	10	CPS440-10A
38976	10"	20-1/8"	1"	10	CPS440-10
38983	10"	20-1/8"	2-1/4"	5	CPS440-5A

Ships assembled with 37453 bottom foam.

• These items made to order

See our products being
Made in America
on our web site:

ProtektivePak.com/factory





PLASTEK™ In-Plant Handlers

Lid is included for all In-Plant Handlers

Inside Box Dimensions: 17" x 13" x 10-3/4"

39108 Series		Cell Size			# of Cells	Reference #
Part #	Length	Width	Thickness	Per Box		
38974	10-3/4"	4-5/8"	1"	30		CPS439-30
38972	10-3/4"	4-5/8"	2-3/8"	15		CPS439-15A
38973	10-3/4"	7-1/8"	1"	20		CPS439-20
38971	10-3/4"	7-1/8"	2-3/8"	10		CPS439-10A
38970	10-3/4"	14-5/8"	1"	10		CPS439-10
38975	10-3/4"	14-5/8"	2-3/8"	5		CPS439-5A

Ships assembled with 37452 bottom foam.

Inside Box Dimensions: 18-5/8" x 15" x 12"

39120 Series		Cell Size			# of Cells	Reference #
Part #	Length	Width	Thickness	Per Box		
39050	12"	4"	1-1/4"	40		CPS462-40
39047	12"	4"	2-3/4"	20		CPS462-20A
39049	12"	5-3/8"	1-1/4"	30		CPS462-30
39045	12"	5-3/8"	2-3/4"	15		CPS462-15A
39048	12"	8-1/8"	1"	24		CPS462-24
39046	12"	8-1/8"	1-1/4"	20		CPS462-20
39043	12"	8-1/8"	2-3/4"	10		CPS462-10A
39044	12"	16-5/8"	1"	12		CPS462-12
39042	12"	16-5/8"	1-1/4"	10		CPS462-10
39051	12"	16-5/8"	2-3/4"	5		CPS462-5A

Ships assembled with 37455 bottom foam.

Inside Box Dimensions: 17" x 13" x 12-5/8"

39100 Series		Cell Size			# of Cells	Reference #
Part #	Length	Width	Thickness	Per Box		
38924	12-5/8"	4-5/8"	1"	30		CPS403-30
38922	12-5/8"	4-5/8"	2-3/8"	15		CPS403-15A
38923	12-5/8"	7-1/8"	1"	20		CPS403-20
38921	12-5/8"	7-1/8"	2-3/8"	10		CPS403-10A
38920	12-5/8"	14-5/8"	1"	10		CPS403-10
38925	12-5/8"	14-5/8"	2-3/8"	5		CPS403-5A

Ships assembled with 37452 bottom foam.

Inside Box Dimensions: 22-7/8" x 12-7/8" x 12-5/8"

39101 Series		Cell Size			# of Cells	Reference #
Part #	Length	Width	Thickness	Per Box		
38932	12-5/8"	4-3/4"	1"	40		CPS404-40
38930	12-5/8"	4-3/4"	2-1/4"	20		CPS404-20A
38931	12-5/8"	6-1/2"	1"	30		CPS404-30
38928	12-5/8"	6-1/2"	2-1/4"	15		CPS404-15A
38929	12-5/8"	10"	1"	20		CPS404-20
38927	12-5/8"	10"	2-1/4"	10		CPS404-10A
38926	12-5/8"	20-1/8"	1"	10		CPS404-10
38933	12-5/8"	20-1/8"	2-1/4"	5		CPS404-5A

Ships assembled with 37453 bottom foam.

Inside Box Dimensions: 18-3/8" x 12-3/8" x 12-3/4"

39113 Series		Cell Size			# of Cells	Reference #
Part #	Length	Width	Thickness	Per Box		
39010	12-3/4"	7-3/4"	1"	20		CPS452-20
39009	12-3/4"	7-3/4"	2-1/4"	10		CPS452-10A
39008	12-3/4"	16"	1"	10		CPS452-10
39011	12-3/4"	16"	2-1/4"	5		CPS452-5A

Ships assembled with 37454 bottom foam.

Inside Box Dimensions: 18-5/8" x 15" x 14"

39121 Series		Cell Size			# of Cells	Reference #
Part #	Length	Width	Thickness	Per Box		
39060	14"	4"	1-1/4"	40		CPS464-40
39057	14"	4"	2-3/4"	20		CPS464-20A
39059	14"	5-3/8"	1-1/4"	30		CPS464-30
39055	14"	5-3/8"	2-3/4"	15		CPS464-15A
39058	14"	8-1/8"	1"	24		CPS464-24
39056	14"	8-1/8"	1-1/4"	20		CPS464-20
39053	14"	8-1/8"	2-3/4"	10		CPS464-10A
39054	14"	16-5/8"	1"	12		CPS464-12
39052	14"	16-5/8"	1-1/4"	10		CPS464-10
39061	14"	16-5/8"	2-3/4"	5		CPS464-5A

Ships assembled with 37455 bottom foam.

Inside Box Dimensions: 22-7/8" x 12-7/8" x 15-1/4"

39110 Series		Cell Size			# of Cells	Reference #
Part #	Length	Width	Thickness	Per Box		
38990	15-1/4"	4-3/4"	1"	40		CPS445-40
38988	15-1/4"	4-3/4"	2-1/4"	20		CPS445-20A
38989	15-1/4"	6-1/2"	1"	30		CPS445-30
38986	15-1/4"	6-1/2"	2-1/4"	15		CPS445-15A
38987	15-1/4"	10"	1"	20		CPS445-20
38985	15-1/4"	10"	2-1/4"	10		CPS445-10A
38984	15-1/4"	20-1/8"	1"	10		CPS445-10
38991	15-1/4"	20-1/8"	2-1/4"	5		CPS445-5A

Ships assembled with 37453 bottom foam.

Inside Box Dimensions: 18-3/8" x 12-3/8" x 17-1/8"

39116 Series		Cell Size			# of Cells	Reference #
Part #	Length	Width	Thickness	Per Box		
39022	17-1/8"	7-3/4"	1"	20		CPS457-20
39021	17-1/8"	7-3/4"	2-1/4"	10		CPS457-10A
39020	17-1/8"	16"	1"	10		CPS457-10
39023	17-1/8"	16"	2-1/4"	5		CPS457-5A

Ships assembled with 37454 bottom foam.

Inside Box Dimensions: 22-7/8" x 12-7/8" x 18-1/4"

39104 Series		Cell Size			# of Cells	Reference #
Part #	Length	Width	Thickness	Per Box		
38950	18-1/4"	10"	1"	20		CPS408-20
38949	18-1/4"	10"	2-1/4"	10		CPS408-10A
38948	18-1/4"	20-1/4"	1"	10		CPS408-10
38951	18-1/4"	20-1/4"	2-1/4"	5		CPS408-5A

Ships assembled with 37453 bottom foam.

Inside Box Dimensions: 18-3/8" x 12-3/8" x 18-3/4"

39102 Series		Cell Size			# of Cells	Reference #
Part #	Length	Width	Thickness	Per Box		
38936	18-3/4"	8"	1"	20		CPS405-20
38935	18-3/4"	8"	2-1/4"	10		CPS405-10A
38934	18-3/4"	16-1/4"	1"	10		CPS405-10
38937	18-3/4"	16-1/4"	2-1/4"	5		CPS405-5A

Ships assembled with 37454 bottom foam.



See our products being
Made in America
on our web site:
ProtektivePak.com/factory

• These items made to order



PLASTEK™ Storage Containers

Lid sold separately

FEATURES

- Meets ANSI/ESD S20.20 and Packaging Standard ANSI/ESD S541
- Provides physical protection with conductive material providing reliable path-to-ground
- Includes steel wire frame for extra strength
- Conductive plastic handle for ease of handling while providing reliable path-to-ground
- Product ships assembled
- Available options include: (1) Lid manufactured from Plastek™; (2) Static Dissipative Foam bottom to provide ESD and shock protection
- All Plastek features listed on [page 20](#)
- Rs: 1×10^2 to $< 1 \times 10^5$ ohms
- Made in the United States of America

Download Drawing [39106](#)

Part #	Description	Size*
39130	Lid	17-7/8" x 13-5/8" x 2"
39132	Lid	19-3/8" x 13-3/8" x 2"
39133	Lid	19-3/8" x 15-3/4" x 2"
39131	Lid	23-1/2" x 13-3/8" x 2"

Lids sold separately

Part #	REF #	Box Size - L x W x D*	Lid
39106	CPS436-BX	17" x 13" x 6-3/4"	39130
39107	CPS438-BX	17" x 13" x 8-3/4"	39130
39175		17" x 13" x 8-3/4", Stacking	39130
39108	CPS439-BX	17" x 13" x 10-3/4"	39130
39100	CPS403-BX	17" x 13" x 12-5/8"	39130
39105	CPS434-BX	17" x 13" x 14-3/4"	39130
39113	CPS452-BX	18-3/8" x 12-3/8" x 12-3/4"	39132
39116	CPS457-BX	18-3/8" x 12-3/8" x 17-1/8"	39132
39102	CPS405-BX	18-3/8" x 12-3/8" x 18-3/4"	39132
39103	CPS406-BX	18-5/8" x 15" x 5-7/8"	39133
39122	CPS468-BX	18-5/8" x 15" x 8"	39133

Part #	REF #	Box Size - L x W x D*	Lid
39119	CPS460-BX	18-5/8" x 15" x 10"	39133
39120	CPS462-BX	18-5/8" x 15" x 12"	39133
39121	CPS464-BX	18-5/8" x 15" x 14"	39133
39111	CPS446-BX	22-7/8" x 12-7/8" x 6"	39131
39112	CPS448-BX	22-7/8" x 12-7/8" x 8"	39131
39109	CPS440-BX	22-7/8" x 12-7/8" x 10"	39131
39101	CPS404-BX	22-7/8" x 12-7/8" x 12-5/8"	39131
39110	CPS445-BX	22-7/8" x 12-7/8" x 15-1/4"	39131
39104	CPS408-BX	22-7/8" x 12-7/8" x 18-1/4"	39131

- * Inside Dimensions
- These items made to order



PLASTEK™ Tek Trays

FEATURES

- Meets ANSI/ESD S20.20 and Packaging Standard ANSI/ESD S541
- Convenient storage tray made of conductive material, providing reliable path-to-ground
- Includes steel wire frame which allows trays to stack, improving productivity and saving valuable space
- Static dissipative foam bottom provides ESD and shock protection
- Yellow stacking wire is easy to see and helps provide visual identification
- Static Dissipative Foam bottom laminated to Plastek™
- Conductive 1×10^2 to $< 1 \times 10^5$ ohms material provides reliable path-to-ground
- Ideal for use where corrugated and/or paper products cannot be used
- Great container for Kanban
- All Plastek features listed on [page 20](#)
- Made in the United States of America

Download Drawing [39160](#)

Part #	Size I.D. - L x W x D
39160	18" x 11-3/8" x 1-3/4"
39161	22-3/4" x 17-1/2" x 2-1/2"

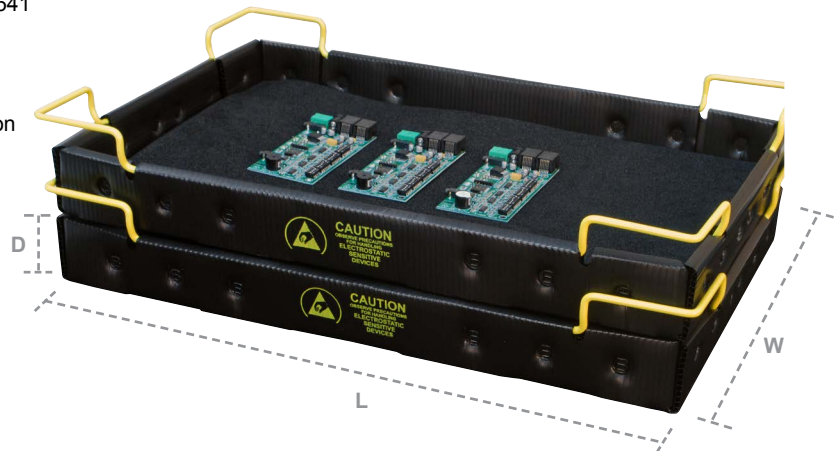



PLASTEK™ Open Bin Boxes

FEATURES

- Meets ANSI/ESD S20.20 and Packaging Standard ANSI/ESD S541
- Provides physical protection, with conductive material providing reliable path-to-ground
- Many sizes available
- Shipped knocked-down; easy to assemble
- All Plastek features listed on [page 20](#)
- Rs: 1×10^2 to $< 1 \times 10^5$ ohms
- Made in the United States of America

Download Drawing [38900](#)

Part #	Size O.D. - L x W x D
38900	12" x 2" x 4"
38901	12" x 4" x 4"
38902	12" x 6" x 4"
38903	12" x 8" x 4"
38909	18" x 2" x 4"
38904	18" x 4" x 4"

Part #	Size O.D. - L x W x D
38905	18" x 6" x 4"
38906	18" x 8" x 4"
38910	24" x 2" x 4"
38907	24" x 4" x 4"
38908	24" x 6" x 4"

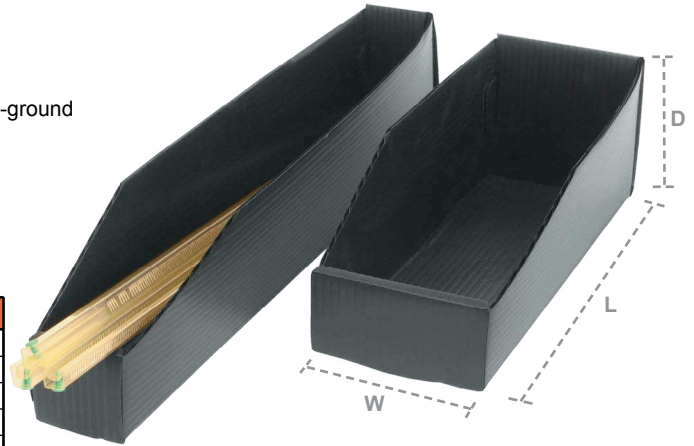

Conductive Fluted Plastek™ Sheets

FEATURES

- Great for use as a divider or lining shelves
- Made from extruded high impact polypropylene materials
- Conductive Rtt 1×10^2 to $< 1 \times 10^5$ ohms
- Meets ANSI/ESD S20.20 worksurface required limit per ANSI/ESD S4.1 and ESD TR53
- Chemical and moisture resistant
- Thickness of both 3mm and 4mm available
- Durable, reusable, will not lose shielding and static charge decay properties
- All Plastek features listed on [page 20](#)
- Made in the United States of America

Download Drawing [39350](#)

Part #	Size - L x W x D
39350	3MM x 24" x 36"
39351	3MM x 24" x 48"
39352	3MM x 48" x 48"
39353	3MM x 60" x 48"
39355	3MM x 96" x 48"
39356	4MM x 24" x 36"
39357	4MM x 36" x 48"
39358	4MM x 48" x 48"
39359	4MM x 60" x 48"
39361	4MM x 96" x 48"

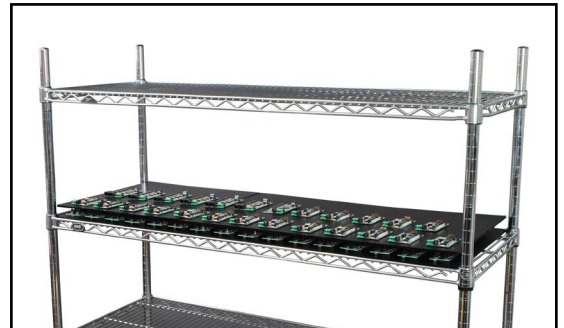



ESD Plastek™ Turntable



FEATURES

- Ideal for use where corrugated and/or paper products cannot be used
- Durable ¼" thick dissipative, crosslink polyethylene foam laminated to conductive fluted Plastek
- Galvanized Steel Turntable located at the bottom
- Size: Choice of 12-1/2" or 15-1/2" circle
- Very low profile - 1" high
- Weight capacity 50 lbs / 23 Kg, ideal for working on heavier assemblies
- Volume Resistance 1×10^6 to $< 1 \times 10^9$ ohms per ANSI/STM11.12
- Meets worksurface required limit of ANSI/ESD S20.20 per ANSI/ESD S4.1 and ESD TR53
- Electrostatic charges removed to ground via contact on grounded ESD worksurface or via optional [47204](#) ground cord
- All Plastek features listed on [page 20](#)
- Made in the United States of America

Download Drawing [47202](#)



Part #	Description
47202	ESD Dissipative Turntable, 12.5"
47203	ESD Dissipative Turntable, 15.5"
47204	Ground Cord

Plastek™ Vertical Reel Holders



FEATURES

- Space saving, economical method of storing reels
- Includes steel wire frame for extra strength
- Sizes available to fit 7" and 13" reels
- Available with corners allowing the reel holders to be stacked securely without slipping [47205](#) and [47206](#)
- Made from extruded, high impact polypropylene material
- Product ships assembled
- Chemical and moisture resistant
- Visual slot for viewing reel inventory
- Includes thumb notch for easy access and removal of reel
- All Plastek features listed on [page 20](#)
- Made in the United States of America

Download Drawing [37568](#)

Part #	Description
37568	Vertical Reel Holder, 7"
37569	Vertical Reel Holder, 13"
47205	Stacking Vertical Reel Holder, 7"
47206	Stacking Vertical Reel Holder, 13"

