



Chipsmall Limited consists of a professional team with an average of over 10 year of expertise in the distribution of electronic components. Based in Hongkong, we have already established firm and mutual-benefit business relationships with customers from,Europe,America and south Asia,supplying obsolete and hard-to-find components to meet their specific needs.

With the principle of “Quality Parts,Customers Priority,Honest Operation,and Considerate Service”,our business mainly focus on the distribution of electronic components. Line cards we deal with include Microchip,ALPS,ROHM,Xilinx,Pulse,ON,Everlight and Freescale. Main products comprise IC,Modules,Potentiometer,IC Socket,Relay,Connector.Our parts cover such applications as commercial,industrial, and automotives areas.

We are looking forward to setting up business relationship with you and hope to provide you with the best service and solution. Let us make a better world for our industry!



Contact us

Tel: +86-755-8981 8866 Fax: +86-755-8427 6832

Email & Skype: info@chipsmall.com Web: www.chipsmall.com

Address: A1208, Overseas Decoration Building, #122 Zhenhua RD., Futian, Shenzhen, China



*RoHS COMPLIANT



BOURNS®

Features

- Conductive plastic technology
- Low profile package
- 50,000 cycle rotational life
- Available with momentary push or rotary switch option
- PCB mount terminal configuration
- Rugged metal housing for industrial applications
- Flatted or slotted shaft options
- RoHS compliant*

39 – 13 mm Single-Turn Panel Control with Switch Option

Electrical Characteristics

Standard Resistance Range	5 K - 100 K ohms
Total Resistance Tolerance	±20 %
Independent Linearity	±5 %
End Resistance	2 ohms maximum
Effective Electrical Angle	
Non-Switch Type (Bushing Type "S")	220° ± 5°
Rotary Switch Type (Bushing Type "S")	220° ± 5°
Momentary Push Switch Type (Bushing Type "L")	201° ± 5°
Contact Resistance Variation	3 % maximum
Dielectric Withstanding Voltage (MIL-STD-202, Method 301)	
Sea Level	750 VRMS minimum
Insulation Resistance	100 megohms minimum
Power Rating @ 70 °C (Derated to 0 @ 125 °C)	
(Voltage Limited by Power Dissipation or 350 VAC, whichever is less)	
Linear Taper	0.25 watt
Audio Taper	0.125 watt

Switch Characteristics

Rotary Switch Type	SPST N.O.
Power Rating (Resistive Load)	1.5 amps @ 12 VDC
Contact Resistance @ 10 mA	200 milliohms maximum
Contact Bounce	5 milliseconds
Actuation Torque	0.7 to 4.9 N-cm (1 to 7 oz.-in.)
Momentary Push Switch Type	SPST N.O.
Power Rating (Resistive Load)	250 milliamps @ 12 VDC
Contact Resistance @ 10 mA (w/500 gm Shaft Load)	50 ohms maximum
Contact Bounce	5 milliseconds
Actuation Force	500 ± 100 gram

Environmental Characteristics

Operating Temperature Range	-40 °C to +85 °C (-40 °F to +185 °F)
Storage Temperature Range	-55 °C to +85 °C (-67 °F to +185 °F)
Vibration	15 G
Total Resistance Shift	±3 %
Voltage Ratio Shift	±5 %
Shock	30 G
Total Resistance Shift	±3 %
Voltage Ratio Shift	±5 %
Load Life	1,000 Hours
Total Resistance Shift	±10 %
Rotational Life (No Load)	50,000 cycles
Total Resistance Shift	±10 %
Switch Life	
Rotary Switch Type	25,000 cycles
Momentary Push Switch Type	50,000 cycles
Moisture Resistance	MIL-STD-202, Method 103, Condition B
Total Resistance Shift	±10 %
IP Rating	IP 40

Mechanical Characteristics

Stop Strength	19.8 N-cm (28 oz.-in.)
Mechanical Angle	
Non-Switch and Rotary Switch Type	270° ± 10°
Momentary Push Switch Type	230° ± 10°
Torque	
Starting	0.07 to 0.70 N-cm (0.1 to 1.0 oz.-in.) minimum
Running	0.07 to 0.53 N-cm (0.1 to 0.75 oz.-in.) maximum
Mounting	1.7 to 2.0 N-m (15 to 18 lbs.-in.) maximum
Shaft Retention	
Pull Force	4 Kg (8.8 lb.) maximum
Push Force	4.5 Kg (10 lb.) maximum
Weight (Single Section)	4 grams (0.14 oz.)
Terminals	
Potentiometer	Printed circuit board terminals
Switch	Flat terminals
Soldering Condition	
Manual Soldering	96.5Sn/3.0Ag/0.5Cu solid wire or no-clean rosin cored wire; 370 °C (700 °F) max. for 3 seconds
Wave Soldering	96.5Sn/3.0Ag/0.5Cu solder with no-clean flux; 260 °C (500 °F) max. for 5 seconds
Wash processes	Not recommended
Marking	Manufacturer's trademark, part number and date code
Ganging	1 cup maximum
Hardware	One lockwasher and one mounting nut is shipped with each potentiometer, except where noted in the part number
Packaging	100 pcs./tray

*RoHS Directive 2002/95/EC Jan. 27, 2003 including annex and RoHS Recast 2011/65/EU June 8, 2011. Specifications are subject to change without notice.

The device characteristics and parameters in this data sheet can and do vary in different applications and actual device performance may vary over time. Users should verify actual device performance in their specific applications.

39 – 13 mm Single-Turn Panel Control with Switch Option

BOURNS®

Product Dimensions

BUSHING STYLE "L"

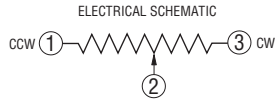
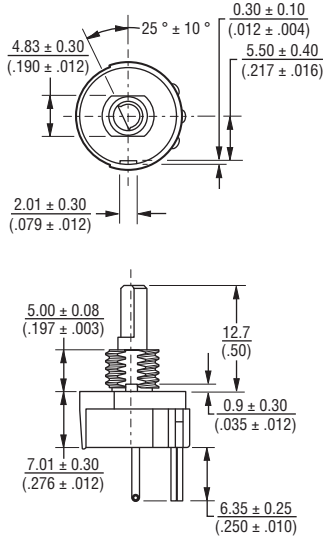

BOTTOM VIEW

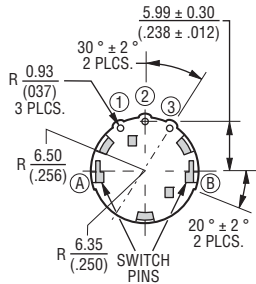

BUSHING STYLE "S"

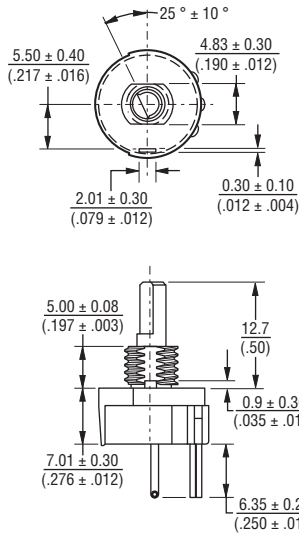

BOARD LAYOUT

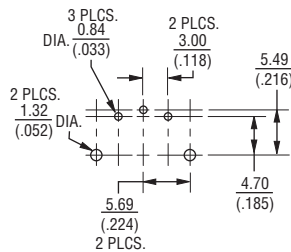

SHAFT STYLE "A"

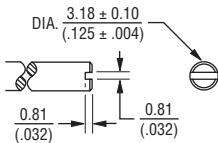

SHAFT STYLE "B"

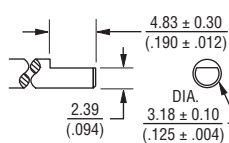

How To Order

39 S B - 1 R B - 503

SWITCH TYPE

Code	Description
N	No Switch
P	Momentary Push
R	Rotary Switch

TERMINAL CONFIGURATION

Code	Description
1	6.35 mm (.250")

SHAFT TYPE (SEE SHAFT STYLE FIGURES)

Code	Description
A	Slotted Shaft, Dia. 3.175 mm (1/8") x 12.7 mm (1/2") FMS
B	Flatted Shaft, Dia. 3.175 mm (1/8") x 12.7 mm (1/2") FMS

BUSHING TYPE (SEE BUSHING STYLE FIGURES)

Code	Description	EFFECTIVE ELECTRICAL ANGLE	AVAILABLE ONLY IN SWITCH TYPE
L	1/4-28-UNF-2A x 5 mm (.197") FMS	201	P
S	1/4-28-UNF-2A x 5 mm (.197") FMS	220	R & N

MODEL NUMBER

Code	Description
39	Model 39

ELEMENT TAPER

Code	Description
B	Linear C.P. 20 %
D	CW Audio C.P. 20 %
G	CCW Audio C.P. 20 %

RESISTANCE CODE 20 %

Code	Description
502	5 K Ohms (13)
103	10 K Ohms (15)
203	20 K Ohms (16)
253	25 K Ohms (17)
503	50 K Ohms (18)
104	100 K Ohms (20)

DIMENSIONS: $\frac{\text{MM}}{\text{(INCHES)}}$

TOLERANCES EXCEPT AS SHOWN:
 .XX $\frac{0.13}{(.005)}$.X $\frac{0.38}{(.015)}$

REV. 03/13

Specifications are subject to change without notice.

The device characteristics and parameters in this data sheet can and do vary in different applications and actual device performance may vary over time. Users should verify actual device performance in their specific applications.