



Chipsmall Limited consists of a professional team with an average of over 10 year of expertise in the distribution of electronic components. Based in Hongkong, we have already established firm and mutual-benefit business relationships with customers from,Europe,America and south Asia,supplying obsolete and hard-to-find components to meet their specific needs.

With the principle of "Quality Parts,Customers Priority,Honest Operation,and Considerate Service",our business mainly focus on the distribution of electronic components. Line cards we deal with include Microchip,ALPS,ROHM,Xilinx,Pulse,ON,Everlight and Freescale. Main products comprise IC,Modules,Potentiometer,IC Socket,Relay,Connector.Our parts cover such applications as commercial,industrial, and automotives areas.

We are looking forward to setting up business relationship with you and hope to provide you with the best service and solution. Let us make a better world for our industry!



Contact us

Tel: +86-755-8981 8866 Fax: +86-755-8427 6832

Email & Skype: info@chipsmall.com Web: www.chipsmall.com

Address: A1208, Overseas Decoration Building, #122 Zhenhua RD., Futian, Shenzhen, China



UM (V-EA) Series

UL508 Listed Manual Motor Controllers “Suitable as Motor Disconnect”

- DIN Rail Mounted
- 17.5mm width per pole
- Thermal Magnetic
- 0.3-60A / 480Y/277V AC, 50/60Hz
- 10kA Short Circuit Withstand Capacity
- Applications Include:
 - AC Motor Starting, Across the Line
 - AC General Use
 - AC Resistance
 - AC Discharge Lamps (Ballast)
 - AC Incandescent Lamps (Tungsten)



UL508 Listed
E137938



up to 25A
B,C,D curve



up to 25A
B,C,D curve



Current/ Voltage Rating	0.3-60A/480Y/277V AC 0.3-25A: 1 pole - 42V DC; 2 Pole - 80V DC 30-60A: 1 pole - 24V DC; 2 Pole - 60V DC
Short Circuit Withstand Rating (UL/CSA - Ratings)	0.3-60A (RC): 10kA with UL-listed RK5 back-up fuse or MCCB
Group Short Circuit Withstand Rating (UL/CSA - Ratings)	0.3-10A (RC): 10kA; 12-60A (RC): 5kA no branch circuit protection required
Interrupting Capacity (VDE - Ratings)	0.3-63A (RC): 10kA
Calibration Temperature	40°C (104°F)
Operating Temperature	-25°C to 55°C (-13°F to 131°F)
Storage Temperature	-40°C to 70°C (-40°F to 158°F)
Terminal Size Acceptability	Top: 18-3 AWG; Bottom: 18-2 AWG
Terminal Torque (min/max)	2 Nm (17.7 lb.in.) / 2.5Nm (22.2 lb.in)
Horse Power Ratings	see page 46
Mechanical Endurance Ratings	see page 47
Vibration Resistance	> 15g according to DIN EN 60069-2-59 during a load with $I_1 = 1.05 \times I_N$
Degree of protection acc. IEC/EN 60529	IP20
Mounting Orientation	In any plane

Short Circuit Withstand Ratings for UM (V-EA) Manual Motor Controller

Trip Curve	Amp Range	Backup Protection	UL-Listed RK5-Fuse up to 10kA	UL-Listed MCCB up to 10kA	No BCP Required up to:
all	0.3 - 10A		4xRC* min 15A, max 70A	4xRC* min 15A, max 70A	10kA
all	12 - 30/32A		4xRC* max 125A	4xRC* max 125A	5kA
all	40 - 50A		4xRC* max 200A	4xRC* max 200A	5kA
all	60 / 63A		4xRC* max 250A	4xRC* max 250A	5kA

*up to nearest rated current

Marking Details

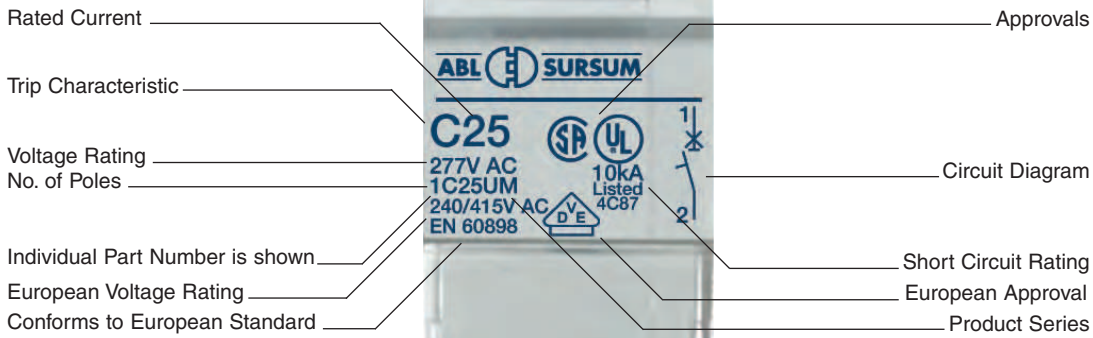

Dimensions in mm

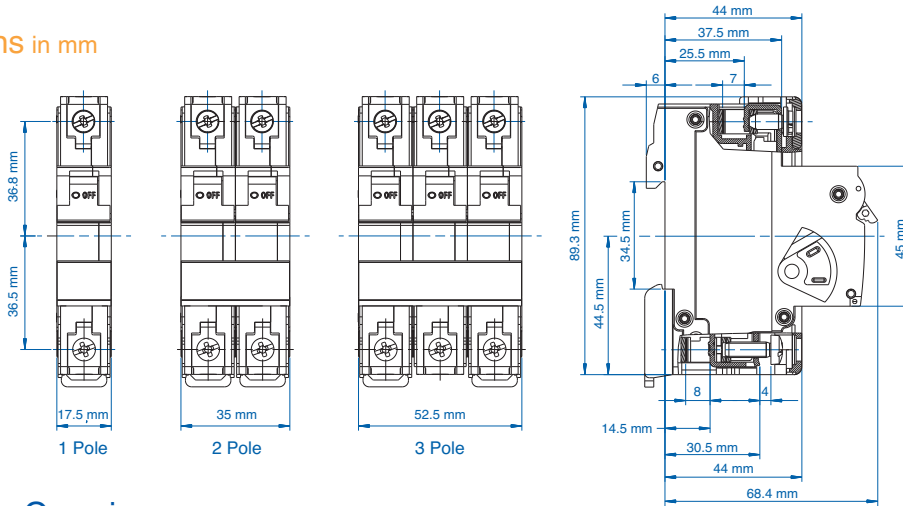

Application Overview

Trip-Characteristics*				Applications											
Characteristic Trip Boundaries				Lighting Wiring Protection Control Circuits	Business Equipment Appliances	Transformers	Power Supplies Heaters	Motors				General Electronics	Solenoid	Semi- conductors Components/ devices with low surge- current and short circuit withstand capabilities	Reactive Load
Thermal Trip		Magnetic Trip						General	Low Inrush	High Inrush	High Efficiency				
Must not Trip >100ms	Must Trip <1hr	Must not Trip >100ms	Must Trip at 100ms												
B-Characteristics				■	■					■					
1.13xRC	1.45xRC	3xRC	5xRC						■						
C-Characteristics				■	■				■						
1.13xRC	1.45xRC	5xRC	10xRC												
D-Characteristics						■	■		■					■	
1.13xRC	1.45xRC	10xRC	16xRC												
E-Characteristics						■	■			■					
1.05xRC	1.35xRC	14xRC	18xRC												
G-Characteristics				■		■			■			■			
1.05xRC	1.35xRC	8xRC	10xRC					■	■						
Z-Characteristics											■		■		
1.05xRC	1.35xRC	2xRC	3xRC												

*The value of each characteristic is shown vertically beneath its corresponding heading.



Warning!

This information should only be used as a selection guide. The use of a Miniature Circuit Breaker/Manual Motor Controller in an application with a certain Trip-Characteristic always requires prototype testing! It is the responsibility of the circuit design engineer to select the appropriate Miniature Circuit Breaker/Manual Motor Controller for his specific application.

UL 489

UL 508

UL 1077

UL 1077
Equipment Breakers

Earth Leakage
Circuit Breakers

ANNEX

V-EA Series B-Trip Characteristic

Application Examples:

Business equipment, wiring protection, lighting, appliances, control circuits, some motors and some electronic applications. Relatively long thermal trip delay but low magnetic trip point.



Standard Pack: 12

Weight:

0.3A - 32A

1.75kg (3.86 lb.)

40A - 63A

2.07kg (4.56 lb.)

One Pole

Rated Current	Type/ Voltage	Approvals
1.0A	1B1UM	UL SF
1.6A	1B1.6UM	UL SF
2.0A	1B2UM	UL SF
2.5A	1B2.5UM	UL SF
3.0A	1B3UM	UL SF
3.5A	1B3.5UM	UL SF
4.0A	1B4UM	UL SF
5.0A	1B5UM	UL SF
6.0A	1B6UM	UL SF
10A	1B10UM	UL SF
13A	1B13UM	UL SF
15A	1B15UM	UL SF
16A	1B16UM	UL SF
20A	1B20UM	UL SF
25A	1B25UZ	UL SF
30A	1B30UM	UL SF
32A	1B32UM	UL SF
40A	1B40UM	UL SF
50A	1B50UM	UL SF
60A	1B60UM	UL SF
63A	1B63UM	UL SF



Standard Pack: 4

Weight:

0.3A - 32A

1.75kg (3.86 lb.)

40A - 63A

2.07kg (4.56 lb.)

Three Pole

Rated Current	Type/ Cat. No.	Approvals
1.0A	3B1UM	UL SF
1.6A	3B1.6UM	UL SF
2.0A	3B2UM	UL SF
2.5A	3B2.5UM	UL SF
3.0A	3B3UM	UL SF
3.5A	3B3.5UM	UL SF
4.0A	3B4UM	UL SF
5.0A	3B5UM	UL SF
6.0A	3B6UM	UL SF
10A	3B10UM	UL SF
13A	3B13UM	UL SF
15A	3B15UM	UL SF
16A	3B16UM	UL SF
20A	3B20UM	UL SF
25A	3B25UM	UL SF
30A	3B30UM	UL SF
32A	3B32UM	UL SF
40A	3B40UM	UL SF
50A	3B50UM	UL SF
60A	3B60UM	UL SF
63A	3B63UM	UL SF



Standard Pack: 6

Weight:

0.3A - 32A

1.75kg (3.86 lb.)

40A - 63A

2.07kg (4.56 lb.)

Two Pole

Rated Current	Type/ Cat. No.	Approvals
1.0A	2B1UM	UL SF
1.6A	2B1.6UM	UL SF
2.0A	2B2UM	UL SF
2.5A	2B2.5UM	UL SF
3.0A	2B3UM	UL SF
3.5A	2B3.5UM	UL SF
4.0A	2B4UM	UL SF
5.0A	2B5UM	UL SF
6.0A	2B6UM	UL SF
10A	2B10UM	UL SF
13A	2B13UM	UL SF
15A	2B15UM	UL SF
16A	2B16UM	UL SF
20A	2B20UM	UL SF
25A	2B25UM	UL SF
30A	2B30UM	UL SF
32A	2B32UM	UL SF
40A	2B40UM	UL SF
50A	2B50UM	UL SF
60A	2B60UM	UL SF
63A	2B63UM	UL SF



Add-on Neutral Pole

Rated Current	Type/ Cat. No.	Approvals
0.3-63A/ 480Y/277V	N63UM	UL SF

Standard Pack: 6

Weight:

0.775kg (1.71lb.)

Standard Dual Connection Terminal

- Box clamp terminals
Top: 18-3 AWG;
Bottom: 18-2 AWG
(Line/Load reversible)
- Ring tongue terminals

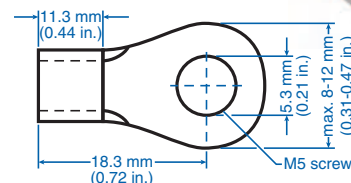

* May differ by manufacturer. Top terminal ring tongue max. thickness 1.6mm.

V-EA Series C-Trip Characteristic

Application Examples:

Low inrush motors, lighting, wiring protection, appliances, business equipment, and control circuit applications. Relatively long thermal trip delay and medium magnetic trip point.



Standard Pack: 12

Weight:

0.3A - 32A
1.75kg (3.86 lb.)
40A - 63A
2.07kg (4.56 lb.)

One Pole

Rated Current	Type/ Cat. No.	Approvals
0.3A	1C03UM	UL SP
0.5A	1C05UM	UL SP
0.75A	1C075UM	UL SP
1.0A	1C1UM	UL SP
1.6A	1C1.6UM	UL SP
2.0A	1C2UM	UL SP
2.5A	1C2.5UM	UL SP
3.0A	1C3UM	UL SP
3.5A	1C3.5UM	UL SP
4.0A	1C4UM	UL SP
5.0A	1C5UM	UL SP
6.0A	1C6UM	UL SP
8.0A	1C8UM	UL SP
10A	1C10UM	UL SP
13A	1C13UM	UL SP
15A	1C15UM	UL SP
16A	1C16UM	UL SP
20A	1C20UM	UL SP
25A	1C25UM	UL SP
30A	1C30UM	UL SP
32A	1C32UM	UL SP
40A	1C40UM	UL SP
50A	1C50UM	UL SP
60A	1C60UM	UL SP
63A	1C63UM	UL SP



Standard Pack: 4

Weight:

0.3A - 32A
1.75kg (3.86 lb.)
40A - 63A
2.07kg (4.56 lb.)

Three Pole

Rated Current	Type/ Cat. No.	Approvals
0.3A	3C03UM	UL SP
0.5A	3C05UM	UL SP
0.75A	3C075UM	UL SP
1.0A	3C1UM	UL SP
1.6A	3C1.6UM	UL SP
2.0A	3C2UM	UL SP
2.5A	3C2.5UM	UL SP
3.0A	3C3UM	UL SP
3.5A	3C3.5UM	UL SP
4.0A	3C4UM	UL SP
5.0A	3C5UM	UL SP
6.0A	3C6UM	UL SP
8.0A	3C8UM	UL SP
10A	3C10UM	UL SP
13A	3C13UM	UL SP
15A	3C15UM	UL SP
16A	3C16UM	UL SP
20A	3C20UM	UL SP
25A	3C25UM	UL SP
30A	3C30UM	UL SP
32A	3C32UM	UL SP
40A	3C40UM	UL SP
50A	3C50UM	UL SP
60A	3C60UM	UL SP
63A	3C63UM	UL SP



Standard Pack: 6

Weight:

0.3A - 32A
1.75kg (3.86 lb.)
40A - 63A
2.07kg (4.56 lb.)

Two Pole

Rated Current	Type/ Cat. No.	Approvals
0.3A	2C03UM	UL SP
0.5A	2C05UM	UL SP
0.75A	2C075UM	UL SP
1.0A	2C1UM	UL SP
1.6A	2C1.6UM	UL SP
2.0A	2C2UM	UL SP
2.5A	2C2.5UM	UL SP
3.0A	2C3UM	UL SP
3.5A	2C3.5UM	UL SP
4.0A	2C4UM	UL SP
5.0A	2C5UM	UL SP
6.0A	2C6UM	UL SP
8.0A	2C8UM	UL SP
10A	2C10UM	UL SP
13A	2C13UM	UL SP
15A	2C15UM	UL SP
16A	2C16UM	UL SP
20A	2C20UM	UL SP
25A	2C25UM	UL SP
30A	2C30UM	UL SP
32A	2C32UM	UL SP
40A	2C40UM	UL SP
50A	2C50UM	UL SP
60A	2C60UM	UL SP
63A	2C63UM	UL SP



Add-on Neutral Pole

Rated Current	Type/ Cat. No.	Approvals
0.3-63A/ 480Y/277V	N63UM	UL SP

Standard Pack: 6

Weight:

0.775kg (1.71lb.)

Standard Dual Connection Terminal

- Box clamp terminals
Top: 18-3 AWG;
Bottom: 18-2 AWG
(Line/Load reversible)
- Ring tongue terminals

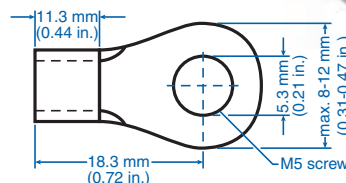
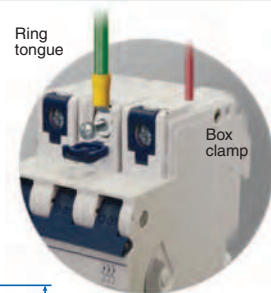

* May differ by manufacturer. Top terminal ring tongue max. thickness 1.6mm.

UL 489

UL 508

UL 1077

UL 1077
Equipment Breakers

Earth Leakage
Circuit Breakers

ANNEX

V-EA Series D-Trip Characteristic

Application Examples:

High inrush motors, transformers, power supplies, heaters and reactive loads. Relatively long thermal trip delay and very high magnetic trip point.



UL508 Listed
E137938



upto 25A
B,C,D curve



One Pole



Standard Pack: 12

Weight:

0.3A - 32A

1.75kg (3.86 lb.)

40A - 63A

2.07kg (4.56 lb.)

Rated Current	Type/ Cat. No.	Approvals
0.3A	1D03UM	UL SF
0.5A	1D05UM	UL SF
0.75A	1D075UM	UL SF
1.0A	1D1UM	UL SF
1.6A	1D1.6UM	UL SF
2.0A	1D2UM	UL SF
2.5A	1D2.5UM	UL SF
3.0A	1D3UM	UL SF
3.5A	1D3.5UM	UL SF
4.0A	1D4UM	UL SF
5.0A	1D5UM	UL SF
6.0A	1D6UM	UL SF
8.0A	1D8UM	UL SF
10A	1D10UM	UL SF
13A	1D13UM	UL SF
15A	1D15UM	UL SF
16A	1D16UM	UL SF
20A	1D20UM	UL SF
25A	1D25UM	UL SF
30A	1D30UM	UL SF
32A	1D32UM	UL SF
40A	1D40UM	UL SF
50A	1D50UM	UL SF
60A	1D60UM	UL SF
63A	1D63UM	UL SF

Three Pole



Standard Pack: 4

Weight:

0.3A - 32A

1.75kg (3.86 lb.)

40A - 63A

2.07kg (4.56 lb.)

Rated Current	Type/ Cat. No.	Approvals
0.3A	3D03UM	UL SF
0.5A	3D05UM	UL SF
0.75A	3D075UM	UL SF
1.0A	3D1UM	UL SF
1.6A	3D1.6UM	UL SF
2.0A	3D2UM	UL SF
2.5A	3D2.5UM	UL SF
3.0A	3D3UM	UL SF
3.5A	3D3.5UM	UL SF
4.0A	3D4UM	UL SF
5.0A	3D5UM	UL SF
6.0A	3D6UM	UL SF
8.0A	3D8UM	UL SF
10A	3D10UM	UL SF
13A	3D13UM	UL SF
15A	3D15UM	UL SF
16A	3D16UM	UL SF
20A	3D20UM	UL SF
25A	3D25UM	UL SF
30A	3D30UM	UL SF
32A	3D32UM	UL SF
40A	3D40UM	UL SF
50A	3D50UM	UL SF
60A	3D60UM	UL SF
63A	3D63UM	UL SF

Two Pole



Standard Pack: 6

Weight:

0.3A - 32A

1.75kg (3.86 lb.)

40A - 63A

2.07kg (4.56 lb.)

Rated Current	Type/ Cat. No.	Approvals
0.3A	2D03UM	UL SF
0.5A	2D05UM	UL SF
0.75A	2D075UM	UL SF
1.0A	2D1UM	UL SF
1.6A	2D1.6UM	UL SF
2.0A	2D2UM	UL SF
2.5A	2D2.5UM	UL SF
3.0A	2D3UM	UL SF
3.5A	2D3.5UM	UL SF
4.0A	2D4UM	UL SF
5.0A	2D5UM	UL SF
6.0A	2D6UM	UL SF
8.0A	2D8UM	UL SF
10A	2D10UM	UL SF
13A	2D13UM	UL SF
15A	2D15UM	UL SF
16A	2D16UM	UL SF
20A	2D20UM	UL SF
25A	2D25UM	UL SF
30A	2D30UM	UL SF
32A	2D32UM	UL SF
40A	2D40UM	UL SF
50A	2D50UM	UL SF
60A	2D60UM	UL SF
63A	2D63UM	UL SF

Add-on Neutral Pole



Rated Current	Type/ Cat. No.	Approvals
0.3-63A/ 480Y/277V	N63UM	UL SF

Standard Pack: 6

Weight:

0.775kg (1.71lb.)

Standard Dual Connection Terminal

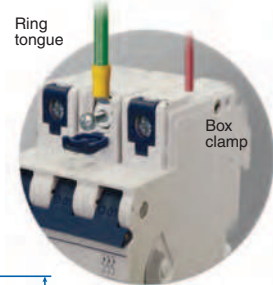

- Box clamp terminals
Top: 18-3 AWG;
Bottom: 18-2 AWG
(Line/Load reversible)
- Ring tongue terminals

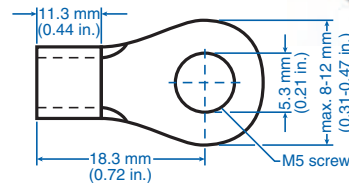

* May differ by manufacturer. Top terminal ring tongue max. thickness 1.6mm.

V-EA Series E-Trip Characteristic

Application Examples:

High efficiency motors, which have exceedingly high inrush currents. Relatively short thermal trip delays and very high magnetic trip points.



Standard Pack: 12

Weight:

0.3A - 32A
1.75kg (3.86 lb.)
40A - 63A
2.07kg (4.56 lb.)

One Pole

Rated Current	Type/ Cat. No.	Approvals
0.3A	1E03UM	UL SF
0.5A	1E05UM	UL SF
0.75A	1E075UM	UL SF
1.0A	1E1UM	UL SF
1.6A	1E1.6UM	UL SF
2.0A	1E2UM	UL SF
2.5A	1E2.5UM	UL SF
3.0A	1E3UM	UL SF
3.5A	1E3.5UM	UL SF
4.0A	1E4UM	UL SF
5.0A	1E5UM	UL SF
6.0A	1E6UM	UL SF
8.0A	1E8UM	UL SF
10A	1E10UM	UL SF
12A	1E12UM	UL SF
13A	1E13UM	UL SF
15A	1E15UM	UL SF
16A	1E16UM	UL SF
20A	1E20UM	UL SF
25A	1E25UM	UL SF
30A	1E30UM	UL SF
32A	1E32UM	UL SF
40A	1E40UM	UL SF
50A	1E50UM	UL SF
60A	1E60UM	UL SF
63A	1E63UM	UL SF



Standard Pack: 4

Weight:

0.3A - 32A
1.75kg (3.86 lb.)
40A - 63A
2.07kg (4.56 lb.)

Three Pole

Rated Current	Type/ Cat. No.	Approvals
0.3A	3E03UM	UL SF
0.5A	3E05UM	UL SF
0.75A	3E075UM	UL SF
1.0A	3E1UM	UL SF
1.6A	3E1.6UM	UL SF
2.0A	3E2UM	UL SF
2.5A	3E2.5UM	UL SF
3.0A	3E3UM	UL SF
3.5A	3E3.5UM	UL SF
4.0A	3E4UM	UL SF
5.0A	3E5UM	UL SF
6.0A	3E6UM	UL SF
8.0A	3E8UM	UL SF
10A	3E10UM	UL SF
12A	3E12UM	UL SF
13A	3E13UM	UL SF
15A	3E15UM	UL SF
16A	3E16UM	UL SF
20A	3E20UM	UL SF
25A	3E25UM	UL SF
30A	3E30UM	UL SF
32A	3E32UM	UL SF
40A	3E40UM	UL SF
50A	3E50UM	UL SF
60A	3E60UM	UL SF
63A	3E63UM	UL SF



Standard Pack: 6

Weight:

0.3A - 32A
1.75kg (3.86 lb.)
40A - 63A
2.07kg (4.56 lb.)

Two Pole

Rated Current	Type/ Cat. No.	Approvals
0.3A	2E03UM	UL SF
0.5A	2E05UM	UL SF
0.75A	2E075UM	UL SF
1.0A	2E1UM	UL SF
1.6A	2E1.6UM	UL SF
2.0A	2E2UM	UL SF
2.5A	2E2.5UM	UL SF
3.0A	2E3UM	UL SF
3.5A	2E3.5UM	UL SF
4.0A	2E4UM	UL SF
5.0A	2E5UM	UL SF
6.0A	2E6UM	UL SF
8.0A	2E8UM	UL SF
10A	2E10UM	UL SF
12A	2E12UM	UL SF
13A	2E13UM	UL SF
15A	2E15UM	UL SF
16A	2E16UM	UL SF
20A	2E20UM	UL SF
25A	2E25UM	UL SF
30A	2E30UM	UL SF
32A	2E32UM	UL SF
40A	2E40UM	UL SF
50A	2E50UM	UL SF
60A	2E60UM	UL SF
63A	2E63UM	UL SF



Add-on Neutral Pole

Rated Current	Type/ Cat. No.	Approvals
0.3-63A/ 480Y/277V	N63UM	UL SF

Standard Pack: 6

Weight:

0.775kg (1.71lb.)

Standard Dual Connection Terminal

- Box clamp terminals
Top: 18-3 AWG;
Bottom: 18-2 AWG
(Line/Load reversible)
- Ring tongue terminals

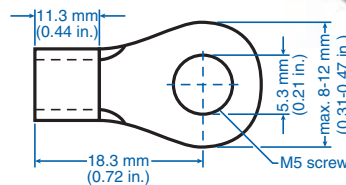
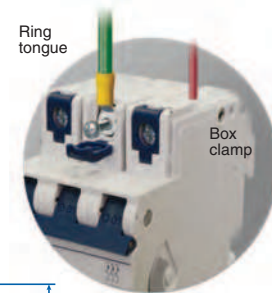

* May differ by manufacturer. Top terminal ring tongue max. thickness 1.6mm.

UL 489

UL 508

UL 1077

UL 1077
Equipment Breakers

Earth Leakage
Circuit Breakers

ANNEX

V-EA Series

G-Trip

Characteristic

Application Examples:

General industrial, including motors, some transformers, solenoids, control circuits, lighting and wiring. Meets the US trip norms with relatively short thermal trip delay and high magnetic trip point.



UL508 Listed
E137938



Standard Pack: 12

Weight:

0.3A - 32A

1.75kg (3.86 lb.)

40A - 63A

2.07kg (4.56 lb.)

One Pole

Rated Current	Type/ Cat. No.	Approvals
0.3A	1G03UM	UL SF
0.5A	1G05UM	UL SF
0.8A	1G08UM	UL SF
1.0A	1G1UM	UL SF
1.6A	1G1.6UM	UL SF
2.0A	1G2UM	UL SF
2.5A	1G2.5UM	UL SF
3.0A	1G3UM	UL SF
3.5A	1G3.5UM	UL SF
4.0A	1G4UM	UL SF
5.0A	1G5UM	UL SF
6.0A	1G6UM	UL SF
8.0A	1G8UM	UL SF
10A	1G10UM	UL SF
12A	1G12UM	UL SF
13A	1G13UM	UL SF
15A	1G15UM	UL SF
16A	1G16UM	UL SF
20A	1G20UM	UL SF
25A	1G25UM	UL SF
30A	1G30UM	UL SF
32A	1G32UM	UL SF
40A	1G40UM	UL SF
50A	1G50UM	UL SF
60A	1G60UM	UL SF
63A	1G63UM	UL SF



Standard Pack: 4

Weight:

0.3A - 32A

1.75kg (3.86 lb.)

40A - 63A

2.07kg (4.56 lb.)

Three Pole

Rated Current	Type/ Cat. No.	Approvals
0.3A	3G03UM	UL SF
0.5A	3G05UM	UL SF
0.8A	3G08UM	UL SF
1.0A	3G1UM	UL SF
1.6A	3G1.6UM	UL SF
2.0A	3G2UM	UL SF
2.5A	3G2.5UM	UL SF
3.0A	3G3UM	UL SF
3.5A	3G3.5UM	UL SF
4.0A	3G4UM	UL SF
5.0A	3G5UM	UL SF
6.0A	3G6UM	UL SF
8.0A	3G8UM	UL SF
10A	3G10UM	UL SF
12A	3G12UM	UL SF
13A	3G13UM	UL SF
15A	3G15UM	UL SF
16A	3G16UM	UL SF
20A	3G20UM	UL SF
25A	3G25UM	UL SF
30A	3G30UM	UL SF
32A	3G32UM	UL SF
40A	3G40UM	UL SF
50A	3G50UM	UL SF
60A	3G60UM	UL SF
63A	3G63UM	UL SF



Standard Pack: 6

Weight:

0.3A - 32A

1.75kg (3.86 lb.)

40A - 63A

2.07kg (4.56 lb.)

Two Pole

Rated Current	Type/ Cat. No.	Approvals
0.3A	2G03UM	UL SF
0.5A	2G05UM	UL SF
0.8A	2G08UM	UL SF
1.0A	2G1UM	UL SF
1.6A	2G1.6UM	UL SF
2.0A	2G2UM	UL SF
2.5A	2G2.5UM	UL SF
3.0A	2G3UM	UL SF
3.5A	2G3.5UM	UL SF
4.0A	2G4UM	UL SF
5.0A	2G5UM	UL SF
6.0A	2G6UM	UL SF
8.0A	2G8UM	UL SF
10A	2G10UM	UL SF
12A	2G12UM	UL SF
13A	2G13UM	UL SF
15A	2G15UM	UL SF
16A	2G16UM	UL SF
20A	2G20UM	UL SF
25A	2G25UM	UL SF
30A	2G30UM	UL SF
32A	2G32UM	UL SF
40A	2G40UM	UL SF
50A	2G50UM	UL SF
60A	2G60UM	UL SF
63A	2G63UM	UL SF



Add-on Neutral Pole

Rated Current	Type/ Cat. No.	Approvals
0.3-63A/ 480Y/277V	N63UM	UL SF

Standard Pack: 6

Weight:

0.775kg (1.71lb.)

Standard Dual Connection Terminal

- Box clamp terminals
Top: 18-3 AWG;
Bottom: 18-2 AWG
(Line/Load reversible)
- Ring tongue terminals

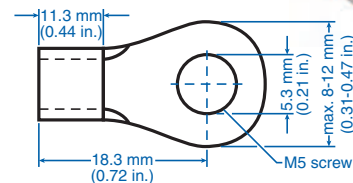
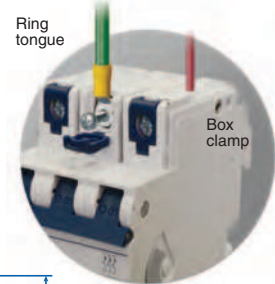

* May differ by manufacturer. Top terminal ring tongue max. thickness 1.6mm.

V-EA Series Z-Trip Characteristic

Application Examples:

Semiconductors, components which fail-short (vs. fail-open), and components/devices with low surge-current and short circuit withstand capabilities. Relatively short thermal delay and very low magnetic trip point.



UL 489

UL 508

UL 1077

UL 1077
Equipment Breakers

Earth Leakage
Circuit Breakers

ANNEX

One Pole



Standard Pack: 12

Weight:
0.3A - 32A
1.75kg (3.86 lb.)
40A - 63A
2.07kg (4.56 lb.)

Rated Current	Type/ Cat. No.	Approvals
0.3A	1Z03UM	UL Ⓢ
0.5A	1Z05UM	UL Ⓢ
0.75A	1Z075UM	UL Ⓢ
1.0A	1Z1UM	UL Ⓢ
1.6A	1Z1.6UM	UL Ⓢ
2.0A	1Z2UM	UL Ⓢ
2.5A	1Z2.5UM	UL Ⓢ
3.0A	1Z3UM	UL Ⓢ
3.5A	1Z3.5UM	UL Ⓢ
4.0A	1Z4UM	UL Ⓢ
5.0A	1Z5UM	UL Ⓢ
6.0A	1Z6UM	UL Ⓢ
8.0A	1Z8UM	UL Ⓢ
10A	1Z10UM	UL Ⓢ
12A	1Z12UM	UL Ⓢ
13A	1Z13UM	UL Ⓢ
15A	1Z15UM	UL Ⓢ
16A	1Z16UM	UL Ⓢ
20A	1Z20UM	UL Ⓢ
25A	1Z25UM	UL Ⓢ
30A	1Z30UM	UL Ⓢ
32A	1Z32UM	UL Ⓢ
40A	1Z40UM	UL Ⓢ
50A	1Z50UM	UL Ⓢ

Three Pole



Standard Pack: 4

Weight:
0.3A - 32A
1.75kg (3.86 lb.)
40A - 63A
2.07kg (4.56 lb.)

Rated Current	Type/ Cat. No.	Approvals
0.3A	3Z03UM	UL Ⓢ
0.5A	3Z05UM	UL Ⓢ
0.75A	3Z075UM	UL Ⓢ
1.0A	3Z1UM	UL Ⓢ
1.6A	3Z1.6UM	UL Ⓢ
2.0A	3Z2UM	UL Ⓢ
2.5A	3Z2.5UM	UL Ⓢ
3.0A	3Z3UM	UL Ⓢ
3.5A	3Z3.5UM	UL Ⓢ
4.0A	3Z4UM	UL Ⓢ
5.0A	3Z5UM	UL Ⓢ
6.0A	3Z6UM	UL Ⓢ
8.0A	3Z8UM	UL Ⓢ
10A	3Z10UM	UL Ⓢ
12A	3Z12UM	UL Ⓢ
13A	3Z13UM	UL Ⓢ
15A	3Z15UM	UL Ⓢ
16A	3Z16UM	UL Ⓢ
20A	3Z20UM	UL Ⓢ
25A	3Z25UM	UL Ⓢ
30A	3Z30UM	UL Ⓢ
32A	3Z32UM	UL Ⓢ
40A	3Z40UM	UL Ⓢ
50A	3Z50UM	UL Ⓢ

Two Pole



Standard Pack: 6

Weight:
0.3A - 32A
1.75kg (3.86 lb.)
40A - 63A
2.07kg (4.56 lb.)

Rated Current	Type/ Cat. No.	Approvals
0.3A	2Z03UM	UL Ⓢ
0.5A	2Z05UM	UL Ⓢ
0.75A	2Z075UM	UL Ⓢ
1.0A	2Z1UM	UL Ⓢ
1.6A	2Z1.6UM	UL Ⓢ
2.0A	2Z2UM	UL Ⓢ
2.5A	2Z2.5UM	UL Ⓢ
3.0A	2Z3UM	UL Ⓢ
3.5A	2Z3.5UM	UL Ⓢ
4.0A	2Z4UM	UL Ⓢ
5.0A	2Z5UM	UL Ⓢ
6.0A	2Z6UM	UL Ⓢ
8.0A	2Z8UM	UL Ⓢ
10A	2Z10UM	UL Ⓢ
12A	2Z12UM	UL Ⓢ
13A	2Z13UM	UL Ⓢ
15A	2Z15UM	UL Ⓢ
16A	2Z16UM	UL Ⓢ
20A	2Z20UM	UL Ⓢ
25A	2Z25UM	UL Ⓢ
30A	2Z30UM	UL Ⓢ
32A	2Z32UM	UL Ⓢ
40A	2Z40UM	UL Ⓢ
50A	2Z50UM	UL Ⓢ

Add-on Neutral Pole



Rated Current	Type/ Cat. No.	Approvals
0.3-63A/ 480Y/277V	N63UM	UL Ⓢ

Standard Pack: 6

Weight:
0.775kg (1.71lb.)

Standard Dual Connection Terminal

- Box clamp terminals
Top: 18-3 AWG;
Bottom: 18-2 AWG
(Line/Load reversible)
- Ring tongue terminals

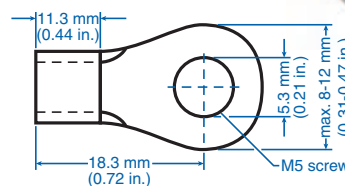
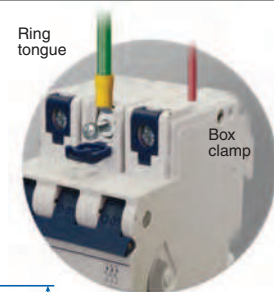

* May differ by manufacturer. Top terminal ring tongue max. thickness 1.6mm.

V-EA Trip Curves

B Trip Curve

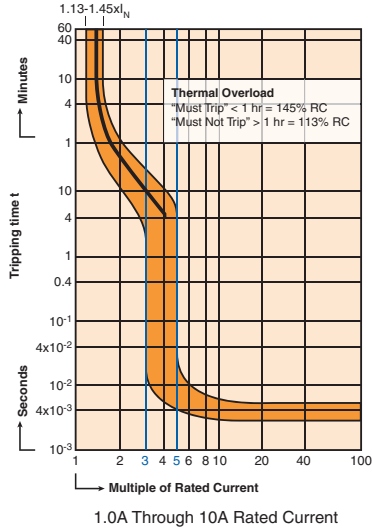

C Trip Curve

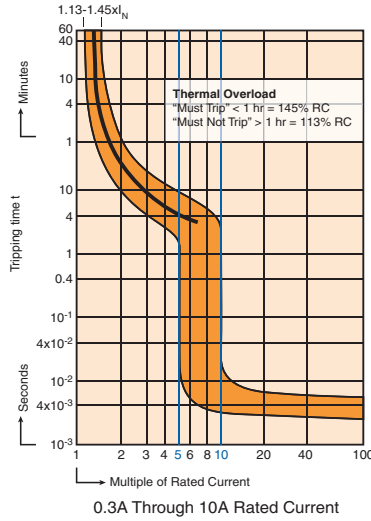

D Trip Curve

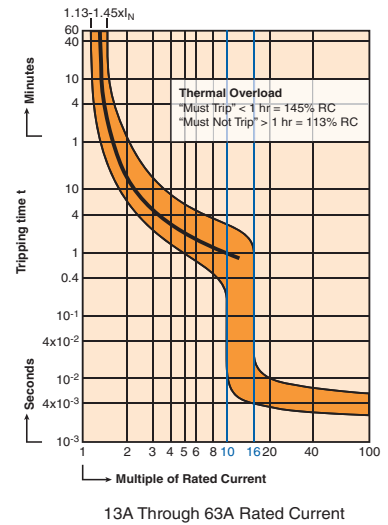
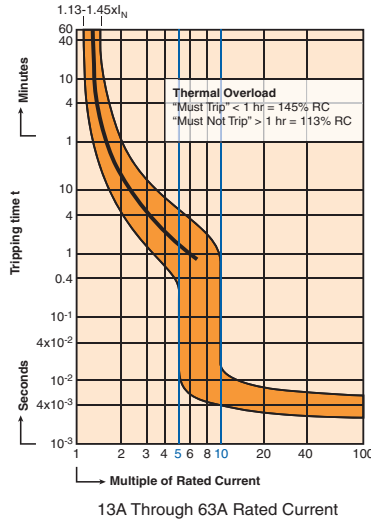
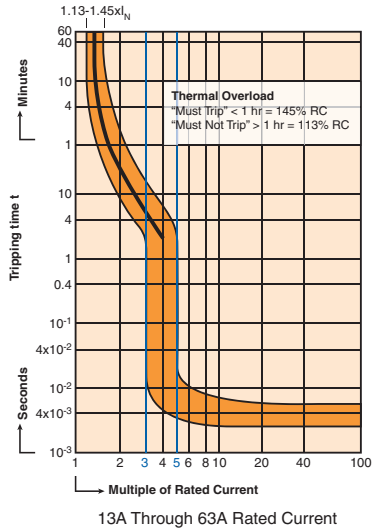
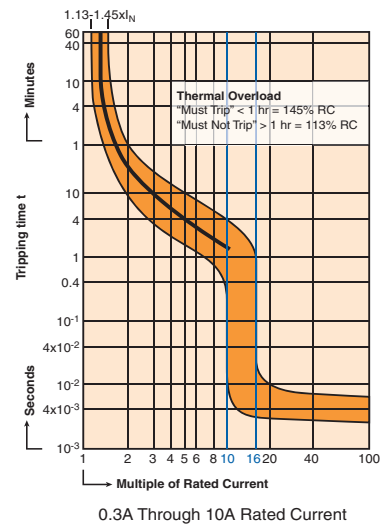

"B" Magnetic Trip Parameters

Rated current 1.0A to 63A.

1. Hold for a minimum of 100ms at surge of 3 times rated current.
2. Trip in under 100ms at 5 times rated current.

"C" Magnetic Trip Parameters

Rated current 0.3A to 63A.

1. Hold for a minimum of 100ms at surge of 5 times rated current.
2. Trip in under 100ms at 10 times rated current.

"D" Magnetic Trip Parameters

Rated current 0.3A to 63A.

1. Hold for a minimum of 100ms at surge of 10 times rated current.
2. Trip in under 100ms at 16 times rated current.

V-EA Trip Curves

E Trip Curve

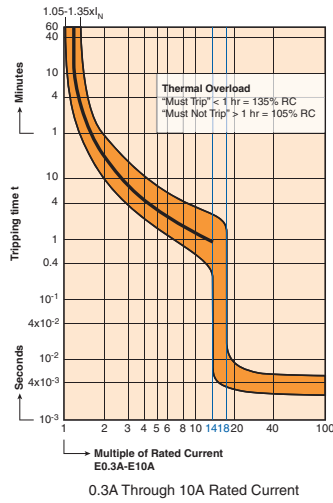

G Trip Curve

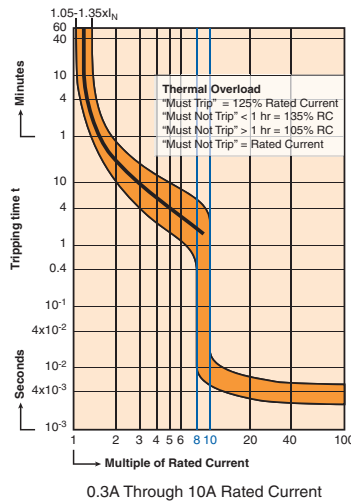

Z Trip Curve

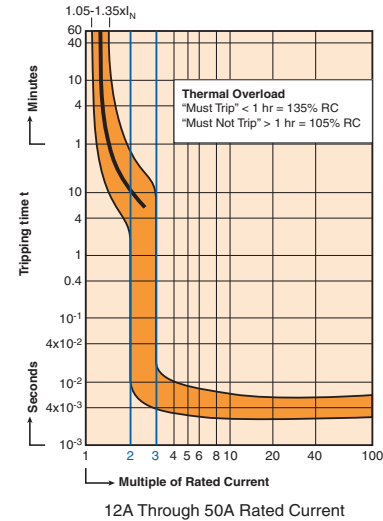
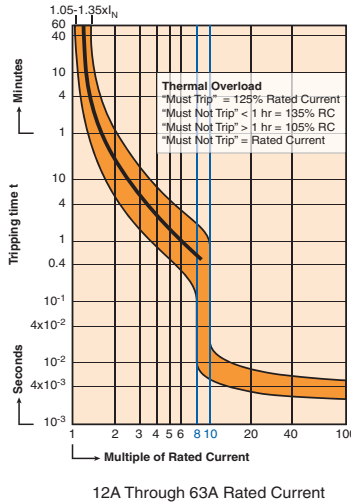
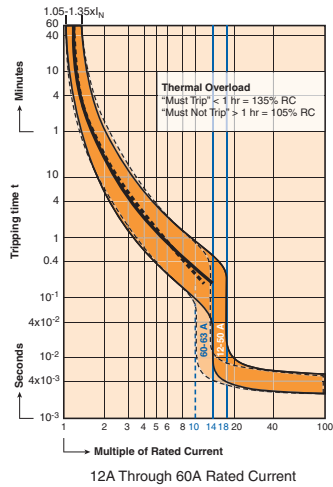
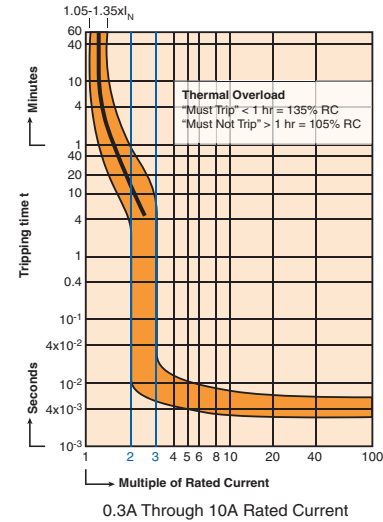

“E” Magnetic Trip Parameters
Rated Current, 0.3A to 50A,
60/63A (dotted line).

Magnetic Trip:

1. Hold for a minimum of 100ms at surge of 14 times (60A, 10 times) rated current.
2. Trip in under 100ms at 18 times (60A, 14 times) rated current.

“G” Magnetic Trip Parameters
Rated Current, 0.3A to 63A.

Magnetic Trip:

1. Hold for a minimum of 100ms at surge of 8 times rated current.
2. Trip in under 100ms at 10 times rated current.

“Z” Trip Parameters
Rated Current, 0.3A to 50A.

Magnetic Trip:

1. Hold for a minimum of 100ms at 2 times rated current.
2. Trip in under 100ms at 3 times rated current.

Table HP 1: AMPERE RATINGS & HORSEPOWER RATING 1 PHASE

			FLA & LRC CONVERTED TO TABLE HORSEPOWER (SEE NOTE #2) USE FLA & LRC RATINGS WHERE NO HP RATING IS GIVEN					
			NOMINAL CIRCUIT VOLTAGE					
V-EA RATED	MOTOR NAMEPLATE	MOTOR NAMEPLATE	110-120 VAC	200 VAC	208 VAC	220-240 VAC	265 VAC	277 VAC
CURRENT (SEE NOTE #1)	FLA RATING	STARTING/ LRC RATING						
0.30A 0.50A 0.75A	0.30A 0.50A 0.75A	1.80A 3.00A 4.35A						
0.80A 1.0A 1.6A	0.80A 1.0A 1.6A	4.8A 6.0A 9.6A						
2.0A 2.5A 3.0A	2.0A 2.5A 3.0A	12.0A 15.0A 18.0A		1/6hp 1/6hp	1/6hp 1/6hp	1/6hp 1/6hp 1/4hp	1/6hp 1/6hp 1/4hp	1/6hp 1/4hp 1/3hp
3.5A 4.0A	3.5A 4.0A	21.0A 24.0A		1/4hp 1/4hp	1/4hp 1/3hp	1/4hp 1/3hp	1/3hp 1/3hp	1/3hp 1/3hp
5.0A 6.0A 8.0A	5.0A 6.0A 8.0A	30.0A 36.0A 48.0A	1/6hp 1/4hp 1/3hp	1/3hp 1/2hp 3/4hp	1/2hp 1/2hp 3/4hp	1/2hp 1/2hp 1hp	1/2hp 3/4hp 1hp	1/2hp 3/4hp 1hp
10.0A	10.0A	60.0A	1/2hp	1hp	1hp	11/2hp	11/2hp	2hp
12.0A 12.5A	12.0A 12.5A	72.0A 75.0A	1/2hp 1/2hp	11/2hp 11/2hp	11/2hp 11/2hp	2hp 2hp	2hp 2hp	2hp 2hp
13.0A 15.0A 16.0A	13.0A 15.0A 16.0A	78.0A 90.0A 96.0A	1/2hp 3/4hp 1hp	11/2hp 2hp 2hp	11/2hp 2hp 2hp	2hp 2hp 2hp	2hp 3hp 3hp	2hp 3hp 3hp
20.0A 25.0A	20.0A 25.0A	120.0A 150.0A	11/2hp 2hp	3hp 3hp	3hp 3hp	3hp 3hp	3hp 5hp	3hp 5hp
30.0A	30.0A	180.0A	2hp	3hp	3hp	5hp	5hp	5hp
32.0A	32.0A	192.0A	2hp	3hp	5hp	5hp	5hp	5hp
40.0A	40.0A	240.0A	3hp	5hp	71/2hp	71/2hp	71/2hp	71/2hp
50.0A 60.0A	50.0A 60.0A	300.0A 360.0A	3hp 5hp	71/2hp 10hp	10hp 10hp	10hp 10hp	10hp 10hp	10hp 15hp

NOTE #1: For AC motor circuit nameplate full load current, AC general-use loads, AC resistance loads, AC incandescent lamp (tungsten) loads, AC electric discharge lamp (ballast) loads.
NOTE #2: Conversions per UL508® Table 45.2 and NFPA-70: National Electrical Code® 2011 Tables 430-248 and 430-251(A).

TABLE HP 2: AMPERE RATING & HORSEPOWER RATING 3 PHASE & 2 PHASE - 4 WIRE

FLA & LRC RATINGS CONVERTED TO TABLE HORSEPOWER (SEE NOTE #2) USE FLA & LRC RATINGS WHERE NO HP IS LISTED												
V-EA RATED CURRENT (SEE NOTE #1)	MOTOR NAMEPLATE FLA RATING	MOTOR NAMEPLATE STARTING/ LRC RATING	110-120 VAC		200 VAC		208 VAC		220-240 VAC (SEE NOTE #3)		440-480 VAC	
			Motor Design		Motor Design		Motor Design		Motor Design		Motor Design	
			B, C, D	E	B, C, D	E	B, C, D	E	B, C, D	E	B, C, D	E
0.30A 0.50A 0.75A	0.30A 0.50A 0.75A	3.0A 5.0A 7.5A										
0.80A 1.0A 1.6A	0.80A 1.0A 1.6A	8.0A 10.0A 16.0A									1/2hp	1/2hp
2.0A 2.5A 3.0A	2.0A 2.5A 3.0A	20.0A 25.0A 30.0A			1/2hp 1/2hp	1/2hp 1/2hp	1/2hp 1/2hp	1/2hp 1/2hp	1/2hp 1/2hp 1/2hp	1/2hp 1/2hp 1/2hp	3/4hp 1hp 11/2hp	3/4hp 1hp 11/2hp
3.5A 4.0A	3.5A 4.0A	35.0A 40.0A			1/2hp 3/4hp	1/2hp 3/4hp	3/4hp 3/4hp	3/4hp 3/4hp	3/4hp 3/4hp	3/4hp 3/4hp	2hp 2hp	2hp 2hp
5.0A 6.0A 8.0A	5.0A 6.0A 8.0A	42.0A 50.4A 67.2A	1/2hp 1/2hp 3/4hp	1/2hp 1/2hp 3/4hp	1hp 1hp 2hp	1hp 1hp 2hp	1hp 1hp 2hp	1hp 1hp 2hp	1hp 1hp 2hp	1hp 11/2hp 2hp	1hp 11/2hp 5hp	3hp 3hp 5hp
10.0A 12.0A 12.5A	10.0A 12.0A 12.5A	84.0A 100.8A 105.0A	1hp 11/2hp 11/2hp	1hp 11/2hp 11/2hp	2hp 3hp 3hp	2hp 3hp 3hp	2hp 3hp 3hp	2hp 3hp 3hp	3hp 3hp 3hp	3hp 3hp 3hp	5hp 71/2hp 71/2hp	5hp 71/2hp 71/2hp
13.0A 15.0A 16.0A	13.0A 15.0A 16.0A	109.2A 126.0A 134.4A	11/2hp 2hp 2hp	11/2hp 2hp 2hp	3hp 3hp 3hp	3hp 3hp 3hp	3hp 3hp 3hp	3hp 3hp 3hp	3hp 3hp 5hp	3hp 3hp 5hp	71/2hp 10hp 10hp	71/2hp 10hp 10hp
20.0A 25.0A	20.0A 25.0A	168.0A 210.0A	3hp 3hp	3hp 3hp	5hp 5hp	5hp 5hp	5hp 71/2hp	5hp 71/2hp	5hp 71/2hp	5hp 71/2hp	10hp 15hp	10hp 15hp
30.0A 32.0A 40.0A	30.0A 32.0A 40.0A	252.0A 268.8A 226.0A	5hp 5hp 5hp	5hp 5hp 5hp	5hp 5hp 10hp	5hp 5hp 10hp	71/2hp 10hp 10hp	71/2hp 10hp 10hp	10hp 10hp 10hp	10hp 10hp 10hp	20hp 20hp 30hp	20hp 20hp 20hp
50.0A 60.0A	50.0A 60.0A	282.5A 339.0A	71/2hp 10hp	71/2hp 10hp	15hp 15hp	10hp 10hp	15hp 20hp	10hp 10hp	15hp 20hp	10hp 15hp	30hp 40hp	25hp 30hp

NOTE #1: For AC motor circuit nameplate full load current, AC general-use loads, AC resistance loads, AC incandescent lamp (tungsten) loads, AC electric discharge lamp (ballast) loads.
NOTE #2: Conversions per UL508® proposed Tables 45.2 and 45.4 and NFPA-70: National Electrical Code® 2011 Tables 430-249, 430-250 and 430-251(B).

V-EA INTERNAL RESISTANCE

Rated Current (Amp)	Trip Characteristic					
	B (Ohms)	C (Ohms)	D (Ohms)	E (Ohms)	G (Ohms)	Z (Ohms)
0.3	—	16.8620	16.8620	14.52000	16.8620	31.5060
0.5	—	6.8540	6.0009	5.92000	6.8540	10.2460
0.75/0.8	—	3.0540	3.0540	2.70000	3.0540	5.3920
1.0	—	1.7000	1.7560	1.48000	1.7560	2.6910
1.6	—	0.5870	0.5870	0.57400	0.5870	0.9440
2.0	—	0.4190	0.4190	0.40500	0.4190	0.8900
2.5	—	0.2950	0.2950	0.26900	0.2950	0.4290
3.0	—	0.2020	0.2020	0.18600	0.2020	0.3460
3.5	—	0.1390	0.1390	0.13900	0.1390	0.1790
4.0	—	0.1090	0.1090	0.10600	0.1090	0.1620
5.0	—	0.0654	0.0654	0.05900	0.0654	0.1050
6.0	0.0528	0.0528	0.0491	0.04600	0.0491	0.0823
8.0	—	0.0278	0.0240	0.03040	0.0333	0.0371
10	0.0216	0.0216	0.0187	0.02020	0.0211	0.0278
12/12.5	—	—	—	0.00724	0.0084	0.0151
13	0.0113	0.0084	0.0085	0.00724	0.0084	0.0151
15/16	0.0085	0.0085	0.0076	0.00731	0.0076	0.0114
20	0.0067	0.0067	0.0064	0.00582	0.0064	0.0075
25	0.0050	0.0050	0.0041	0.00411	0.0046	0.0050
30/32	0.0032	0.0032	0.0027	0.00272	0.0030	0.0032
40	0.0025	0.0025	0.0022	0.00212	0.0022	0.0022
50	0.0019	0.0019	0.0018	0.00184	0.0019	0.00195
60/63	0.0018	0.0018	0.0017	0.00172	0.00179	—

Resistances listed are “hot” values, as opposed to cold start values. Operating voltage drop across the V-EA and power loss per pole can be approximated with basic formulas:

$$V_{DROD} = I_{OPERATING} \times R_{TABLE}$$

$$P_{LOSS P/P} = I_{OPERATING}^2 \times R_{TABLE}$$

Voltage drops should be reviewed when V-EAs with high internal resistance are used (e.g., load voltage minimums). Power loss should be reviewed when V-EAs with high rated currents are used (e.g., enclosure heating).

The listed V-EA internal resistance values should not be used in calculations of available short-circuit current downstream of the V-EA. The dynamic impedance of the V-EA under short-circuit conditions can vary significantly from internal resistance values in normal operation.

LINE CURRENT FREQUENCY EFFECTS ON TRIP CURVES

Frequency Effects on Magnetic Trip Curves					
Trip Curve	Trip Zone At 16 2/3 - 60Hz (x RC)	Trip Zone At 100 Hz (x RC)	Trip Zone At 200 Hz (x RC)	Trip Zone At 400 Hz (x RC)	Trip Zone At DC (x RC)
Z	2 - 3	2.2 - 3.3	2.4 - 3.6	2.8 - 4.2	3.0 - 4.5
B	3 - 5	3.3 - 5.5	3.6 - 6.0	4.2 - 7.0	4.5 - 7.5
C	5 - 10	5.5 - 11.0	6.0 - 12	7.0 - 14.0	7.5 - 15.0
G	8 - 10	8.8 - 11.0	9.6 - 12.0	11.2 - 14.0	12.0 - 15.0
D	10 - 16	11.0 - 17.6	12.0 - 19.2	14.0 - 22.4	15.0 - 24.0
E	14 - 18	15.4 - 19.8	16.8 - 21.6	19.6 - 25.2	21.0 - 27.0

The thermal trip is not affected by the frequency of the line current. The magnetic trip is within the trip zone of the characteristic curve for frequencies from 16 2/3 to 60Hz. At lower and higher frequencies, the magnetic trip will be delayed longer than indicated by the characteristic curve, roughly as follows:

- At 100Hz: Mag. Trip Current = 1.1 x curve current
- At 200Hz: Mag. Trip Current = 1.2 x curve current
- At 400Hz: Mag. Trip Current = 1.4 x curve current
- At DC: Mag. Trip Current = 1.5 x curve current

For example, at 16 2/3 - 60 Hz the magnetic trip zone for the “G” characteristic is 8 to 10 times the rated current of the specific V-EA (i.e., hold for at least 100ms at 8 x RC, trip in less than 100ms at 10 x RC). With a 400Hz current, a magnetic trip at 10 x RC would be greatly delayed (thermal would likely trip first), as the magnetic trip zone is now 11.2 to 14 x RC. If a quicker magnetic trip is required with 400Hz, the “B” or “C” characteristic should be considered.

MECHANICAL ENDURANCE RATINGS (ON/OFF OPERATIONS)

Application	2 x (1.15 x RC)	2 x RC	RC	No Load	Total
AC General Use	—	6,000	—	4,000	10,000
AC Motor Starting Across the Line	1,000	—	5,000	4,000	10,000
AC Incandescent Lamps (Tungsten)	—	—	6,000	4,000	10,000
AC Electrical Discharge Lamps (Ballast)	—	6,000	—	4,000	10,000
AC Resistance	—	6,000	—	4,000	10,000

Manufacturers self certification 20000 ON/OFF operations with no load

UL 489

UL 508

UL 1077

UL 1077
Equipment Breakers

Earth Leakage
Circuit Breakers

ANNEX

MA-Series

Three Phase Adjustable Trip Miniature Circuit Breakers/ Manual Motor Controllers

The MA was designed to handle the high inrush loads of 3 phase transformers, power supplies, motors, etc. The MA protects wiring and equipment from damage caused by the three major classes of over-current, yet greatly reduces the number of nuisance trips in high starting and inrush current circuits.

An IEC device with excellent ratings under a UL listing at 480Y/277V (including group ratings) and at 500V under international standards, the Altech/ABL Sursum MA provides short and long term cost effective circuit protection for USA and/or export applications. The short term advantages include: (1) adjustable thermal trip allows finalization of initial designs before procurement of the load equipment is complete; (2) snap-on mounting for readily available, internationally standardized DIN Rail saves panel layout design time as well as installation and change labor; (3) large cage-clamp terminals with screws suitable to power screwdrivers, simplifies and speeds wiring; (4) convenient switched disconnect during factory testing and/or initial start-up saves time and aggravation. The key long term advantage is customer satisfaction and proven over-current protection of wiring and equipment (and the lack of rework/repair costs).



UL508 listed
E137938



CAN/CSA-C22.2 No.14 certified



Type Designation

MA 16 U M
(a) (b) (c) (d)

- (a) = MA - Manual Motor Controller
(b) = Rated Current
(c) = U - US Housing
 = R - US Housing + Ring Tongue
(d) = M - Part No. Designation

Voltage Rating	480Y/277V AC
AIC (Interrupt Capacity)	0.16A-2.5A: 42kA; 4.0A-16A: 14kA; 20A-40A: 10kA
Standard Short Circuit Withstand Rating (UL/CSA Ratings)	0.16A-2.5A: 42kA; 4.0A-16A: 14kA; 20A-40A: 10kA
Group Short Circuit Ratings (UL/CSA Ratings)	see above
Typical Life	6,000 on/off operations with 2xRC
Calibration Temperature	25°C, +0°, -5° (77°F, +0° -9°)
Standard Pack and Weight	1/450g (1.0 lb.)
Terminal Size Acceptability	Top/Bottom: 18-3 AWG
Terminal Torque (min/max)	2 Nm (17.7 lb.in.) / 2.5Nm (22.2 lb.in)

Cat. No.	Rated Current	FLA Dial Adjustment Markings	GROUP SHORT CIRCUIT RATING AT 480VAC ^a (and BCP size)	3Ø HORSEPOWER RATINGS AT NOMINAL LINE VOLTAGE (See Note for HEA Definition)				
				110-120V HP (HEA)	200V HP (HEA)	208V HP (HEA)	220-240V HP (HEA)	460-480V HP (HEA)
MA016UM	0.16A	0.1/ 0.12/0.14/0.16	42kARMS symmetrical (max. 1200A MCCB or RK5)					
MA025UM	0.25A	0.16/0.19/0.22/0.25						
MA040UM	0.40A	0.25/0.30/0.35/0.40						
MA063UM	0.63A	0.40/0.48/0.56/0.63						
MA1.0UM	1.0A	0.63/0.75/0.87/1.0						
MA1.6UM	1.6A	1.0/1.2/1.4/1.6						
MA2.5UM	2.5A	1.6/1.9/2.2/2.5						
MA4.0UM	4.0A	2.5/3.0/3.5/4.0	14kARMS symmetrical (max. 350A MCCB or RK5)	1/2 (4.0)	3/4 (3.2)	3/4 (3.1)	1 (3.6)	2 (3.42)
MA6.3UM	6.3A	4.0/4.8/5.6/6.3		3/4 (5.6)	1 1/2 (6.0)	1 1/2 (5.7)	1 1/2 (5.2)	3 (4.8)
MA10UM	10A	6.3/7.5/8.7/10		1 (7.2)	2 (7.8)	2 (7.5)	3 (9.6)	5 (7.6)
MA16UM	16A	10/12/14/16	10kARMS symmetrical (max. 350A MCCB or RK5)	2 (13.6)	3 (11.0)	3 (10.6)	5 (15.2)	10 (14.0)
MA20UM	20A	16/17/18.5/20		3 (19.2)	5 (17.5)	5 (16.7)	5 (15.2)	10 (14.0)
MA25UM	25A	20/21.5/23/25		3 (19.2)	5 (17.5)	7 1/2 (24.2)	7 1/2 (22.0)	15 (21.0)
MA32UM	32A	25/27/30/32	10kARMS symmetrical (max. 350A MCCB or RK5)	5 (30.4)	7 1/2 (25.0)	7 1/2 (24.2)	10 (28.0)	20 (27.0)
MA40UM	40A	32/34/37/40		5 (30.4)	10 (32.0)	10 (31.0)	10 (28.0)	25 (34.0)

Note: HEA - Horsepower Equivalent Amperes, the nominal amperage assigned to standard motor horsepower ratings in design guide tables such as NFPA-70 Tables 430-248, 430-249, 430-250; UL1077 Table 16.2; CSA - C22.2 No. 235-M89 Tables 44 and 45; CSA-C22.2 No. 14-M91 Table 19, etc. Multiply HEA values (in parenthesis) by 1.1 if power factor is 90%, and by 1.2 if power factor is 80%.

^a The standard-circuit short-circuit rating is 14kA for all types. Group ratings can be used in a standard circuit (e.g., MA1.0U at 42kA), but a higher standard rating cannot be used in a group circuit (e.g., MA40U at 14kA only in standard circuit.)

Dimensions in mm

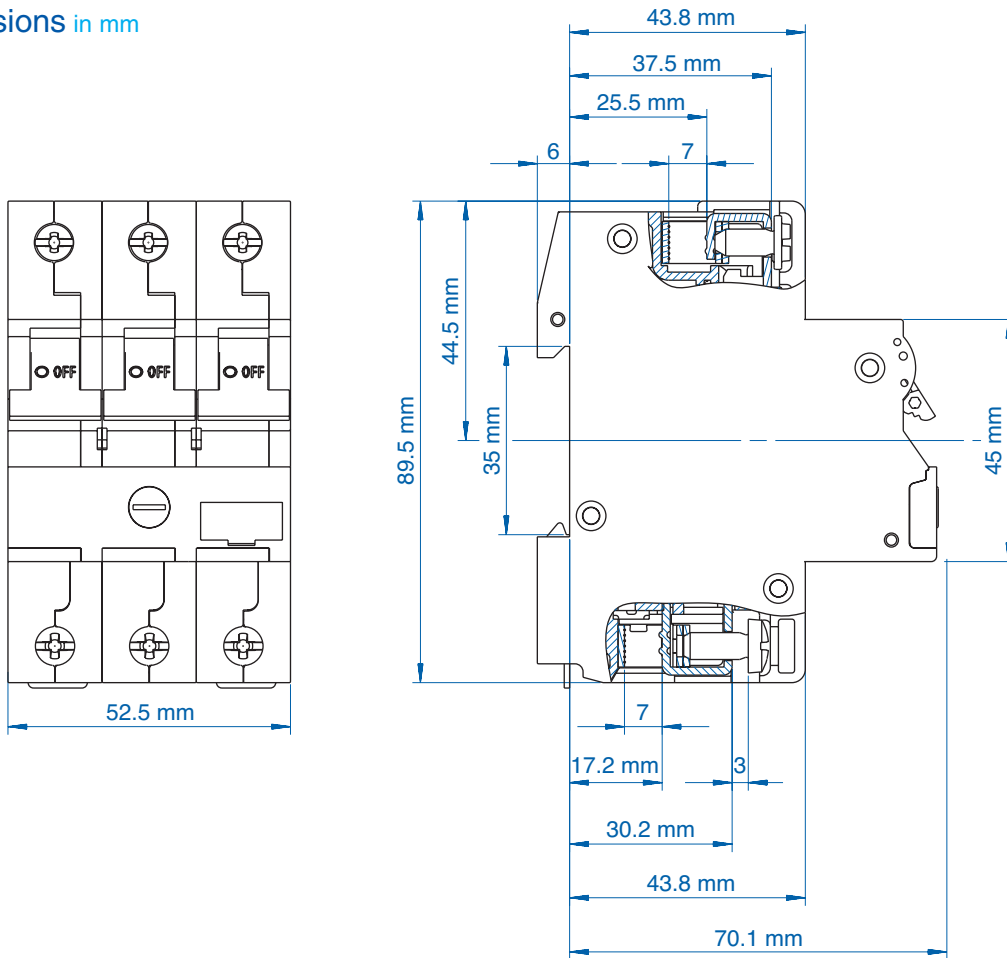

MA- Series Trip Curves

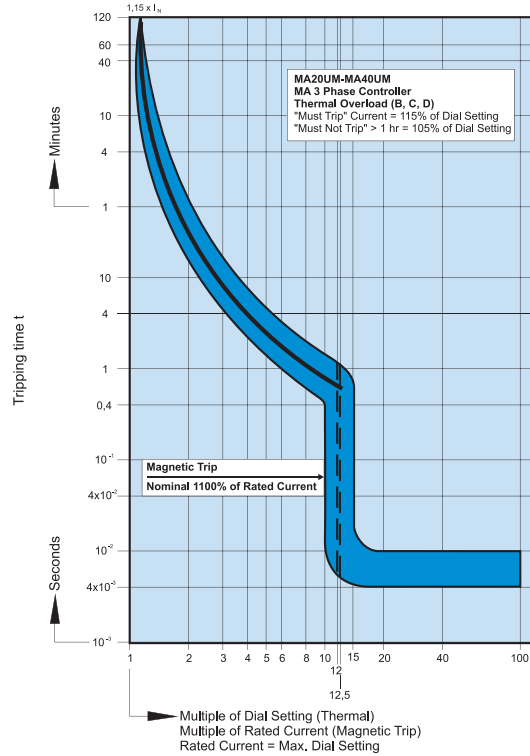
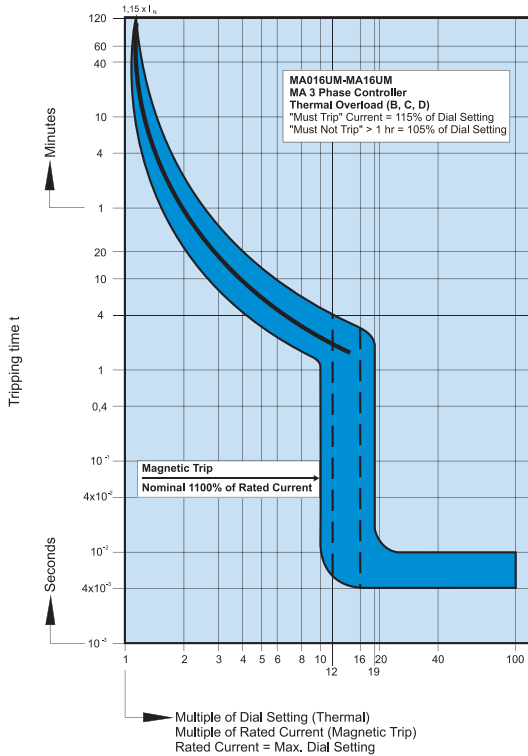

MA/USA Manual Motor Controller

UL 489

UL 508

UL 1077

UL 1077
Equipment Breakers

Earth Leakage
Circuit Breakers

ANNEX

UM (V-EA) and MA Accessories

For mounting instructions please refer to page 43.



UL Listed
E137938

Auxiliary Contact, Alarm Switch



Type/ Cat No.	Description	Contacts Type	Std Pk
H10UM	1 Auxiliary Contact	1NO	6
H11UM	2 Auxiliary Contacts	1NO + 1NC	6
H12UM	3 Auxiliary Contacts	1NO + 2NC	6
H21UM	3 Auxiliary Contacts	2NO + 1NC	6
HLS11M*	1 Auxiliary/1 Signal Contacts	1CO + 1CO (Signal)	6

Rated Operating Currents
10A @ 240V AC
3A @ 110V DC
1A @ 220V DC

Minimum Contact Load 1mA @ 24V DC

Torque max. 0.8Nm (7 lb.in)

Wire Range:

Single Wire 1.0mm² - 2.5mm² (18-14 AWG)

Stranded Wire 1.0mm² - 1.5mm² (18-16 AWG)

Stranded Wire with Ferrule 1.0mm² - 1.5mm² (18-16 AWG)

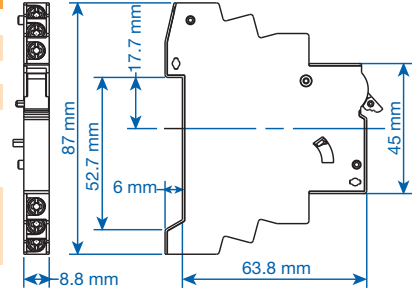

Dimensions HxxUM.



Shunt Trip

Type/ Cat No.	Rated Voltage U _N	Max. Operating Current @ U _N	Std Pk
FA12UM	12V AC/DC	1.3A	5
FA24UM	24V AC/DC	0.6A	5
FA48UM	48 - 72V AC/DC	0.2A	5
FA110UM	110 - 240V AC/DC, 277V AC	0.25A @ 110V 0.5A @ 240V 0.58A @ 277V	5

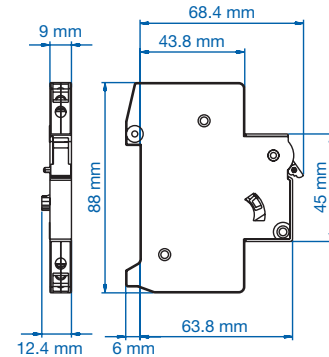

Dimensions HLS11M.



Undervoltage Trip*

Type/ Cat No.	Line Voltage V _E	Std Pk
UA120UM	120V AC, 60Hz	5

Reset-Hold Voltage = 0.85 x V_E

Drop-Out Voltage = 0.35 ~ 0.7 x V_E

V_E = Rated Voltage

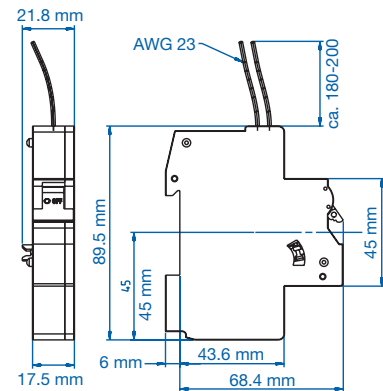

Dimensions UA120UM.

* Not UL approved. ** UM (V-EA) and MA can also be locked in the on and off position by simply using a common lead or meter seal, which gets fed through the hole in the handle and a corresponding hole in the housing.

UM (V-EA) and MA Accessories

For mounting instructions please refer to page 43.



Neutral Pole

Type/ Cat No.	Rated Current I_N	Rated Voltage U_N	Std Pk
N63UM	0.3 - 63A	480Y/277V AC	6

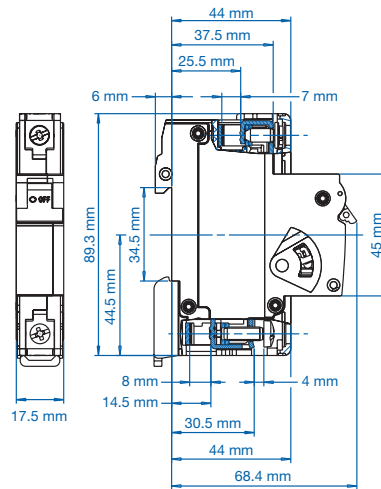

Dimensions N63UM, FxUM.



Touch Protection Caps

to cover the terminal screw holes on the switching devices, neutral Poles and shunt trips for increased touch protection.

Type/ Cat No.	Std Pk
BS.UL	100

Cooling Spacer



Type/ Cat No.	Std Pk
15.960	1



Mounting Screw 34mm

to connect the auxiliary contact and shunt trip or neutral Pole to the circuit breaker.

Type/ Cat No.	Std Pk
E983419	10



Lock-out Adapter**

Type/ Cat No.	Std Pk
EASS	10

UL 489

UL 508

UL 1077

UL 1077
Equipment Breakers

Earth Leakage
Circuit Breakers

ANNEX