



Chipsmall Limited consists of a professional team with an average of over 10 year of expertise in the distribution of electronic components. Based in Hongkong, we have already established firm and mutual-benefit business relationships with customers from,Europe,America and south Asia,supplying obsolete and hard-to-find components to meet their specific needs.

With the principle of “Quality Parts,Customers Priority,Honest Operation,and Considerate Service”,our business mainly focus on the distribution of electronic components. Line cards we deal with include Microchip,ALPS,ROHM,Xilinx,Pulse,ON,Everlight and Freescale. Main products comprise IC,Modules,Potentiometer,IC Socket,Relay,Connector.Our parts cover such applications as commercial,industrial, and automotives areas.

We are looking forward to setting up business relationship with you and hope to provide you with the best service and solution. Let us make a better world for our industry!



Contact us

Tel: +86-755-8981 8866 Fax: +86-755-8427 6832

Email & Skype: info@chipsmall.com Web: www.chipsmall.com

Address: A1208, Overseas Decoration Building, #122 Zhenhua RD., Futian, Shenzhen, China



RX frequency inverter

Customised to your machine

- Up to 132 kW
- High starting torque in open loop: 200% at 0.3Hz
- Full torque at 0 Hz in closed loop
- Sensor-less and vector closed-loop control
- Double rating VT 120%/1 min and CT 150%/1 min
- Built-in EMC filter
- Built-in application functionality
- Indexer functionality
- Automatic energy saving
- Micro-surge voltage suppression
- CE, cULus, RoHS

Ratings

- 200 V Class three-phase 0.4 to 55 kW
- 400 V Class three-phase 0.4 to 132 kW



System configuration

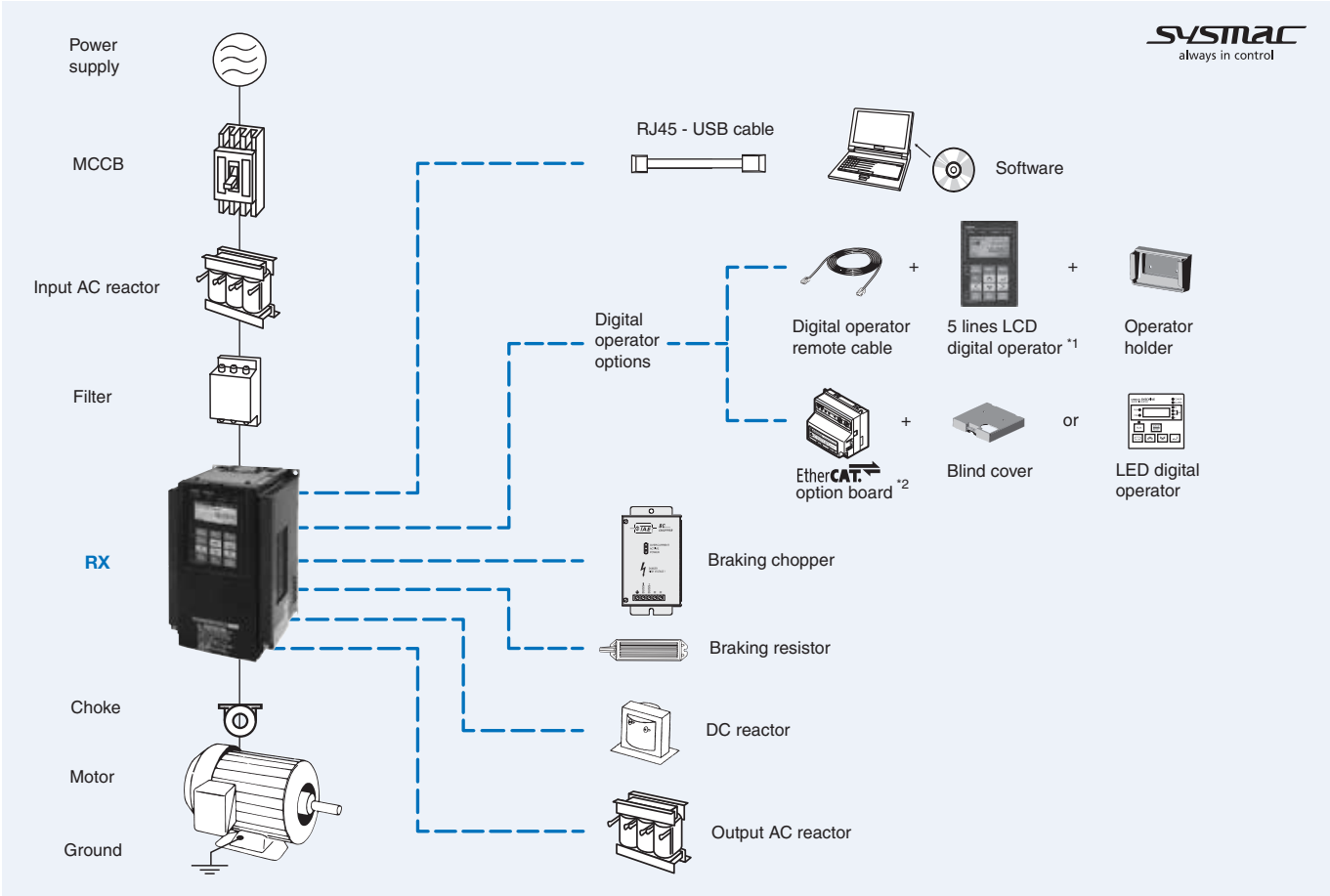

^{*1} The 5 lines LCD digital operator is provided with the inverter from factory.

^{*2} When a communication option board is mounted, there are two options: mount a blind cover or a LED digital operator.

Specifications

Type designation

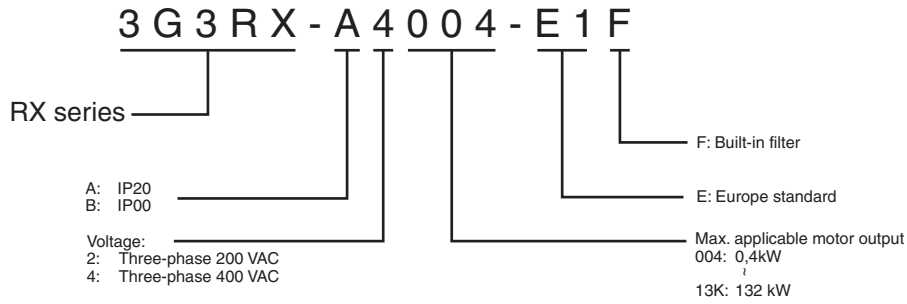

200 V class

Three-phase: 3G3RX-□		A2004	A2007	A2015	A2022	A2037	A2055	A2075	A2110	A2150	A2185	A2220	A2300	A2370	A2450	A2550		
Max. applicable motor 4P kW ^{*1}	at CT	0.4	0.75	1.5	2.2	3.7	5.5	7.5	11	15	18.5	22	30	37	45	55		
	at VT	0.75	1.5	2.2	3.7	5.5	7.5	11	15	18.5	22	30	37	45	55	75		
Output characteristics	Inverter capacity kVA	200 V	at CT	1.0	1.7	2.5	3.6	5.7	8.3	11	15.9	22.1	26.3	32.9	41.9	50.2	63	76.2
		at VT	1.3	2.1	3.2	4.1	6.7	10.4	15.2	20	26.3	29.4	39.1	49.5	59.2	72.7	93.5	
	240 V	at CT	1.2	2.0	3.1	4.3	6.8	9.9	13.3	19.1	26.6	31.5	39.4	50.2	60.2	75.6	91.4	
		at VT	1.5	2.6	3.9	5.0	8.1	12.4	18.2	24.1	31.5	35.3	46.9	59.4	71	87.2	112.2	
Rated output current (A)		at CT	3.0	5.0	7.5	10.5	16.5	24	32	46	64	76	95	121	145	182	220	
		at VT	3.7	6.3	9.4	12	19.6	30	44	58	73	85	113	140	169	210	270	
Max. output voltage		Proportional to input voltage: 0 to 240 V																
Max. output frequency		400 Hz																
Power supply	Rated input voltage and frequency		3-phase 200 to 240 V 50/60 Hz															
	Allowable voltage fluctuation		-15% to +10%															
	Allowable frequency fluctuation		5%															
Braking	Regenerative braking		Internal BRD circuit (external discharge resistor)													External regenerative braking unit		
	Minimum connectable resistance		50	50	35	35	35	16	10	10	7.5	7.5	5					
Protective structure		IP20																
Cooling method		Forced air cooling																

^{*1} Based on a standard 3-Phase standard motor.

400 V class

Three-phase: 3G3RX-□		A4004	A4007	A4015	A4022	A4040	A4055	A4075	A4110	A4150	A4185	A4220	A4300	A4370	A4450	A4550	B4750	B4900	B411K	B413K		
Max. applicable motor 4P kW ^{*1}	at CT	0.4	0.75	1.5	2.2	4.0	5.5	7.5	11	15	18.5	22	30	37	45	55	75	90	110	132		
	at VT	0.75	1.5	2.2	4.0	5.5	7.5	11	15	18.5	22	30	37	45	55	75	90	110	132	160		
Output characteristics	400 V	Inverter capacity kVA	at CT	1.0	1.7	2.5	3.6	6.2	9.7	13.1	17.3	22.1	26.3	33.2	40.1	51.9	63	77.6	103.2	121.9	150.3	180.1
			at VT	1.3	2.1	3.3	4.6	7.7	11	15.2	20.9	25.6	30.4	39.4	48.4	58.8	72.7	93.5	110.8	135	159.3	200.9
	480 V	at CT	1.2	2.0	3.1	4.3	7.4	11.6	15.8	20.7	26.6	31.5	39.9	48.2	62.3	75.6	93.1	128.3	146.3	180.4	216.1	
		at VT	1.5	2.5	4.0	5.5	9.2	13.3	18.2	24.1	30.7	36.5	47.3	58.1	70.6	87.2	112.2	133	162.1	191.2	241.1	
Rated output current (A)		at CT	1.5	2.5	3.8	5.3	9.0	14	19	25	32	38	48	58	75	91	112	149	176	217	260	
		at VT	1.9	3.1	4.8	6.7	11.1	16	22	29	37	43	57	70	85	105	135	160	195	230	290	
Max. output voltage		Proportional to input voltage: 0 to 480 V																				
Max. output frequency		400 Hz																				
Power supply	Rated input voltage and frequency		3-phase 380 to 480 V 50/60 Hz																			
	Allowable voltage fluctuation		-15% to +10%																			
	Allowable frequency fluctuation		5%																			
Braking	Regenerative braking		Internal BRD circuit (external discharge resistor)																External regenerative braking unit			
	Minimum connectable resistance		100	100	100	100	70	70	35	35	24	24	20									
Protective structure		IP20															IP00					
Cooling method		Forced air cooling																				

^{*1} Based on a standard 3-Phase standard motor.

Common specifications

Model number 3G3RX		Specifications				
Control functions	Motor control	Phase-to-phase sinusoidal pulse with modulation PWM (Sensorless vector control, close loop vector with motor feedback, V/F)				
	Control mode	Speed, torque and indexer functionality				
	Output frequency range	0.10 to 400.00 Hz				
	Frequency precision	Digital set value: $\pm 0.01\%$ of the max. frequency				
		Analogue set value: $\pm 0.2\%$ of the max. frequency ($25 \pm 10^\circ\text{C}$)				
	Resolution of frequency set value	Digital set value: 0.01 Hz				
		Analogue input: 12 bit				
	Resolution of output frequency	0.01Hz				
	Starting torque	150%/0.3 Hz (under sensor-less vector control or sensor-less vector control at 0 Hz)				
		200%/Torque at 0 Hz (under sensor-less vector control at 0Hz, when a motor size one rank lower than specified is connected)				
Overload capability	150%/60 s, 200%/3 s for CT; 120%/60 s VT					
Frequency set value	0 to 10 VDC (10 K Ω), -10 to 10 VDC (10 K Ω), 4 to 20 mA (100 Ω), EtherCAT communications					
V/f Characteristics	V/f optionally changeable at base frequencies of 30 to 400 Hz, V/f braking constant torque, reduction torque, sensor-less vector control, sensor-less vector control at 0 Hz					
Functionality	Inputs signals	8 terminals, NO/NC switchable, sink/source logic switchable [Terminal function] 8 functions can be selected from among 61. Reverse (RV), Multi-step speed setting binary 1 (CF1), Multi-step speed setting binary 2 (CF2), Multi-step speed setting binary 3 (CF3), Multi-step speed setting binary 4 (CF4), Jogging (JG), DC injection braking (DB), 2nd control (SET), 2-step acceleration/deceleration (2CH), Free-run stop (FRS), External trip (EXT), USP function (USP), Commercial switching (CS), Soft lock (SFT), Analog input switching (AT), 3rd control (SET3), Reset (RS), 3-wire start (STA), 3-wire stop (STP), 3-wire forward/reverse (F/R), PID enabled/disabled (PID), PID integral reset (PIDC), Control gain switching (CAS), UP/DWN function accelerated (UP), UP/DWN function decelerated (DWN), UP/DWN function data clear (UDC), Forced operator (OPE), Multi-step speed setting bit 1 (SF1), Multi-step speed setting bit 2 (SF2), Multi-step speed setting bit 3 (SF3), Multi-step speed setting bit 4 (SF4), Multi-step speed setting bit 5 (SF5), Multi-step speed setting bit 6 (SF6), Multi-step speed setting bit 7 (SF7), Overload limit switching (OLR), Torque limit enabled (TL), Torque limit switching 1 (TRQ1), Torque limit switching 2 (TRQ2), P/PI switching (PPI), Brake confirmation (BOK), Orientation (ORT), LAD cancel (LAC), Position deviation clear (PCLR), Pulse train position command input permission (STAT), Frequency addition function (ADD), Forced terminal block (F-TM), Torque reference input permission (ATR), Integrated power clear (KHC), Servo ON (SON), Preliminary excitation (FOC), Analog command on hold (AHD), Position command selection 1 (CP1), Position command selection 2 (CP2), Position command selection 3 (CP3), Zero return limit signal (ORL), Zero return startup signal (ORG), Forward driving stop (FOT), Reverse driving stop (ROT), Speed/Position switching (SPD), Pulse counter (PCNT), Pulse counter clear (PCC), No allocation (no)				
		Output signals	5 open collector output terminals: NO/NC switchable, sink/source logic switchable 1 relay (SPDT contact) output terminal: NO/NC switchable [Terminal function] 6 functions can be selected from among 45. Signal during RUN (RUN), Constant speed arrival signal (FA1), Over set frequency arrival signal (FA2), Overload warning (OL), Excessive PID deviation (OD), Alarm signal (AL), Set-frequency-only arrival signal (FA3), Overtorque (OTQ), Signal during momentary power interruption (IP), Signal during undervoltage (UV), Torque limit (TRQ), RUN time exceeded (RNT), Power ON time exceeded (ONT), Thermal warning (THM), Brake release (BRK), Brake error (BER), 0-Hz signal (ZS), Excessive speed deviation (DSE), Position ready (POK), Set frequency exceeded 2 (FA4), Set frequency only 2 (FA5), Overload warning 2 (OL2), Analog FV disconnection detection (FVDC), Analog FI disconnection detection (FIDc), Analog FE disconnection detection (FEDc), PID FB status output (FBV), Network error (NDc), Logic operation output 1 (LOG1), Logic operation output 2 (LOG2), Logic operation output 3 (LOG3), Logic operation output 4 (LOG4), Logic operation output 5 (LOG5), Logic operation output 6 (LOG6), Capacitor life warning (WAC), Cooling fan life warning (WAF), Starting contact signal (FR), Fin overheat warning (OHF), Light load detection signal (LOC), Operation ready (IRDY), Forward run (FWR), Reverse run (RVR), Fatal fault (MJA), Window comparator FV (WCFV), Window comparator FI (WCFI), Window comparator FE (WCFE), Alarm codes 0 to 3 (AC0 to AC3)			
			Standard functions	V/f free setting (7), Upper/lower frequency limit, Frequency jump, Curve acceleration/deceleration, Manual torque boost level/break, Energy-saving operation, Analog meter adjustment, Starting frequency, Carrier frequency adjustment, Electronic thermal function, (free setting available), External start/end (frequency/rate), Analog input selection, Trip retry, Restart during momentary power interruption, Various signal outputs, Reduced voltage startup, Overload limit, Initialization value setting, Automatic deceleration at power-off, AVR function, Automatic acceleration/deceleration, Auto tuning (Online/Offline), High torque multi-motor operation control (sensor-less vector control of two monitors with one inverter)		
				Analogue inputs	Analogue inputs 0 to 10 V and -10 to 10 V (10 K Ω), 4 to 20 mA (100 Ω)	
				Analogue outputs	Analogue voltage output, Analogue current output, Pulse train output	
				Accel/Decel times	0.01 to 3600.0 s (line/curve selection)	
				Display	Status indicator LED's Run, Program, Power, Alarm, Hz, Amps, Volts, %	
					Digital operator: Available to monitor 23 items, output current, output frequency...	
				Protection functions	Motor overload protection	Electronic Thermal overload relay and PTC thermistor input
					Instantaneous overcurrent	200% of rated current for 3 seconds
Overload	150% for 1 minute					
Overvoltage	800 V for 400 V type and 400 V for 200 V type					
Momentary power loss	Decelerates to stop with DC bus controlled, coast to stop					
Cooling fin overheat	Temperature monitor and error detection					
Stall prevention level	Stall prevention during acceleration, deceleration and constant speed					
Ground fault	Detection at power on					
Power charge indication	On when voltage between P and N is higher than 45 V					
Degree of protection	IP20/IP00					
Ambient conditions	Ambient humidity	90% RH or less (without condensation)				
	Storage temperature	-20°C to +65°C (short-term temperature during transportation)				
	Ambient temperature	-10°C to 50°C				
	Installation	Indoor (no corrosive gas, dust, etc.)				
	Installation height	Max. 1000 m				
Vibration	3G3RX-A□004 to A□220, 5.9 m/s ² (0.6G), 10 to 55 Hz					
	3G3RX-A□300 to B□13K, 2.94 m/s ² (0.3G), 10 to 55 Hz					

Dimensions

Figure 1

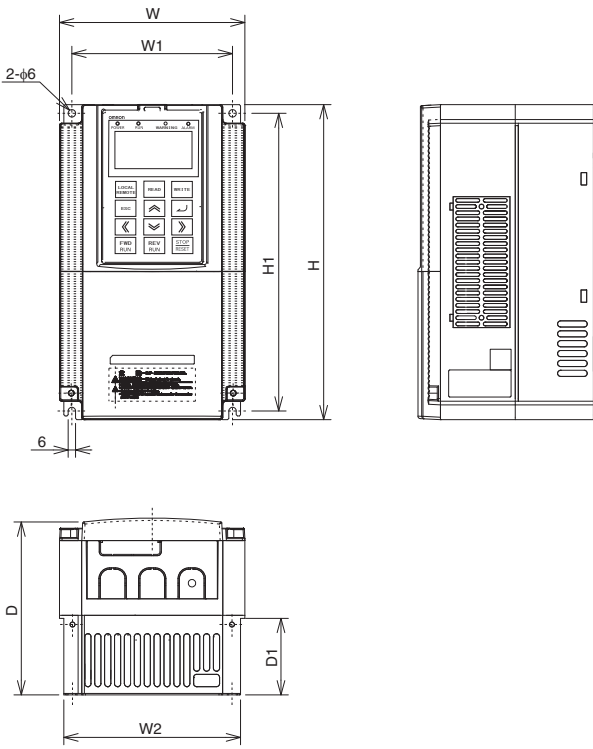

Figure 2

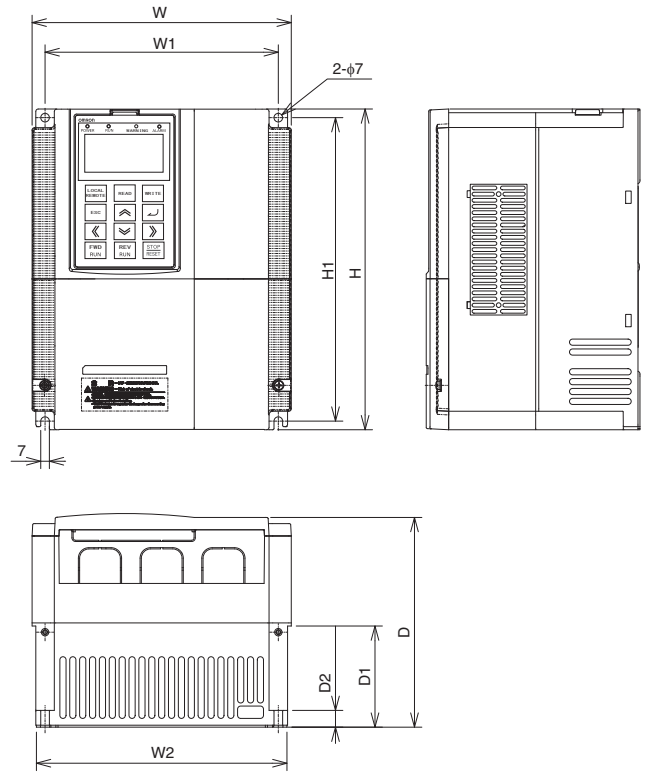

Figure 3

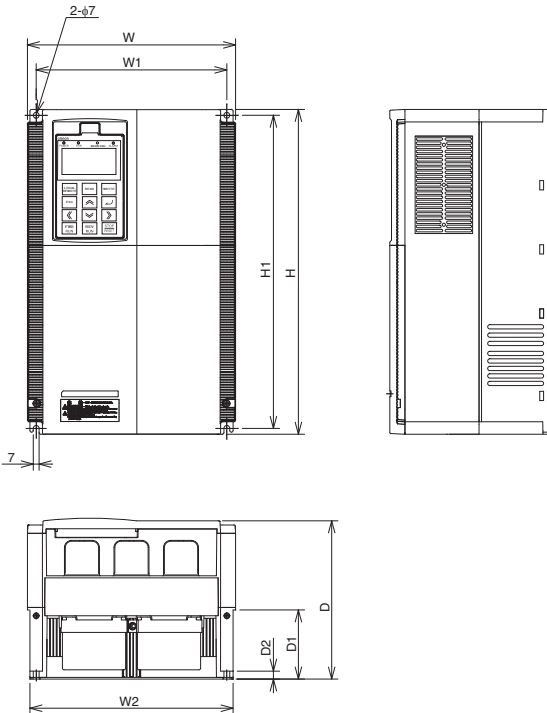

Figure 4

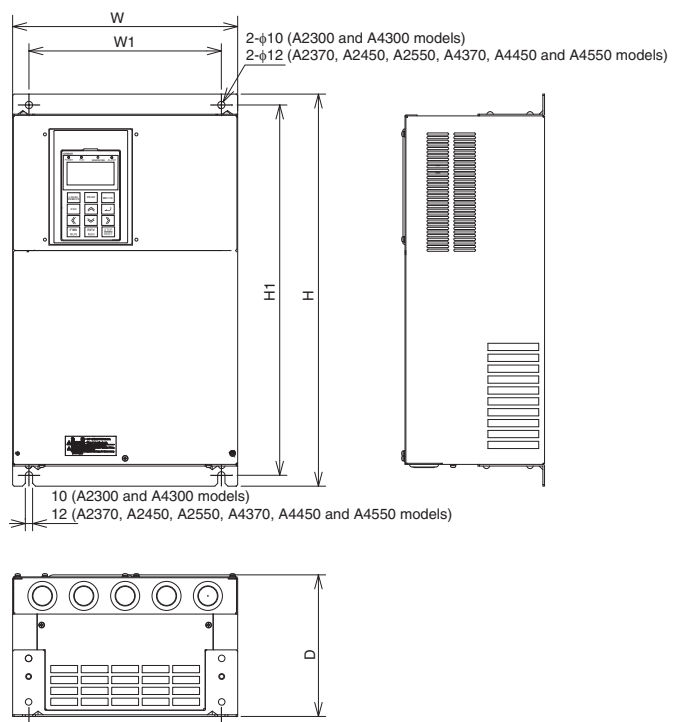
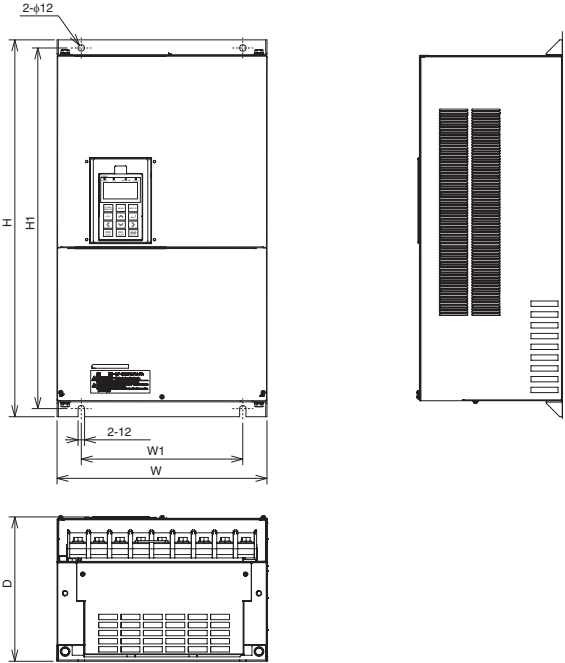

Figure 5



Voltage class	Inverter model 3G3RX□	Figure	Dimensions in mm								Weight (kg)
			W	W1	W2	H	H1	D	D1	D2	
Three-phase 200 V	A2004	1	150	130	143	255	241	140	62	-	3.5
	A2007										
	A2015										
	A2022										
	A2037										
	A2055	2	210	189	203	260	246	170	82	13.6	6
	A2075										
	A2110										
	A2150	3	250	229	244	390	376	190	83	9.5	14
	A2185										
	A2220										
	A2300	4	310	265	-	540	510	195	-	-	20
A2370	390		300	-	550	520	250	-	-	30	
A2450	480		380	-	700	670	250	-	-	43	
A2550											
Three-phase 400 V	A4004	1	150	130	143	255	241	140	62	-	3.5
	A4007										
	A4015										
	A4022										
	A4040										
	A4055	2	210	189	203	260	246	170	82	13.6	6
	A4075										
	A4110										
	A4150	3	250	229	244	390	376	190	83	9.5	14
	A4185										
	A4220										
	A4300	4	310	265	-	540	510	195	-	-	22
	A4370		390	300	-	550	520	250	-	-	30
	A4450		480	380	-	700	670	270	-	-	60
	A4550										
	B4750	5	390	300	-	740	710	270	-	-	80
	B4900										
	B411K										
B413K											

Rasmi filters

Footprint dimensions

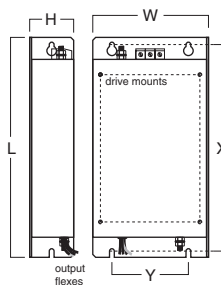

Book type dimensions

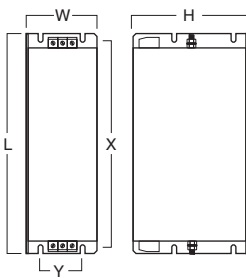

Block type dimensions

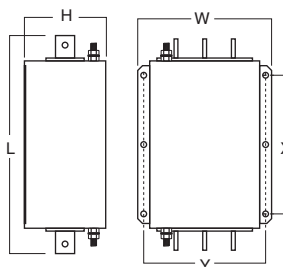

Voltage	Inverter model	Rasmi model	Dimensions						Filter type	Weight (kg)
			L	W	H	X	Y	M		
3x200 V	3G3RX-A2004	AX-FIR2018-RE	305	152	45	290	110	M5	Footprint	2.0
	3G3RX-A2007									
	3G3RX-A2015									
	3G3RX-A2022									
	3G3RX-A2037									
	3G3RX-A2055	AX-FIR2053-RE	320	212	56	296	189	M6	2.5	
	3G3RX-A2075									
	3G3RX-A2110									
	3G3RX-A2150	AX-FIR2110-RE	455	110	240	414	80	-	Book type	8.0
	3G3RX-A2185									
	3G3RX-A2220									
	3G3RX-A2300	AX-FIR2145-RE	386	260	135	240	235	-	Block type	13
	3G3RX-A2370	AX-FIR3250-RE								
3G3RX-A2450	AX-FIR3250-RE	386	260	135	240	235	-	Block type	13.2	
3G3RX-A2550	AX-FIR3320-RE									
3x400 V	3G3RX-A4004	AX-FIR3010-RE	305	152	45	290	110	M5	Footprint	1.4
	3G3RX-A4007									
	3G3RX-A4015									
	3G3RX-A4022									
	3G3RX-A4040									
	3G3RX-A4055	AX-FIR3030-RE	312	212	50	296	189	M6	2.2	
	3G3RX-A4075									
	3G3RX-A4110									
	3G3RX-A4150	AX-FIR3053-RE	451	252	60	435	229	M6	4.5	
	3G3RX-A4185									
	3G3RX-A4220									
	3G3RX-A4300	AX-FIR3064-RE	598	310	70	578	265	M8	7.0	
	3G3RX-A4370	AX-FIR3100-RE								
	3G3RX-A4450	AX-FIR3130-RE	486	110	240	414	80	-	Book type	8.6
	3G3RX-A4550									
	3G3RX-B4750									
	3G3RX-B4900	AX-FIR3250-RE	386	260	135	240	235	-	Block type	13.0
3G3RX-B411K	AX-FIR3320-RE									
3G3RX-B413K		13.2								

Input AC Reactor

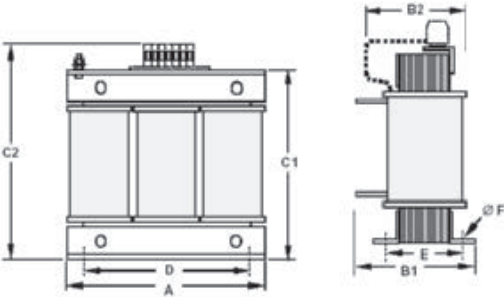

Voltage	Reference	Dimensions								Weight (kg)			
		A	B1	B2	C1	C2	D	E	F				
200 V	AX-RAI02800100-DE	120	-	80	-	120	80	62	5.5	2.35			
	AX-RAI00880200-DE			190		55							
	AX-RAI00350335-DE	180		205		140	75						
	AX-RAI00180670-DE			205				85					
	AX-RAI00091000-DE			105				85					
	AX-RAI00071550-DE			105				85					
AX-RAI00042300-DE	240	130	-	210	-	200	75	6	16.0				
400 V	AX-RAI07700050-DE	120	-	70	-	120	80	52	5.5	1.78			
	AX-RAI03500100-DE			80		62		2.35					
	AX-RAI01300170-DE			80		62		2.5					
	AX-RAI00740335-DE	180		85		140	75	55		6	5.5		
	AX-RAI00360500-DE			205				85			6.5		
	AX-RAI00290780-DE			105				85			11.7		
	AX-RAI00191150-DE			110				75			16.0		
	AX-RAI00111850-DE	240		165		-	210	-		200	110	6	27.0
	AX-RAI00072700-DE	110											

DC reactor

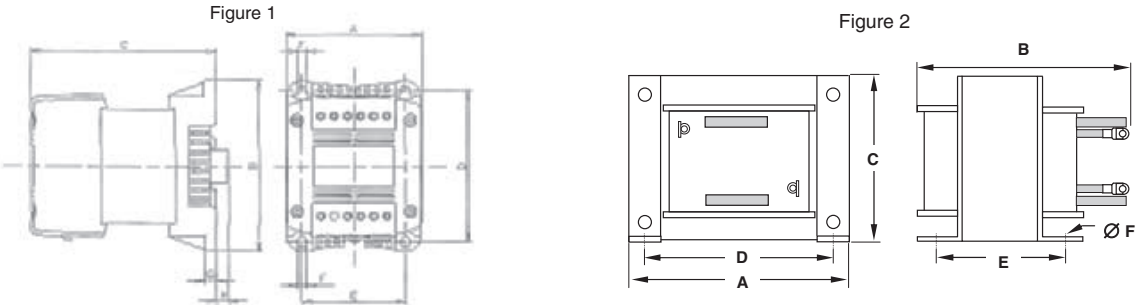

200 V											400 V																								
Reference AX-RC	Fig	Dimensions								kg	Reference AX-RC	Fig	Dimensions								kg														
		A	B	C	D	E	F	G	H				A	B	C	D	E	F	G	H															
10700032-DE	1	84	113	96	101	66	5	7.5	2	1.22	1	84	113	96	101	66	5	7.5	2	1.22															
06750061-DE				105						1.60				105						1.60															
03510093-DE				116						1.95				116						1.95															
02510138-DE		108	135	124	120	82	6.5	9.5	9.5	3.20		06400116-DE	108	135	133	120	82	6.5	9.5	9.5	3.70														
01600223-DE				136						5.20					136						5.20														
01110309-DE				146						6.00					146						6.00														
00840437-DE				160						11.4					160						11.4														
00590614-DE		150	177	160	160	115	7	2	-	14.3		01750430-DE	150	177	182.6	160	115	7	2	-	14.3														
00440859-DE				182.6						14.3					182.6						14.3														
00301275-DE				195						161					162.5						185	88	10	-	-	17.0	01200644-DE	195	161	162.5	185	88	10	-	-
00231662-DE	196	123	25.5	00920797-DE	196	123	25.5																												
00192015-DE	188	109	34.0	00741042-DE	188	109	34.0																												
00162500-DE	240	198	200	228	119	12	-	-	38.0	00611236-DE	240	198	200	228	119	12	-	-	38.0																
00133057-DE									228										149	42.0	00501529-DE	228	149			42.0									
										00372094-DE	300	216	250	288	133	153	-	-	48.0																
										00312446-DE									67.0																
										00252981-DE									67.0																
										00213613-DE									79.0																

Output AC reactor

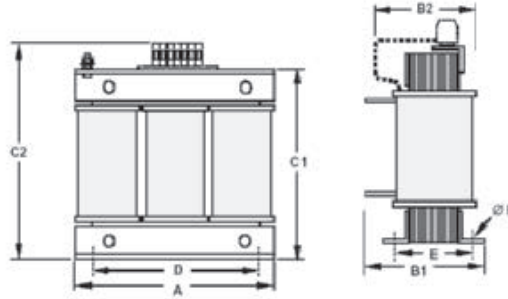

Reference	Dimensions								Weight kg
	A	B1	B2	C1	C2	D	E	F	
AX-RAO11500026-DE	120	-	70	-	120	80	52	5.5	1.78
AX-RAO07600042-DE	120	-	70	-	120	80	52	5.5	1.78
AX-RAO04100075-DE	120	-	80	-	120	80	62	5.5	2.35
AX-RAO03000105-DE	120	-	80	-	120	80	62	5.5	2.35
AX-RAO01830160-DE	180	-	85	-	190	140	55	6	5.5
AX-RAO01150220-DE	180	-	85	-	190	140	55	6	5.5
AX-RAO00950320-DE	180	-	85	-	205	140	55	6	6.5
AX-RAO00630430-DE	180	-	95	-	205	140	65	6	9.1
AX-RAO00490640-DE	180	-	95	-	205	140	65	6	9.1
AX-RAO00390800-DE	240	-	110	-	275	200	75	6	16.0
AX-RAO00330950-DE	240	-	110	-	275	200	75	6	16.0
AX-RAO00251210-DE	240	-	110	-	275	200	75	6	16.0
AX-RAO00191450-DE	240	-	120	-	275	200	85	6	18.6
AX-RAO00161820-DE	240	-	150	-	275	200	110	6	27.0
AX-RAO00132200-DE	240	165	-	210	-	200	110	6	27.0
AX-RAO16300038-DE	120	-	70	-	120	80	52	5.5	1.78
AX-RAO11800053-DE	120	-	80	-	120	80	52	5.5	2.35
AX-RAO07300080-DE	120	-	80	-	120	80	62	5.5	2.35
AX-RAO04600110-DE	180	-	85	-	190	140	55	6	5.5
AX-RAO03600160-DE	180	-	85	-	205	140	55	6	6.5
AX-RAO02500220-DE	180	-	95	-	205	140	55	6	9.1
AX-RAO02000320-DE	180	-	105	-	205	140	85	6	11.7
AX-RAO01650400-DE	240	-	110	-	275	200	75	6	16.0
AX-RAO01300480-DE	240	-	120	-	275	200	85	6	18.6
AX-RAO01030580-DE	240	-	120	-	275	200	85	6	18.6
AX-RAO00800750-DE	240	-	120	-	275	200	110	6	27.0
AX-RAO00680900-DE	240	-	150	-	275	200	110	6	27.0
AX-RAO00531100-DE	240	-	150	-	275	200	110	6	27.0
AX-RAO00401490-DE	300	-	165	-	320	200	125	6	44.0
AX-RAO00331760-DE	300	-	165	-	320	200	125	6	44.0
AX-RAO00262170-DE	360	230	-	300	-	300	145	8	70.0
AX-RAO00212600-DE	360	230	-	300	-	300	145	8	70.0

Chokes

Reference	D diameter	Motor KW	Dimensions						Weight kg
			L	W	H	X	Y	m	
AX-FER2102-RE	21	< 2.2	85	22	46	70	-	5	0.1
AX-FER2515-RE	25	< 15	105	25	62	90	-	5	0.2
AX-FER5045-RE	50	< 45	150	50	110	125	30	5	0.7
AX-FER6055-RE	60	< 55	200	65	170	180	45	6	1.7

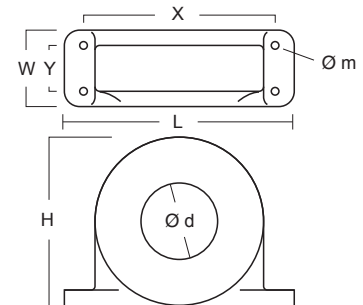

Braking unit dimensions

Reference	Dimensions					
	B	B1	H	H1	T	S
AX-BCR4015045-TE	82.5	40.5	150	138	220	6
AX-BCR4017068-TE						
AX-BCR2035090-TE	130	64.5	205	193	208	6
AX-BCR2070130-TE						
AX-BCR4035090-TE						
AX-BCR4070130-TE						
AX-BCR4090240-TE	131	64.5	298	280	300	9

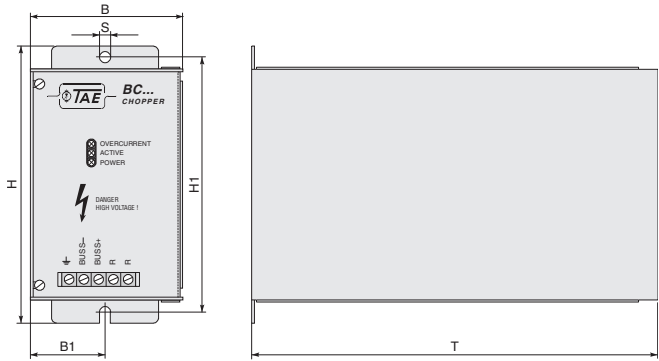

Resistor dimensions

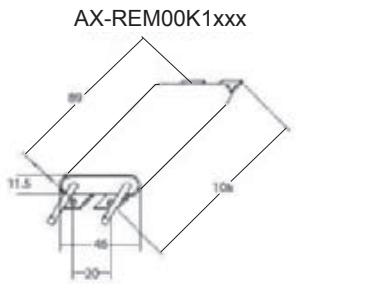

Fig 3

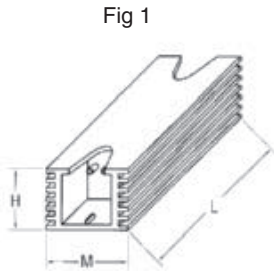

Fig 4

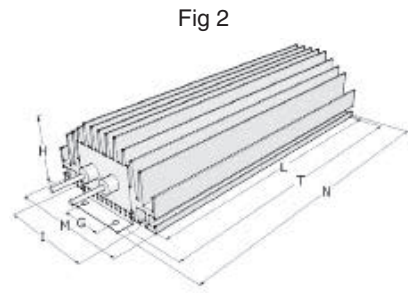
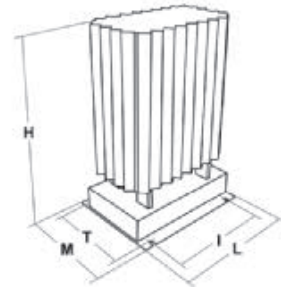
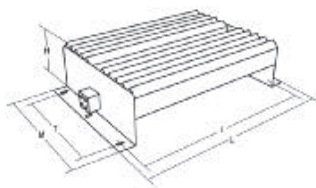
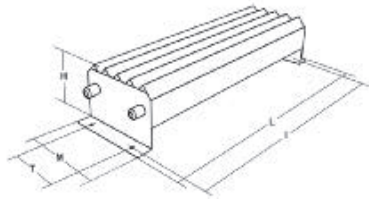
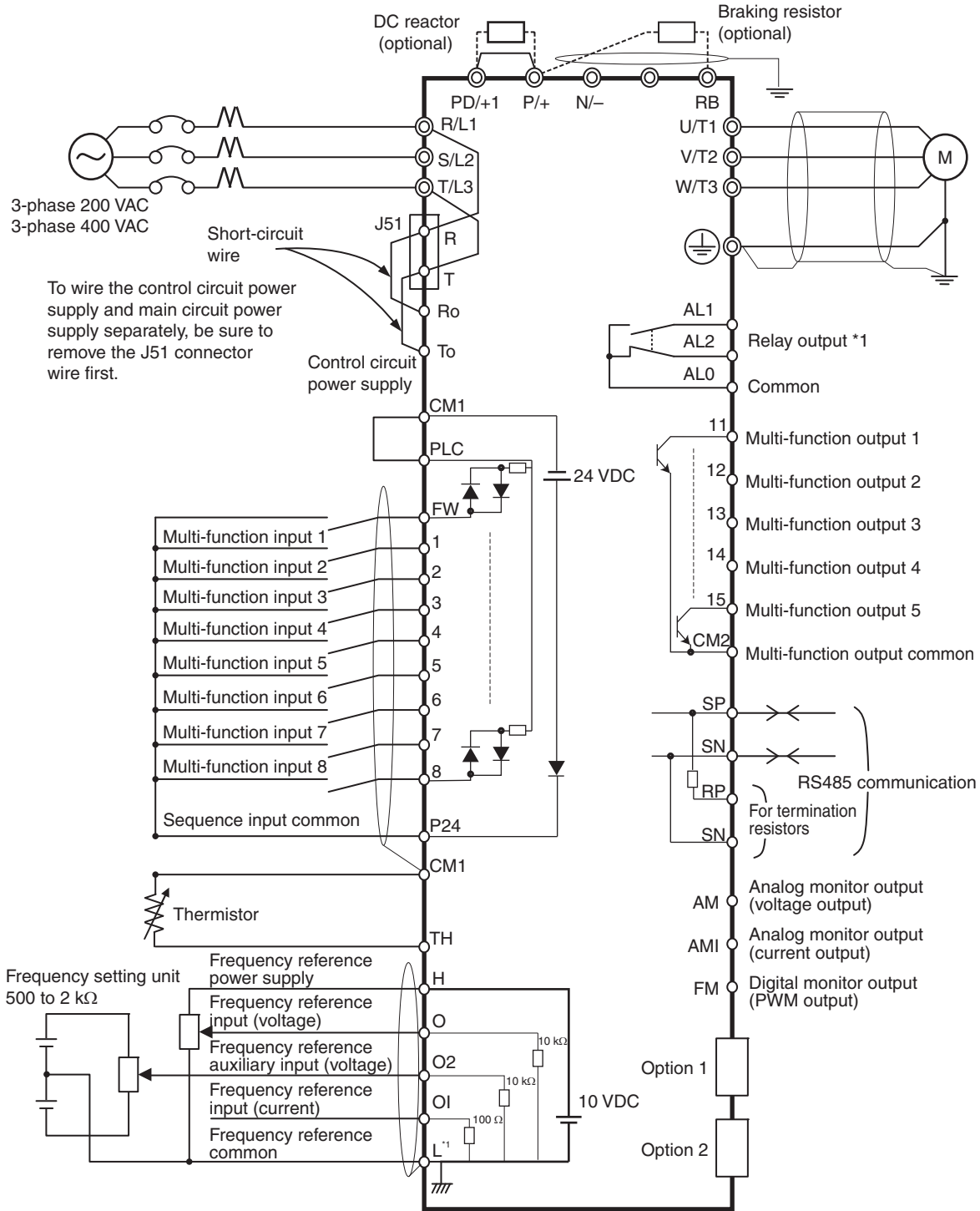

Fig 5



Type	Fig.	Dimensions							Weight kg
		L	H	M	I	T	G	N	
AX-REM00K2070-IE	1	105	27	36	94	-	-	-	0.2
AX-REM00K2120-IE									
AX-REM00K2200-IE									
AX-REM00K4075-IE									
AX-REM00K4035-IE									
AX-REM00K4030-IE									
AX-REM00K5120-IE									
AX-REM00K6100-IE	2	200	61	100	74	211	40	230	1.41
AX-REM00K9020-IE									
AX-REM00K9017-IE									
AX-REM01K9070-IE	3	365	73	105	350	70	-	-	4
AX-REM01K9017-IE									
AX-REM02K1070-IE	4	310	100	240	295	210	-	-	7
AX-REM02K1017-IE									
AX-REM03K5035-IE									
AX-REM03K5010-IE	5	206	350	140	190	50	-	-	8.1
AX-REM19K0006-IE									
AX-REM19K0008-IE									
AX-REM19K0020-IE									
AX-REM19K0030-IE									
AX-REM38K0012-IE	306	350	140	290	50	-	-	14.5	

Standard connections



*1 L is the common reference for analog input and also for analog output.

Terminal block specifications

Terminal	Name	Function (signal level)
R/L1, S/L2, T/L3	Main circuit power supply input	Used to connect line power to the drive.
U/T1, V/T2, W/T3	Inverter output	Used to connect the motor
PD/+1, P/+	External DC reactor terminal	Normally connected by the short-circuit bar. Remove the short-circuit bar between +1 and P/+2 when a DC reactor is connected.
P/+, RB	Braking resistor connection terminals	Connect option braking resistor (if a braking torque is required)
P/+, N/-	Regenerative braking unit connection terminal	Connect optional regenerative braking units.
⊕	Grounding	For grounding (grounding should conform to the local grounding code.)

Control circuit

Type	No.	Signal name	Function	Signal level
Frequency reference input	H	Frequency reference power supply	10 VDC 20 mA max	
	O	Voltage frequency reference input	0 to 12 VDC (10 kΩ)	
	O2	Voltage auxiliary frequency reference	0 to ±12 VDC (10 kΩ)	
	OI	Current frequency reference input	4 to 20 mA (100 Ω)	
	L	Frequency reference common	Common terminal for analog monitor (AM, AMI) terminals	
Monitor Output	AM	Multi-function analog voltage output	Factory setting: Output frequency	2 mA max
	AMI	Multi-function analog current output	Factory setting: Output frequency	4 to 20 mA (max imp 250 Ω)
	FM	PWM monitor output	Factory setting: Output frequency	0 to 10 VDC Max 3.6 kHz
Power Supply	P24	Internal 24 VDC	Power supply for contact input signal	100 mA max
	CM1	Input common	Common terminal for P24, TH and FM digital monitor	
Function selection	FW	Forward rotation command terminal	Motor runs in forwards direction when FW is ON	
	1	Multi-function input	Factory setting: Reverse (RV)	27 VDC max Input impd 4.7 kΩ Max current 5.6 mA On: 18 VDC or more
	2		Factory setting: External trip (EXT)	
	3		Factory setting: Reset (RS)	
	4		Factory setting: Multi-step speed reference 1 (CF1)	
	5		Factory setting: Multi-step speed reference 2 (CF2)	
	6		Factory setting: Jogging (JG)	
	7		Factory setting: Second control (SET)	
	8		Factory setting: No allocation (NO)	
PLC	Multi-function input common	Sink logic: Short-circuiting P24 and PLC Source logic: Short-circuiting PLC and CM1 With external supply remove short-circuit bar		
Status/Factor	11	Multi-function output	Factory setting: During Run (RUN)	27 VDC max 50 mA max
	12		Factory setting: 0 Hz signal (ZS)	
	13		Factory setting: Overload warning (OL)	
	14		Factory setting: Overtorque (OTQ)	
	15		Factory setting: Constant speed arrival (FA1)	
	CM2	Multi-function output common	Common terminal for multi-function output terminals 11 to 15	
Relay output	AL1	Relay output (Normally close)	Factory setting: Alarm output (AL) Under normal operation MA-MC open MB-MC close	R load AL1-AL0 250 VAC 2 A AL2-AL0 250 VAC 1 A I load 250 VAC 0.2 A
	AL2	Relay output (Normally open)		
	AL0	Relay output common		
Sensor	TH	External thermistor input terminal	SC terminal functions as the common terminal 100 mW minimum Impedance at temperature error: 3 kΩ	0 to 8 VDC
Comms	SP	RS485 Modbus terminals	-	Differential input
	SN			
	RP	RS485 terminating resistor terminals	-	-
	SN			

Inverter heat loss

Three-phase 200 V class

Model 3G3RX-		A2004	A2007	A2015	A2022	A2037	A2055	A2075	A2110	A2150	A2185	A2220	A2300	A2370	A2450	A2550
Inverter capacity kVA	200 V	1.0	1.7	2.5	3.6	5.7	8.3	11.0	15.9	22.1	26.3	32.9	41.9	50.2	63.0	76.2
	240 V	1.2	2.0	3.1	4.3	6.8	9.9	13.3	19.1	26.6	31.5	39.4	50.2	60.2	75.6	91.4
Rated current (A)		3.0	5.0	7.5	10.5	16.5	24	32	46	64	76	95	121	145	182	220
Heat loss W	Losses at 70% load	64	76	102	127	179	242	312	435	575	698	820	1100	1345	1625	1975
	Losses at 100% load	70	88	125	160	235	325	425	600	800	975	1150	1550	1900	2300	2800
Efficiency at rated output		85.1	89.5	92.3	93.2	94.0	94.4	94.6	94.8	94.9	95.0	95.0	95.0	95.1	95.1	95.1
Cooling Method		Forced-air-cooling														

Three-phase 400 V class

Model 3G3RX-		A4004	A4007	A4015	A4022	A4040	A4055	A4075	A4110	A4150	A4185	A4220	A4300	A4370	A4450	A4550	B4750	B4900	B411K	B413K
Inverter capacity kVA	400 V	1.0	1.7	2.5	3.6	6.2	9.7	13.1	17.3	22.1	26.3	33.2	40.1	51.9	63.0	77.6	103.2	121.9	150.3	180.1
	480 V	1.2	2.0	3.1	4.3	7.4	11.6	15.8	20.7	26.6	31.5	39.9	48.2	62.3	75.6	93.1	123.8	146.3	180.4	216.1
Rated current (A)		1.5	2.5	3.8	5.3	9.0	14	19	25	32	38	48	58	75	91	112	149	176	217	260
Heat loss W	Losses at 70% load	64	76	102	127	179	242	312	435	575	698	820	1100	1345	1625	1975	2675	3375	3900	4670
	Losses at 100% load	70	88	125	160	235	325	425	600	800	975	1150	1550	1900	2300	2800	3800	4800	5550	6650
Efficiency at rated output		85.1	89.5	92.3	93.2	94.0	64.4	94.6	94.8	94.9	95.0	95.0	95.0	95.1	95.1	95.1	95.2	95.2	95.2	95.2
Cooling Method		Forced-air-cooling																		

Input AC Reactor

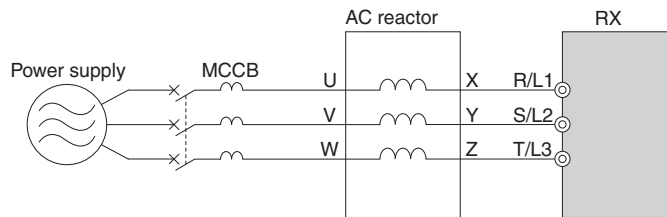

3 phase 200 V class				400 V class			
Max. applicable motor output kW	Reference	Current value A	Inductance mH	Max. applicable motor output kW	Reference	Current value A	Inductance mH
0.4 to 1.5	AX-RAI02800100-DE	10.0	2.8	0.4 to 1.5	AX-RAI07700050-DE	5.0	7.7
2.2 to 3.7	AX-RAI00880200-DE	20.0	0.88	2.2 to 3.7	AX-RAI03500100-DE	10.0	3.5
5.5 to 7.5	AX-RAI00350335-DE	33.5	0.35	5.5 to 7.5	AX-RAI01300170-DE	17.0	1.3
11.0 to 15.0	AX-RAI00180670-DE	67.0	0.18	11.0 to 15.0	AX-RAI00740335-DE	33.5	0.74
18.5 to 22.0	AX-RAI00091000-DE	100.0	0.09	18.5 to 22.0	AX-RAI00360500-DE	50.0	0.36
30.0 to 37.0	AX-RAI00071550-DE	155.0	0.07	30.0 to 37.0	AX-RAI00290780-DE	78.0	0.29
45.0 to 55.0	AX-RAI00042300-DE	230.0	0.04	45.0 to 55.0	AX-RAI00191150-DE	115.0	0.19
				75.0 to 90.0	AX-RAI00111850-DE	185.0	0.11
				110.0 to 132.0	AX-RAI00072700-DE	270.0	0.07

DC Reactor

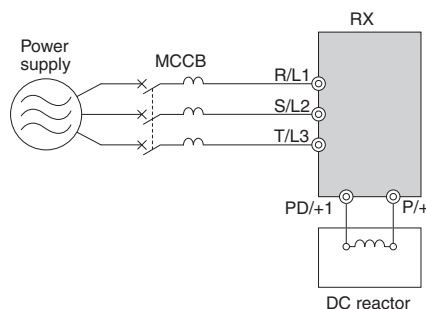

200 V class				400 V class			
Max. applicable motor output kW	Reference	Current value A	Inductance mH	Max. applicable motor output kW	Reference	Current value A	Inductance mH
0.4	AX-RC10700032-DE	3.2	10.70	0.4	AX-RC43000020-DE	2.0	43.00
0.7	AX-RC06750061-DE	6.1	6.75	0.7	AX-RC27000030-DE	3.0	27.00
1.5	AX-RC03510093-DE	9.3	3.51	1.5	AX-RC14000047-DE	4.7	14.00
2.2	AX-RC02510138-DE	13.8	2.51	2.2	AX-RC10100069-DE	6.9	10.10
3.7	AX-RC01600223-DE	22.3	1.60	4.0	AX-RC06400116-DE	11.6	6.40
5.5	AX-RC01110309-DE	30.9	1.11	5.5	AX-RC04410167-DE	16.7	4.41
7.5	AX-RC00840437-DE	43.7	0.84	7.5	AX-RC03350219-DE	21.9	3.35
11.0	AX-RC00590614-DE	61.4	0.59	11.0	AX-RC02330307-DE	30.7	2.33
15.0	AX-RC00440859-DE	85.9	0.44	15.0	AX-RC01750430-DE	43.0	1.75
18.5 to 22	AX-RC00301275-DE	127.5	0.30	18.5 to 22	AX-RC01200644-DE	64.4	1.20
30	AX-RC00231662-DE	166.2	0.23	30	AX-RC00920797-DE	79.7	0.92
37	AX-RC00192015-DE	201.5	0.19	37	AX-RC00741042-DE	104.2	0.74
45	AX-RC00162500-DE	250.0	0.16	45	AX-RC00611236-DE	123.6	0.61
55	AX-RC00133057-DE	305.7	0.13	55	AX-RC00501529-DE	152.9	0.50
				75	AX-RC00372094-DE	209.4	0.37
				90	AX-RC00312446-DE	244.6	0.31
				110	AX-RC00252981-DE	298.1	0.25
				132	AX-RC00213613-DE	361.3	0.21

Output AC Reactor

200 V class				400 V class			
Max. applicable motor output kW*	Reference	Current value A	Inductance mH	Max. applicable motor output kW* ¹	Reference	Current value A	Inductance mH
0.4	AX-RAO11500026-DE	2.6	11.50	0.4 to 1.5	AX-RAO16300038-DE	3.8	16.30
0.75	AX-RAO07600042-DE	4.2	7.60				
1.5	AX-RAO04100075-DE	7.5	4.10				
2.2	AX-RAO03000105-DE	10.5	3.00	2.2	AX-RAO11800053-DE	5.3	11.80
3.7	AX-RAO01830160-DE	16.0	1.83	4.0	AX-RAO07300080-DE	8.0	7.30
5.5	AX-RAO01150220-DE	22.0	1.15	5.5	AX-RAO04600110-DE	11.0	4.60
7.5	AX-RAO00950320-DE	32.0	0.95	7.5	AX-RAO03600160-DE	16.0	3.60
11	AX-RAO00630430-DE	43.0	0.63	11	AX-RAO02500220-DE	22.0	2.50
15	AX-RAO00490640-DE	64.0	0.49	15	AX-RAO02000320-DE	32.0	2.00
18.5	AX-RAO00390800-DE	80.0	0.39	18.5	AX-RAO01650400-DE	40.0	1.65
22	AX-RAO00330950-DE	95.0	0.33	22	AX-RAO01300480-DE	48.0	1.30
30	AX-RAO00251210-DE	121.0	0.25	30	AX-RAO01030580-DE	58.0	1.03
37	AX-RAO00191450-DE	145.0	0.19	37	AX-RAO00800750-DE	75.0	0.80
45	AX-RAO00161820-DE	182.0	0.16	45	AX-RAO00680900-DE	90.0	0.68
55	AX-RAO00132200-DE	220.0	0.13	55	AX-RAO00531100-DE	110.0	0.53
				75	AX-RAO00401490-DE	149.0	0.40
				90	AX-RAO00331760-DE	176.0	0.33
				110	AX-RAO00262170-DE	217.0	0.26
				132	AX-RAO00212600-DE	260.0	0.21

*1 These motor sizes are for heavy duty applications.

Braking Unit

Voltage	Reference	Specifications				
		Permanent		Peak (5 s max)		Minimum connectable resistor (Ohms)
		Current (A)	Brake power (kVA)	Current (A)	Brake power (kVA)	
200 V	AX-BCR2035090-TE	35	13	90	32	4
	AX-BCR2070130-TE	70	25	130	47	2.8
400 V	AX-BCR4015045-TE	15	11	45	33	16
	AX-BCR4017068-TE	17	13	68	51	11
	AX-BCR4035090-TE	35	26	90	67	8.5
	AX-BCR4070130-TE	70	52	130	97	5.5
	AX-BCR4090240-TE	90	67	240	180	3.2

Ordering information

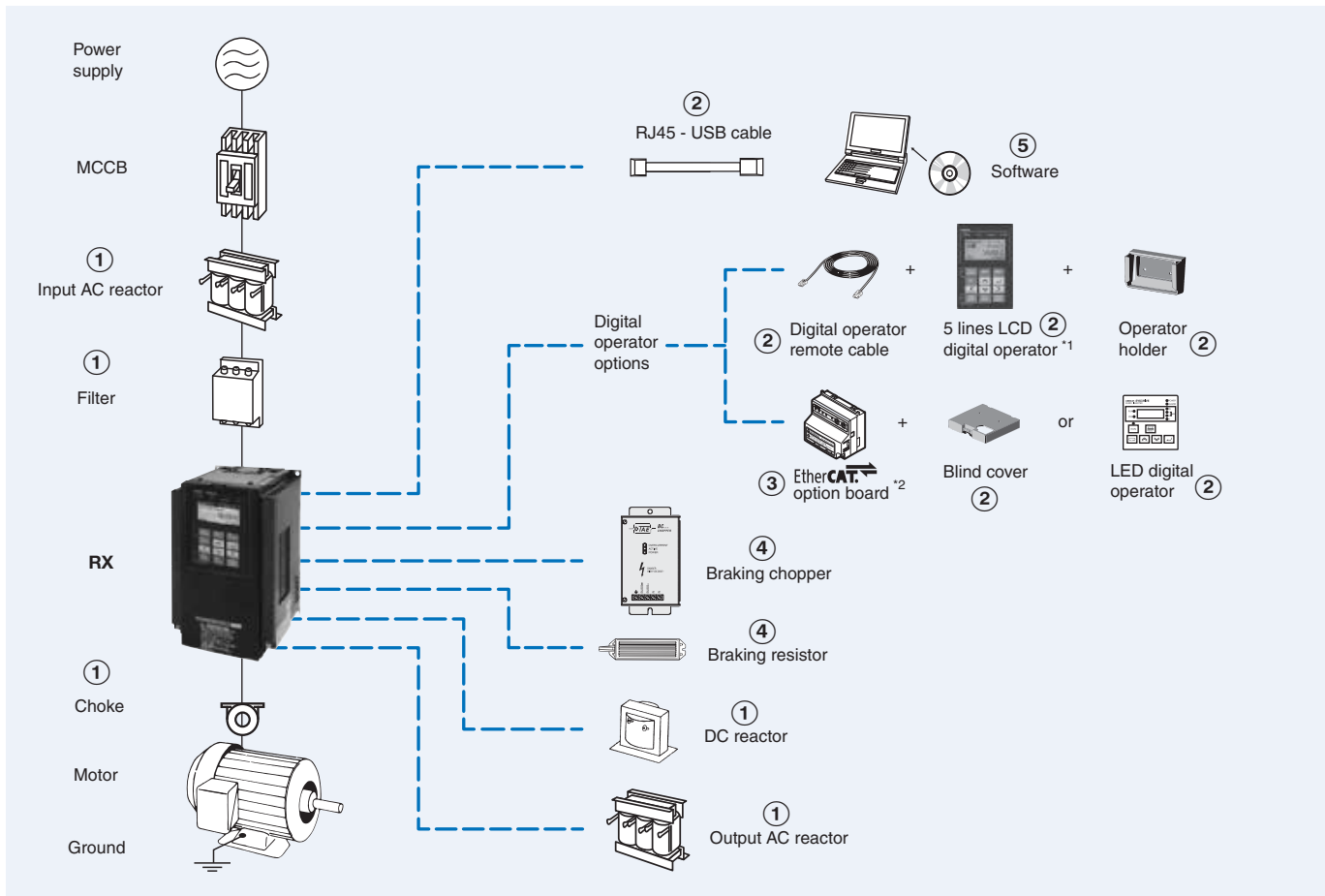

¹ The 5 lines LCD digital operator is provided with the inverter from factory.

² When a communication option board is mounted, there are two options: mount a blind cover or a LED digital operator.

3G3RX

Specifications					Model	Specifications					Model
Voltage class	Constant torque		Variable torque		Standard	Voltage class	Constant torque		Variable torque		Standard
	Max motor kW	Rated current A	Max motor kW	Rated current A			Max motor kW	Rated current A	Max motor kW	Rated current A	
Three-phase 200 V	0.4	3.0	0.75	3.7	3G3RX-A2004-E1F	Three-phase 400 V	0.4	1.5	0.75	1.9	3G3RX-A4004-E1F
	0.75	5.0	1.5	6.3	3G3RX-A2007-E1F		0.75	2.5	1.5	3.1	3G3RX-A4007-E1F
	1.5	7.5	2.2	9.4	3G3RX-A2015-E1F		1.5	3.8	2.2	4.8	3G3RX-A4015-E1F
	2.2	10.5	4.0	12	3G3RX-A2022-E1F		2.2	5.3	4.0	6.7	3G3RX-A4022-E1F
	4.0	16.5	5.5	19.6	3G3RX-A2037-E1F		4.0	9.0	5.5	11.1	3G3RX-A4040-E1F
	5.5	24	7.5	30	3G3RX-A2055-E1F		5.5	14	7.5	16	3G3RX-A4055-E1F
	7.5	32	11	44	3G3RX-A2075-E1F		7.5	19	11	22	3G3RX-A4075-E1F
	11	46	15	58	3G3RX-A2110-E1F		11	25	15	29	3G3RX-A4110-E1F
	15	64	18.5	73	3G3RX-A2150-E1F		15	32	18.5	37	3G3RX-A4150-E1F
	18.5	76	22	85	3G3RX-A2185-E1F		18.5	38	22	43	3G3RX-A4185-E1F
	22	95	30	113	3G3RX-A2220-E1F		22	48	30	57	3G3RX-A4220-E1F
	30	121	37	140	3G3RX-A2300-E1F		30	58	37	70	3G3RX-A4300-E1F
	37	145	45	169	3G3RX-A2370-E1F		37	75	45	85	3G3RX-A4370-E1F
	45	182	55	210	3G3RX-A2450-E1F		45	91	55	105	3G3RX-A4450-E1F
55	220	75	270	3G3RX-A2550-E1F	55	112	75	135	3G3RX-A4550-E1F		
					75	149	90	160	3G3RX-B4750-E1F		
					90	176	110	195	3G3RX-B4900-E1F		
					110	217	132	230	3G3RX-B411K-E1F		
					132	260	160	290	3G3RX-B413K-E1F		

① Line filters

Rasmi Line filter									
200V					400V				
Model 3G3RX-□	Reference	Rated current (A)	Leakage Nom/max	kg	Model 3G3RX-□	Reference	Rated current (A)	Leakage Nom/max	kg
A2004/A2007/A2015/A2022/A2037	AX-FIR2018-RE	18	0.7/40 mA	2.0	A4004/A4007/A4015/A4022/A4040	AX-FIR3010-RE	10	0.3/40 mA	1.9
A2055/A2075/A2110	AX-FIR2053-RE	53	0.7/40 mA	2.5	A4055/A4075/A4110	AX-FIR3030-RE	30	0.3/40 mA	2.2
A2150/A2185/A2220	AX-FIR2110-RE	110	1.2/70 mA	8.0	A4150/A4185/A4220	AX-FIR3053-RE	53	0.8/70 mA	4.5
A2300	AX-FIR2145-RE	145	1.2/70 mA	8.6	A4300	AX-FIR3064-RE	64	3/160 mA	7.0
A2370/A2450	AX-FIR3250-RE	250	6/300 mA	13.0	A4370	AX-FIR3100-RE	100	2/130 mA	8.0
A2550	AX-FIR3320-RE	320	6/300 mA	13.2	A4450/A4550	AX-FIR3130-RE	130	2/130 mA	8.6
					A4750/A4900	AX-FIR3250-RE	250	10/500 mA	13.0
					A411K/A413K	AX-FIR3320-RE	320	10/500 mA	13.2

① Input AC Reactors

Voltage			
3-phase 200 VAC		3-phase 400 VAC	
Inverter Model 3G3RX-□	AC Reactor Reference	Inverter Model 3G3RX-□	AC Reactor Reference
A2004/A2007/A2015	AX-RAI02800100-DE	A4004/A4007/A4015	AX-RAI07700050-DE
A2022/A2037	AX-RAI00880200-DE	A4022/A4040	AX-RAI03500100-DE
A2055/A2075	AX-RAI00350335-DE	A4055/A4075	AX-RAI01300170-DE
A2110/A2150	AX-RAI00180670-DE	A4110/A4150	AX-RAI00740335-DE
A2185/A2220	AX-RAI00091000-DE	A4185/A4220	AX-RAI00360500-DE
A2300/A2370	AX-RAI00071550-DE	A4300/A4370	AX-RAI00290780-DE
A2450/A2550	AX-RAI00042300-DE	A4450/A4550	AX-RAI00191150-DE
		A4750/A4900	AX-RAI00111850-DE
		A411K/A413K	AX-RAI00072700-DE

① DC Reactors

Voltage			
3-phase 200 VAC		3-phase 400 VAC	
Inverter Model 3G3RX-□	AC Reactor Reference	Inverter Model 3G3RX-□	AC Reactor Reference
A2004	AX-RC10700032-DE	A4004	AX-RC43000020-DE
A2007	AX-RC06750061-DE	A4007	AX-RC27000030-DE
A2015	AX-RC03510093-DE	A4015	AX-RC14000047-DE
A2022	AX-RC02510138-DE	A4022	AX-RC10100069-DE
A2037	AX-RC01600223-DE	A4040	AX-RC06400116-DE
A2055	AX-RC01110309-DE	A4055	AX-RC04410167-DE
A2075	AX-RC00840437-DE	A4075	AX-RC03350219-DE
A2110	AX-RC00590614-DE	A4110	AX-RC02330307-DE
A2150	AX-RC00440859-DE	A4150	AX-RC01750430-DE
A2185/A2220	AX-RC00301275-DE	A4185/A4220	AX-RC01200644-DE
A2300	AX-RC00231662-DE	A4300	AX-RC00920797-DE
A2370	AX-RC00192015-DE	A4370	AX-RC00741042-DE
A2450	AX-RC00162500-DE	A4450	AX-RC00611236-DE
A2550	AX-RC00133057-DE	A4550	AX-RC00501529-DE
		A4750	AX-RC00372094-DE
		A4900	AX-RC00312446-DE
		A411K	AX-RC00252981-DE
		A413K	AX-RC00213613-DE

① Chokes

Model	Diameter	Description
AX-FER2102-RE	21	For 2.2 kW motors or below
AX-FER2515-RE	25	For 15 kW motors or below
AX-FER5045-RE	50	For 45 kW motors or below
AX-FER6055-RE	60	For 55 kW motors or above





① Output AC Reactor

Voltage			
200V		400V	
Model 3G3RX-□	Reference	Model 3G3RX-□	Reference
A2004	AX-RAO11500026-DE	A4004/A4007/A4015	AX-RAO16300038-DE
A2007	AX-RAO07600042-DE		
A2015	AX-RAO04100075-DE		
A2022	AX-RAO03000105-DE	A4022	AX-RAO11800053-DE
A2037	AX-RAO01830160-DE	A4040	AX-RAO07300080-DE
A2055	AX-RAO01150220-DE	A4055	AX-RAO04600110-DE

Voltage			
200V		400V	
Model 3G3RX-□	Reference	Model 3G3RX-□	Reference
A2075	AX-RAO00950320-DE	A4075	AX-RAO03600160-DE
A2110	AX-RAO00630430-DE	A4110	AX-RAO02500220-DE
A2150	AX-RAO00490640-DE	A4150	AX-RAO02000320-DE
A2185	AX-RAO00390800-DE	A4185	AX-RAO01650400-DE
A2220	AX-RAO00330950-DE	A4220	AX-RAO01300480-DE
A2300	AX-RAO00251210-DE	A4300	AX-RAO01030580-DE
A2370	AX-RAO00191450-DE	A4370	AX-RAO00800750-DE
A2450	AX-RAO00161820-DE	A4450	AX-RAO00680900-DE
A2550	AX-RAO00132200-DE	A4550	AX-RAO00531100-DE
		A4750	AX-RAO00401490-DE
		A4900	AX-RAO00331760-DE
		A411K	AX-RAO00262170-DE
		A413K	AX-RAO00212600-DE

Note: This table corresponds with HD rating. When ND is used, please choose the reactor for the next size inverter.

② Accessories

Types	Appearance	Model	Description
Remote digital operator		3G3AX-OP05	5 Line LCD digital operator with copy function ^{*1}
		3G3AX-OP05-H-E	Operator holder (for inside cabinet mounting)
		3G3AX-OP01	LED remote digital operator
		4X-KITmini	Mounting kit
LED digital operator		3G3AX-OP03	To be used in combination with communication option boards
Blind cover		3G3AX-OP05-B-E	
Cables		3G3AX-CAJOP300-EE	3 m remote digital operator cable
		USB-CONVERTERCABLE	RJ45 to USB connection cable
		3G3AX-PCACN2	

*1 This digital operator is provided with the RX inverter from factory.

③ Option boards

Types	Model	Description	Functions
Encoder Feedback	3G3AX-PG	PG speed controller option card	Phase A,B and Z pulse (differential pulse) inputs (RS-422) Pulse train position command input (RS-422) Pulse monitor output (RS-422) PG frequency range: 100 kHz max
Communication option board	3G3AX-RX-ECT	EtherCAT option card	Used for running or stopping the inverter, setting or referencing parameters, and monitoring output frequency, output current... through communications with the host controller.

④ Braking unit, braking resistor unit

Inverter					Braking resistor unit							
Voltage	Max. motor kW	Inverter 3G3RX□ 3-phase	Braking Unit AX-BCR□	Connectable min. resistance Ω	Inverter mounted type (3%ED, 10 sec max)		Braking torque %	External resistor 10%ED 10 sec max for built-in 5 sec max for Braking Unit		Braking torque %		
					Type AX-	Resist Ω		Type AX-	Resist Ω			
200 V (single-/three-phase)	0.55	2004	Built-in	50	REM00K1200-IE	200	180	REM00K1200-IE	200	180		
	1.1	2007					100	REM00K2070-IE	70	200		
	1.5	2015			35	140	REM00K4075-IE	75	130			
	2.2	2022				90	REM00K4035-IE	35	180			
	4.0	2037		16	REM00K4075-IE	75	50	REM00K6035-IE	35	100		
	5.5	2055					75	REM00K9020-IE	20	150		
	7.5	2075		10	REM00K4035-IE	35	55	REM01K9017-IE	17	110		
	11.0	2110					40	REM02K1017-IE	17	75		
	15.0	2150		7.5	REM00K9017-IE	17	55	REM03K5010-IE	10	95		
	18.5	2185					75	REM03K5010-IE	10	75	REM19K0008-IE	8
	22.0	2220		5	65	80						
	30.0	2300		2035090-TE	4	-				REM19K0006-IE	6	80
	37.0	2370								6	60	
	45.0	2450		2070130-TE	2.8	-				2 × REM19K0006-IE	3	105
55.0	2550	3	85									
400 V (three-phase)	0.55	4004	Built-in	100	REM00K1400-IE	400	200	REM00K1400-IE	400	200		
	1.1	4007					200			190	REM00K2200-IE	200
	1.5	4015			70	REM00K2200-IE	200	130	REM00K5120-IE	120	200	
	2.2	4022				REM00K2120-IE	120	120	REM00K6100-IE	100	140	
	4.0	4040		35	REM00K4075-IE	75	140	REM00K9070-IE	70	150		
	5.5	4055					100	REM01K9070-IE	70	110		
	7.5	4075		24	REM00K6100-IE	100	50	REM02K1070-IE	70	75		
	11.0	4110					REM00K9070-IE	70	55	REM03K5035-IE	35	110
	15.0	4150		20	REM03K5035-IE	35	90	REM19K0030-IE	30	100		
	18.5	4185					75			85		
	22.0	4220		4015045-TE	16	-				REM19K0020-IE	20	95
	30.0	4300								15	125	
	37.0	4370		4017068-TE	11	-				REM38K0012-IE	15	100
	45.0	4450								10	100	
	55.0	4550		4035090-TE	8.5	-				2 × REM19K0020-IE	10	100
	75.0	4750								3 × REM19K0030-IE	10	75
90.0	4900	4070130-TE	5.5	-				2 × REM38K0012-IE	6	105		
110.0	411K	4090240-TE	3.2					-				3 × REM38K0012-IE
132.0	413K			105								

⑤ Computer software

Types	Model	Description	Installation
Software	CX-Drive	Computer software	Configuration and monitoring software tool
	CX-One	Computer software	Configuration and monitoring software tool
	€Saver	Computer software	Software tool for Energy Saving calculation

ALL DIMENSIONS SHOWN ARE IN MILLIMETERS.

To convert millimeters into inches, multiply by 0.03937. To convert grams into ounces, multiply by 0.03527.

Cat. No. SysCat_I116E-EN-05 In the interest of product improvement, specifications are subject to change without notice.