



Chipsmall Limited consists of a professional team with an average of over 10 year of expertise in the distribution of electronic components. Based in Hongkong, we have already established firm and mutual-benefit business relationships with customers from,Europe,America and south Asia,supplying obsolete and hard-to-find components to meet their specific needs.

With the principle of “Quality Parts,Customers Priority,Honest Operation,and Considerate Service”,our business mainly focus on the distribution of electronic components. Line cards we deal with include Microchip,ALPS,ROHM,Xilinx,Pulse,ON,Everlight and Freescale. Main products comprise IC,Modules,Potentiometer,IC Socket,Relay,Connector.Our parts cover such applications as commercial,industrial, and automotives areas.

We are looking forward to setting up business relationship with you and hope to provide you with the best service and solution. Let us make a better world for our industry!



Contact us

Tel: +86-755-8981 8866 Fax: +86-755-8427 6832

Email & Skype: info@chipsmall.com Web: www.chipsmall.com

Address: A1208, Overseas Decoration Building, #122 Zhenhua RD., Futian, Shenzhen, China



5

4

3

2

1

Description: D-Sub Hood, Plastic, H andh HS Series, 25 Pins
 Part No: 40-9725H,HS
 (40-9725-HS is the same as 40-9725-H, but with metalized plating)

DRAWING NO.
 40-9725H,HS-CUST

REVISIONS

01 OFFICIAL RELEASE

12-19-12	G Z	M W	M L	ECO-12-0335
----------	--------	--------	--------	-------------

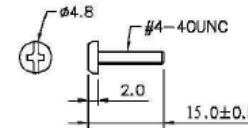
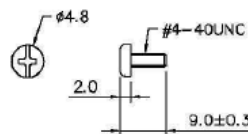
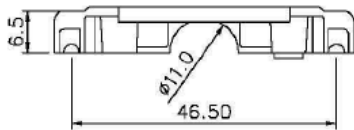
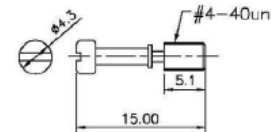
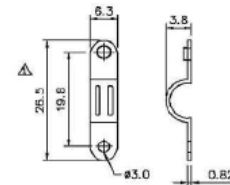
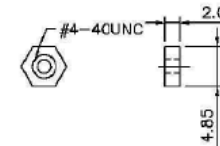
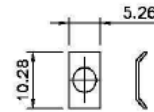
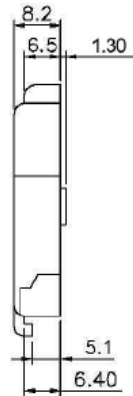
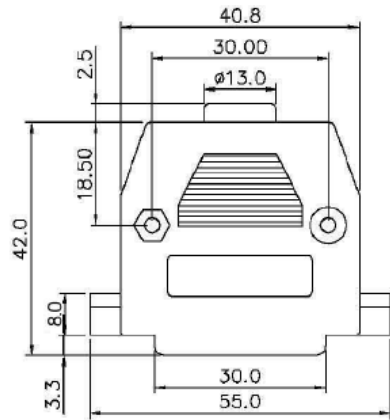

DIM OUTLINE

Hood Material: ABS,UL 94HB
 Color: Gray,Black,Ivory
 Screw Nut &Clip And Other ,Nickel Plated
 Plated:1Set/Bag

TOLERANCE UNLESS OTHERWISE SPECIFIED		DRAWN BY GARY.ZHG	DATE 12-19-12
DECIMALS	mm	CHECKED BY MONICA.W	DATE 12-19-12
X.X	+ 0.2	APPROVED BY MA LIN	DATE 12-19-12
X.XX	+ 0.1	U/M	mm
X.XXX	+0.08		
ANGLES	+ 0.5°		

CUSTOMER COPY



TITLE
 D-Sub Hood, Plastic, H Series, 25 Pins
 D-Sub Hood, Deluxe Metalized HS Series, 25 Pins

SHEET 1 OF 1	DRAWING NO. 40-9725H,HS-CUST	SIZE A
-----------------	---------------------------------	-----------

THIS DRAWING WAS PRODUCED BY COMPUTER,
 DO NOT SCALE DRAWING OR UPDATE MANUALLY.

5

4

3

2

1