



Chipsmall Limited consists of a professional team with an average of over 10 year of expertise in the distribution of electronic components. Based in Hongkong, we have already established firm and mutual-benefit business relationships with customers from,Europe,America and south Asia,supplying obsolete and hard-to-find components to meet their specific needs.

With the principle of “Quality Parts,Customers Priority,Honest Operation,and Considerate Service”,our business mainly focus on the distribution of electronic components. Line cards we deal with include Microchip,ALPS,ROHM,Xilinx,Pulse,ON,Everlight and Freescale. Main products comprise IC,Modules,Potentiometer,IC Socket,Relay,Connector.Our parts cover such applications as commercial,industrial, and automotives areas.

We are looking forward to setting up business relationship with you and hope to provide you with the best service and solution. Let us make a better world for our industry!



## Contact us

Tel: +86-755-8981 8866 Fax: +86-755-8427 6832

Email & Skype: info@chipsmall.com Web: www.chipsmall.com

Address: A1208, Overseas Decoration Building, #122 Zhenhua RD., Futian, Shenzhen, China



REV.	DESCRIPTION	DATE
A	RELEASE	2016.06.08

RoHS

**MATERIAL&FINISH**

Insulator: PBT Glass Fiber(UL94V-0)  
 Contact Material: Terminal Brass.  
 Contact Plating : Terminal Shell  
 Spec. Gold-Plated Over Nickel.

**SPECIFICATIONS**

Current Rating :1A AC, DC  
 Voltage Rating : 250V AC, DC  
 Temperature Range:-40° C To+105° C  
 Contact Resistance:20MΩ Max  
 Insulation Resistance:1000MΩ Min  
 Withstanding Voltage:500V AC/Min

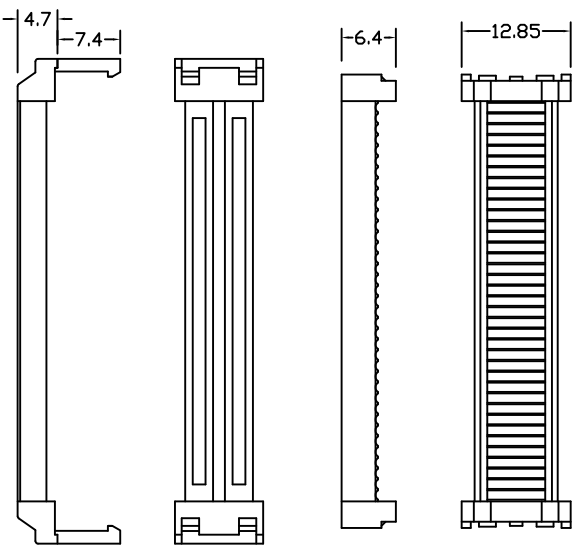
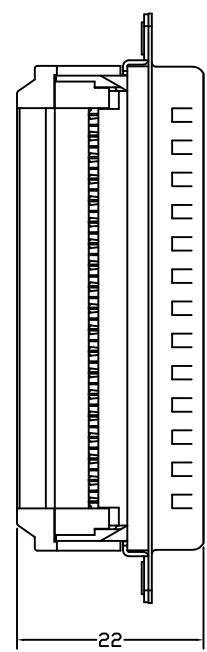
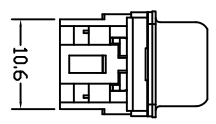
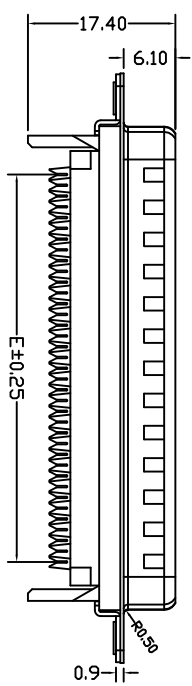
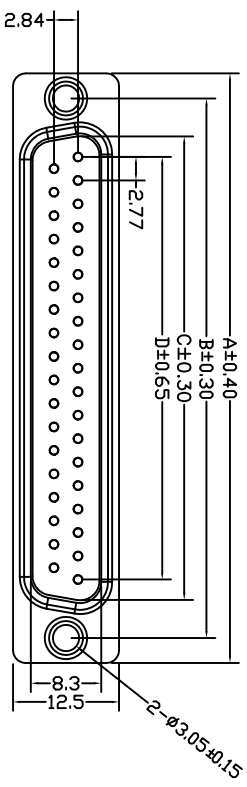

NUMBER OF POSITIONS	DIMENSION				
	A	B	C	D	E
9	30.80	25.00	16.95	11.08	10.16
15	39.14	33.30	25.3	19.39	17.78
25	53.05	47.04	38.96	33.24	30.48
37	69.32	63.50	55.42	49.86	45.72

UNLESS TOLERANCE

GENERAL	ANGLE	DRAW BY
X. ± 0.30	X°. ± 3.0°	DESIGN BY
.XX ± 0.20	.XX' ± 2.0'	CHECK BY
.XXX ± 0.15	.XXX' ± 1.0'	APPROVE BY
.XXX ± 0.08	.XXX ± 0.5'	

**CnC Tech,LLC**

Part NO.  
400MD-XX-1-004S

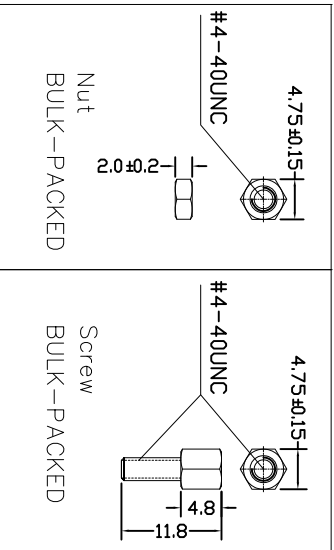
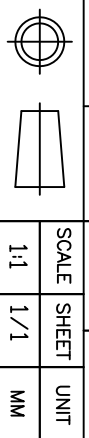

SCALE	SHEET	UNIT	DRW NO:	REV: A
1:1	1/1	MM		