



Chipsmall Limited consists of a professional team with an average of over 10 year of expertise in the distribution of electronic components. Based in Hongkong, we have already established firm and mutual-benefit business relationships with customers from,Europe,America and south Asia,supplying obsolete and hard-to-find components to meet their specific needs.

With the principle of “Quality Parts,Customers Priority,Honest Operation,and Considerate Service”,our business mainly focus on the distribution of electronic components. Line cards we deal with include Microchip,ALPS,ROHM,Xilinx,Pulse,ON,Everlight and Freescale. Main products comprise IC,Modules,Potentiometer,IC Socket,Relay,Connector.Our parts cover such applications as commercial,industrial, and automotives areas.

We are looking forward to setting up business relationship with you and hope to provide you with the best service and solution. Let us make a better world for our industry!



Contact us

Tel: +86-755-8981 8866 Fax: +86-755-8427 6832

Email & Skype: info@chipsmall.com Web: www.chipsmall.com

Address: A1208, Overseas Decoration Building, #122 Zhenhua RD., Futian, Shenzhen, China



PE4244

SPDT UltraCMOS™ RF Switch

Features

- Single +3.0-volt Power Supply
- Low Insertion loss: 0.60 dB up to 2.0 GHz
- High isolation of 39 dB at 1.0 GHz, 29 dB at 2.0 GHz
- Typical 1 dB compression of +27 dBm
- Single-pin CMOS logic control
- Packaged in 8-lead MSOP

Product Description

The PE4244 UltraCMOS™ RF Switch is designed to cover a broad range of applications from DC to 3.0 GHz. This switch integrates on-board CMOS control logic with a low voltage CMOS compatible control input. Using a +3-volt nominal power supply voltage, a 1 dB compression point of +27 dBm can be achieved. The PE4244 also exhibits excellent isolation of 39 dB at 1.0 GHz and is offered in a small 8-lead MSOP package.

The PE4244 UltraCMOS™ RF Switch is manufactured in Peregrine's patented Ultra Thin Silicon (UTSi®) CMOS process, offering the performance of GaAs with the economy and integration of conventional CMOS.

Figure 1. Functional Diagram

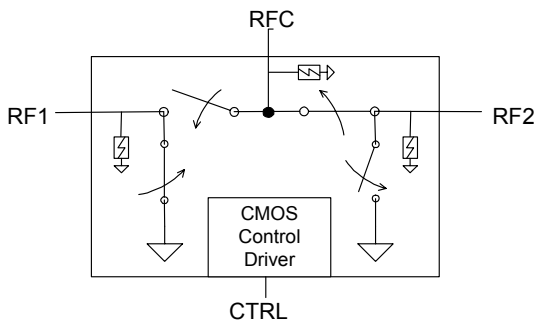

Figure 2. Package Type

8-lead MSOP

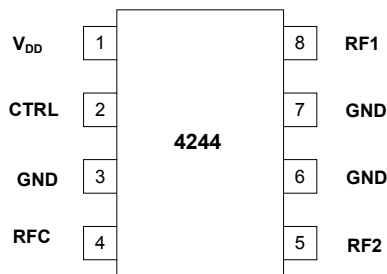

Table 1. Electrical Specifications @ +25 °C, V_{DD} = 3 V (Z_S = Z_L = 50 Ω)

Parameter	Conditions	Minimum	Typical	Maximum	Units
Operation Frequency ¹		DC		3000	MHz
Insertion Loss	1000 MHz		0.60	0.75	dB
	2000 MHz		0.60	0.75	dB
Isolation – RFC to RF1/RF2	1000 MHz	37	39		dB
	2000 MHz	27	29		dB
Isolation – RF1 to RF2	1000 MHz	34	36		dB
	2000 MHz	26	28		dB
Return Loss	1000 MHz	19	20		dB
	2000 MHz	22	25		dB
'ON' Switching Time	CTRL to 0.1 dB final value, 2 GHz		200		ns
'OFF' Switching Time	CTRL to 25 dB isolation, 2 GHz		90		ns
Video Feedthrough ²			15		mV _{pp}
Input 1 dB Compression	2000 MHz	26	27		dBm
Input IP3	2000 MHz, 14dBm	43	45		dBm

Notes: 1. Device linearity will begin to degrade below 10 MHz.

2. The DC transient at the output of any port of the switch when the control voltage is switched from Low to High or High to Low in a 50 Ω test set-up, measured with 1ns risetime pulses and 500 MHz bandwidth.

Figure 3. Pin Configuration (Top View)

Table 2. Pin Descriptions

Pin No.	Pin Name	Description
1	V _{DD}	Nominal 3 V supply connection. A bypass capacitor (100 pF) to the ground plane should be placed as close as possible.
2	CTRL	CMOS logic level: High = RFC to RF1 signal path
3	GND	Ground connection. Traces should be physically short and connected to
4	RFC	Common RF port for switch (Note 1)
5	RF2	RF2 port (Note 1)
6	GND	Ground Connection. Traces should be physically short and connected to
7	GND	Ground Connection. Traces should be physically short and connected to
8	RF1	RF1 port (Note 1)

Note 1: All RF pins must be DC blocked with an external series capacitor or held at 0 V_{DC}.

Table 3. Absolute Maximum Ratings

Symbol	Parameter/Conditions	Min	Max	Units
V _{DD}	Power supply voltage	-0.3	4.0	V
V _I	Voltage on any input	-0.3	V _{DD} +	V
T _{ST}	Storage temperature range	-65	150	°C
T _{OP}	Operating temperature	-40	85	°C
P _{IN}	Input power (50Ω)		30	dBm
V _{ESD}	ESD voltage (Human Body)		1500	V

Absolute Maximum Ratings are those values listed in the above table. Exceeding these values may cause permanent device damage. Functional operation should be restricted to the limits in the DC Electrical Specifications table. Exposure to absolute maximum ratings for extended periods may affect device reliability.

Table 4. DC Electrical Specifications

Parameter	Min	Typ	Max	Units
V _{DD} Power Supply Voltage	2.7	3.0	3.3	V
I _{DD} Power Supply Current V _{DD} = 3V, V _{CTRL} = 3V		250	500	nA
Control Voltage High	0.7xV _{DD}			V
Control Voltage Low			0.3xV _{DD}	V

Electrostatic Discharge (ESD) Precautions

When handling this UltraCMOS™ device, observe the same precautions that you would use with other ESD-sensitive devices. Although this device contains circuitry to protect it from damage due to ESD, precautions should be taken to avoid exceeding the specified rating.

Latch-Up Avoidance

Unlike conventional CMOS devices, UltraCMOS™ devices are immune to latch-up.

Table 5. Control Logic Truth Table

Control Voltage	Signal Path
CTRL = CMOS High	RFC to RF1
CTRL = CMOS Low	RFC to RF2

Evaluation Kit

The SPDT Switch Evaluation Kit board was designed to ease customer evaluation of the PE4244 SPDT switch. The RF common port is connected through a 50 Ω transmission line to the top left SMA connector, J1. Port 1 and Port 2 are connected through 50 Ω transmission lines to the top two SMA connectors on the right side of the board, J3 and J4. A through transmission line connects SMA connectors J6 and J8. This transmission line can be used to estimate the loss of the PCB over the environmental conditions being evaluated.

The board is constructed of a two metal layer FR4 material with a total thickness of 0.031". The bottom layer provides ground for the RF transmission lines. The transmission lines were designed using a coplanar waveguide with ground plane model using a trace width of 0.030", trace gaps of 0.007", dielectric thickness of 0.028", metal thickness of 0.0014" and ϵ_r of 4.4.

J2 provides a means for controlling DC and digital inputs to the device. Starting from the lower left pin, the second pin to the right (J2-3) is connected to the device CTRL input. The fourth pin to the right (J2-7) is connected to the device V_{DD} input. A decoupling capacitor (100 pF) is provided on both CTRL and V_{DD} traces. It is the responsibility of the customer to determine proper supply decoupling for their design application. Removing these components from the evaluation board has not been shown to degrade RF performance.

Figure 4. Evaluation Board Layout

Peregrine specification 101/0037

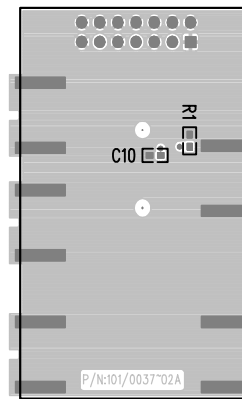
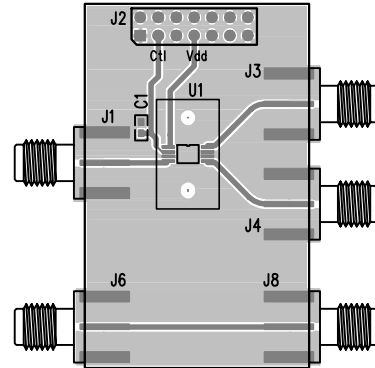
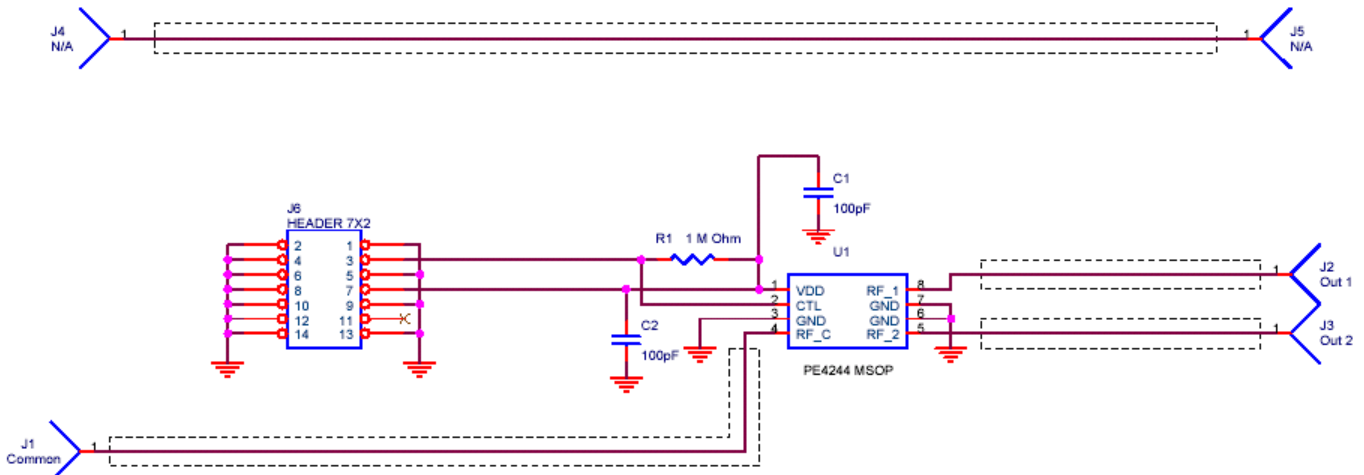

Figure 5. Evaluation Board Schematic

Peregrine specification 101/0147



Typical Performance Data @ -40 °C to 85 °C (Unless otherwise noted)

Figure 6. Insertion Loss – RFC to RF1

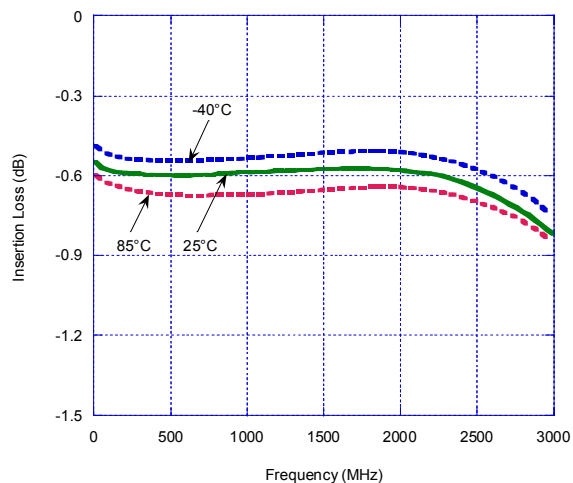

Figure 7. Input 1 dB Compression Point & IIP3

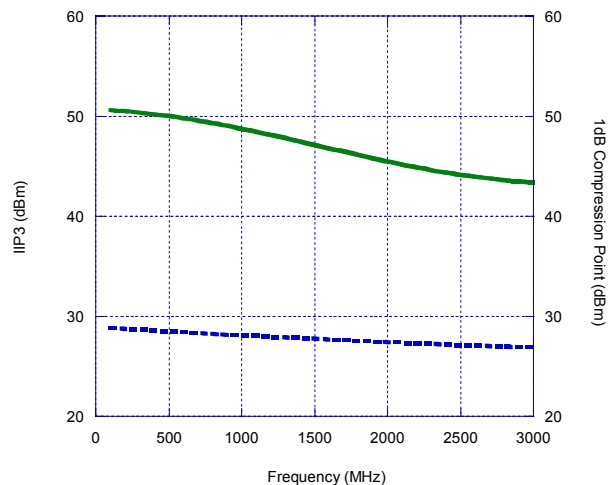

Figure 8. Insertion Loss – RFC to RF2

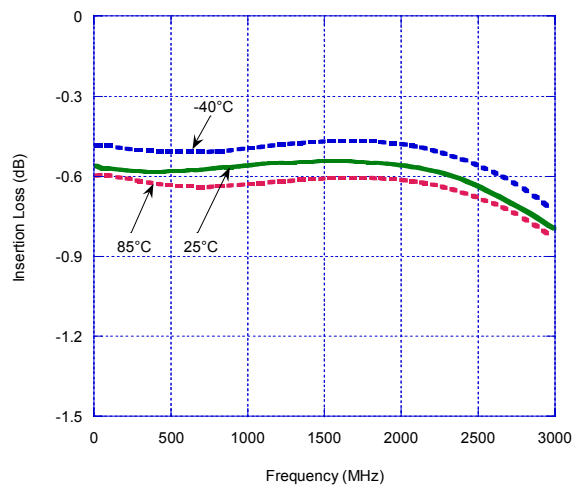
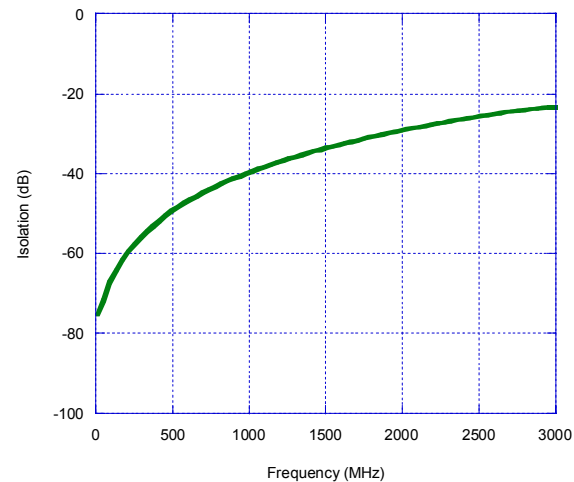

Figure 9. Isolation – RFC to RF1



Typical Performance Data @ -40 °C to 85 °C (Unless otherwise noted)

Figure 10. Isolation – RFC to RF2

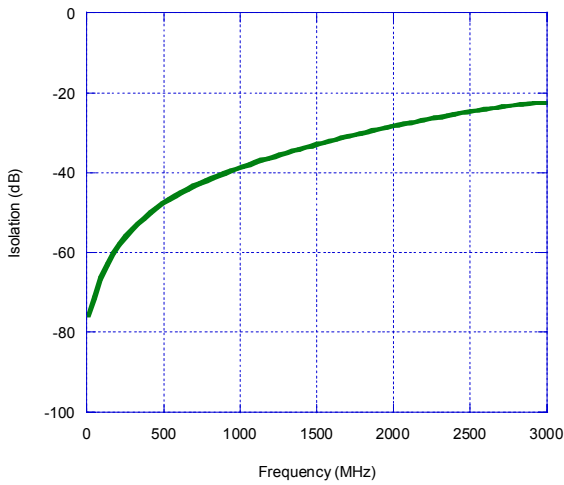

Figure 11. Isolation – RF1 to RF2, RF2 to RF1

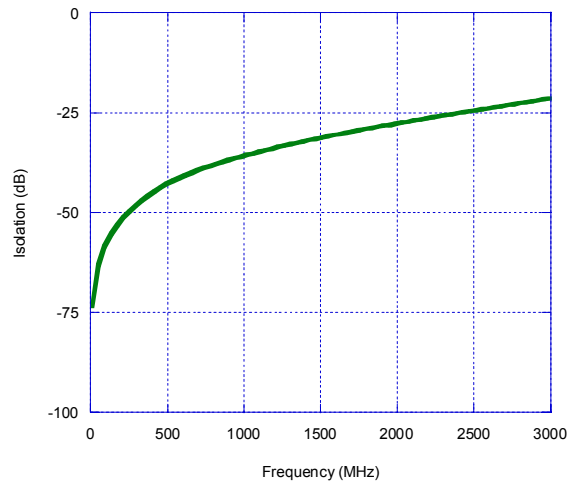

Figure 12. Return Loss – RFC to RF1, RF2

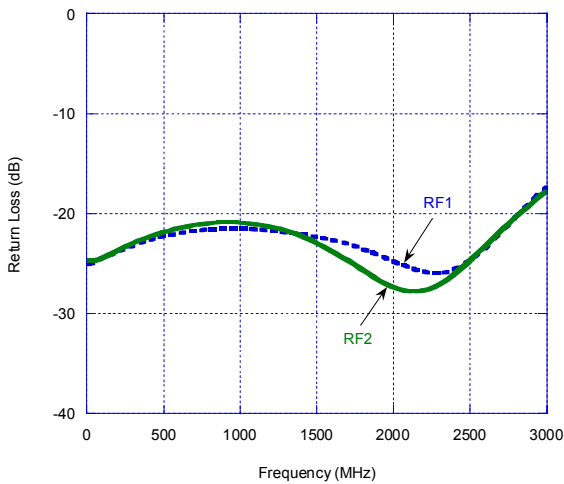

Figure 13. Return Loss – RF1, RF2

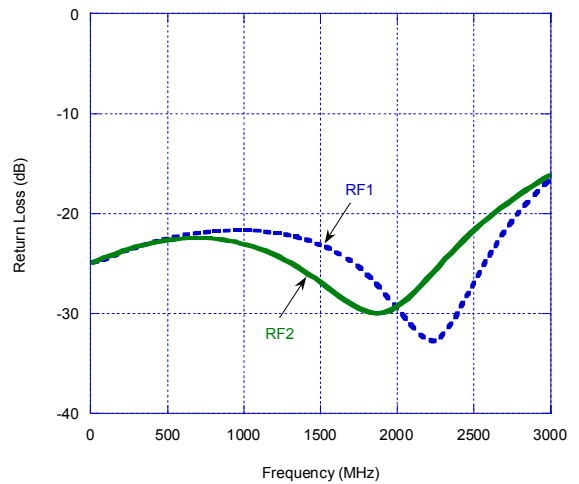

Figure 14. Package Drawing

8-lead MSOP

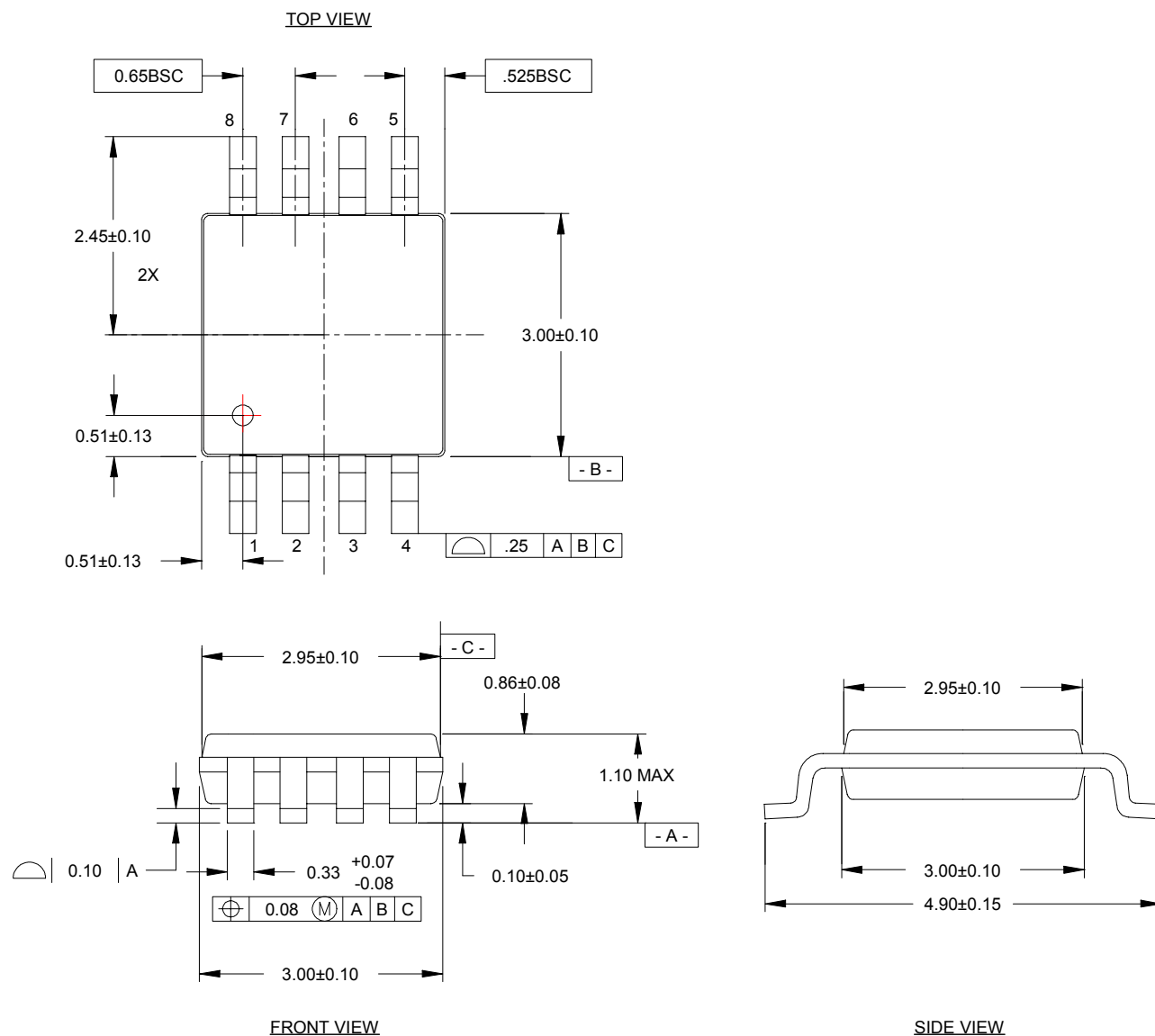

Table 6. Ordering Information

Order Code	Part Marking	Description	Package	Shipping Method
4244-01	4244	PE4244-08MSOP-50A	8-lead MSOP	50 units / Tube
4244-02	4244	PE4244-08MSOP-2000C	8-lead MSOP	2000 units / T&R
4244-00	PE4244-EK	PE4244-08MSOP-EK	Evaluation Kit	1 / Box
4244-51	4244	PE4244G-08MSOP-50A	Green 8-lead MSOP	50 units / Tube
4244-52	4244	PE4244G-08MSOP-2000C	Green 8-lead MSOP	2000 units / T&R

Sales Offices

The Americas

Peregrine Semiconductor Corp.

9450 Carroll Park Drive
San Diego, CA 92121
Tel 858-731-9400
Fax 858-731-9499

Europe

Peregrine Semiconductor Europe

Commercial Products:

Bâtiment Maine
13-15 rue des Quatre Vents
F- 92380 Garches, France
Tel: +33-1-47-41-91-73
Fax : +33-1-47-41-91-73

Space and Defense Products:

180 Rue Jean de Guiramand
13852 Aix-En-Provence cedex 3, France
Tel: +33(0) 4 4239 3361
Fax: +33(0) 4 4239 7227

North Asia Pacific

Peregrine Semiconductor K.K.

5A-5, 5F Imperial Tower
1-1-1 Uchisaiwaicho, Chiyoda-ku
Tokyo 100-0011 Japan
Tel: +81-3-3502-5211
Fax: +81-3-3502-5213

South Asia Pacific

Peregrine Semiconductor

28G, Times Square,
No. 500 Zhangyang Road,
Shanghai, 200122, P.R. China
Tel: +86-21-5836-8276
Fax: +86-21-5836-7652

For a list of representatives in your area, please refer to our Web site at: www.psemi.com

Data Sheet Identification

Advance Information

The product is in a formative or design stage. The data sheet contains design target specifications for product development. Specifications and features may change in any manner without notice.

Preliminary Specification

The data sheet contains preliminary data. Additional data may be added at a later date. Peregrine reserves the right to change specifications at any time without notice in order to supply the best possible product.

Product Specification

The data sheet contains final data. In the event Peregrine decides to change the specifications, Peregrine will notify customers of the intended changes by issuing a DCN (Document Change Notice).

The information in this data sheet is believed to be reliable. However, Peregrine assumes no liability for the use of this information. Use shall be entirely at the user's own risk.

No patent rights or licenses to any circuits described in this data sheet are implied or granted to any third party.

Peregrine's products are not designed or intended for use in devices or systems intended for surgical implant, or in other applications intended to support or sustain life, or in any application in which the failure of the Peregrine product could create a situation in which personal injury or death might occur. Peregrine assumes no liability for damages, including consequential or incidental damages, arising out of the use of its products in such applications.

The Peregrine name, logo, and UTSi are registered trademarks and UltraCMOS is a trademark of Peregrine Semiconductor Corp.